

# INDUSTRIAL

HOSE, COUPLINGS + EQUIPMENT



2017 PRODUCTS CATALOG





# TERMS + CONDITIONS

## TERMS POLICY

Terms are 2%, 30 days. Discount may be earned if paid on or prior to the 30th day following the invoice date.

## CONDITIONS

- › Prices do not include charges for special packaging, which will be extra, unless otherwise specified.
- › Prices are subject to change without notice.
- › Buyer shall reimburse Seller for all taxes, excise or other charges. Seller may be required to pay to any government (Federal, State or Local) upon the sales, use, production, or transportation of the merchandise sold hereunder.
- › Seller shall be excused and not liable for delays caused by Buyer's request, labor troubles, shortages in materials, damage to plant, government regulations, or other cause, similar to otherwise beyond Seller's control.

Gates Standard Terms and Conditions of Sale can be viewed at [www.gates.com/termsofsale](http://www.gates.com/termsofsale).

# Table of Contents

---

<b>Description</b>	<b>Page</b>
Index of Industrial Hoses by Specification .....	2
Index of Industrial Hoses by Name .....	3
Index of Industrial Hoses by Application .....	4
Index of Industrial Hose by Product Number .....	6
Packaging Code Reference .....	11
What's New .....	13
Efficiency. Engineered. ....	15
Gates Tube & Cover Materials .....	17
Industrial Hose Name Finder .....	18
Performance Level .....	19
Gates Cut Length Program .....	20
Gates Industrial Hose Programs .....	21
Gates Authorized E2E Distributors .....	22
Gates Safety Training .....	23
Certifications and Standards .....	24
Where To Buy .....	25
Industrial Hose Crimpers and Selection Guide .....	26
Definitions & Abbreviations .....	28
Selection of Hoses & Couplings .....	29
ARPM Tolerances .....	31
Care and Maintenance of Hose .....	32
Gates Engineering & Services .....	35
<b>Industrial Hose</b>	
Agriculture Hose .....	36
Air Breathing Hose .....	43
Air Duct .....	46
Air and Multi-Purpose Hose .....	48
Chemical Hose .....	60
Food and Beverage Hose .....	70
Marine Hose .....	83
Material Handling Hose .....	100
Mining Hose .....	106
Oilfield Hose .....	112
Petroleum Transfer Hose .....	135
Pressure Wash / Washdown Hose .....	152
Steam Hose .....	158
Water Hose .....	160
<b>Industrial Couplings</b>	
Clamps .....	169
Couplings and Ferrules .....	171
<b>Technical Information</b>	
Hose Finder .....	192
Chemical Resistance Table & Characteristics of Hose Stock Types .....	218

## Index of Industrial Hose by Specification

Spec	Page	Spec	Page	Spec	Page
3129BG	120	3605	158	4686ME	93
3129F, H, L	100	3618, GL	109	4687R	141
3131	74	3618, Y	110	4688AC, AF	135
3132C	71	3618MT	108	4688BG	123, 132
3132C, H	70	3619M	106	4688CC, DC	137
3132D	77	3619MC, MY	107	4688CN	140
3132LW	72	3624	150	4688F	138
3132OP	117	3624G	151	4688HF	133
3132P	118	3624TN	69	4688LT	139
3132PW	116	3658F	95	4688RF	136
3133	73	3670H, 4651XL, ZL	115	4688SH	130
3133F	75	4040A	99	4688SS	127
3135SP	163	4110DW	121	4688V, VN	122
3137BG	114	4110HF	134	4688VF	124
3137M	164	4110MT, SH	131	4689BG	125
3137ME	92	4110SS	128	4691BG	119
3137T	165	4110UB	129	4691HA, HC	102
3150BG	126	4129A	104	4691L	101
3200B, R	54	4169A	88	4691RD	111
3202T, TW	49	4171	90	4691V	103
3204	38	4175EC	86	4693B	76
3204BL, E, GR, S, SB, YL	55-57	4176HD	87	4695, G	62
3204E, EB, S, SB	58	4217IS	68	4695BG	112
3205AR	52	4218AC, AY	44	4695M	63
3205R	51	4219BF	84	4696A	66
3207T	67	4219BG	83	4696CP	65
3213B, 3325T	157	4219G	97	4697G	64
3217HY	156	4219M	96	4698B	60
3219AB, AR	48	4230T	91	4698MB	61
3220E	149	4465	36-37	7408	169
3220LP, SP, 3320	148	4657, KB, KG, KK, KR, KY, PB, PG, PY	152-153	7422	170
3221FR	146-147	4657F, XB, XG, XY	154	7744	40-42, 78-82, 105, 142, 144, 166-168
3222B, BK, G, GY, R, Y	53	4663A	46		
3232	45	4663J	47		
3237A	59	4663K	98		
3284D, E, G, H, R, Y	50	4684CF	94		
3333	43	4685WG	89		
3336E, 3336S	85	4686	162		
3602EL	159	4686AR, DC	160		
3603PW	155	4686AT	39, 161		
		4686BS	113		

## Index of Industrial Hose by Name

Name	Page	Name	Page	Name	Page
4169A Coolant Hose	88	Chem Master™ DEF Transfer 350	68	GLX® - FSX 45° SAE Female Swivel	173
4175EC Coolant Hose	86	Chem Master™ EPDM (125-150) SD	66	GLX® - Male Pipe (NPTF 30° Cone Seat)	171
4176HD Coolant Hose	87	Chem Master™ Hydrocarbon Drain 250	69	GLX® - MPX Male NPTF Swivel	174
4219BF Barricade® Fuel Injection Fuel Hose	84	Chem Master™ Paint Spray (500-750)	67	GLX® - MS 45° SAE Male Solid	172
225	84	Chem Master™ Plus CPE (150-200) SD	65	Green Stripe® Coolant and Air Hose	89
4219BG Barricade® Fuel Hose (35-50)	83	MegaFlex®	65	GSM™ with Integral 2" Fig. 1502 Hammer	178
4219G Fuel Line (35-50)	97	Chem Master™ Plus UHMWPE (125-200) SD	64	Unions	170
4219M Marine Master™ Fuel Line 40	96	Chem Master™ Plus XLPE (150-200) SD	62	Heavy-Duty T-Bolt Clamps	170
4230T Coolant Hose	91	Clean Master™ Plus XLPE 200SD CR	63	LP350	148
4663K Fuel Fill Hose - Corrugated	98	Chem Master™ XTreme™ FEP (125-200) SD	60	LPG Vapor 125	149
Ag Master™ (200-250)	38	Chem Master™ XTreme™ FEP 200SD CR	61	Marine Master™ Plus Wet Exhaust (15-100) SD	94
Ag Master™ PVC Solution (30-90) SD Clear	42	Clean Master™ Pressure Wash (2500-3000)	152	Marine Master™ Wet Exhaust 100D	92
Ag Master™ PVC Solution (35-80) SD	41	Clean Master™ Pressure Wash (3500-4000)	153	Marine Master™ Wet Exhaust 100SD	93
Ag Master™ PVC XTreme™ (90-100) SD	40	Clean Master™ Pressure Wash (4000-6000)	154	MIL Low Pressure Fuel & Oil Hose	85
Ag Master™ Solution 150SD	39	Clean Master™ Pressure Wash Assemblies	155	Mine Master™ Air Drill 500	109
Ag Master™ Spray 600	36	Clean Master™ Washdown	157	Mine Master™ Air Drill 500 FR	110
Ag Master™ Spray 800	37	Clean Master™ Washdown 1000	156	Mine Master™ Air Drill 600HT	108
Air Duct (5-10) SD	46	Engine Coolant Silicone	90	Mine Master™ Longwall Emulsion 1000	107
Air Duct (8-20) SD	47	Food Master® Beverage 150SD CR	72	Mine Master™ Rock Dust 100SD	111
Air Master™ Diving Air Hose Couplings	179	Food Master® Beverage 250SD CR	71	Mine Master™ Spray 1000	106
Air Master™ Diving Umbilical (1000-1125)	43	Food Master® Dry Goods (25-40) D	77	Plant Master® (150-200)	58
Air Master™ Respirator 500	45	Food Master® Dry Goods (50-150) SD	76	Plant Master® 250 Black	56
Air Master™ SCUBA 500	44	Food Master® Oils and Dairy 150D	74	Plant Master® 250 Colors	57
Black Gold® ABS Bulk Material (250-300) D	120	Food Master® Oils and Dairy 150SD	73	Plant Master® 300	55
Black Gold® ABS Bulk Material 300SD	119	Food Master® Oils and Dairy 150SD	75	Plant Master® 300 NC	59
Black Gold® ABS Chemical Plus XLPE 250SD	112	MegaFlex®	75	Plant Master® Plus (200-300)	54
Black Gold® ABS Drill Water 300D	114	Food Master® PVC (20-65) Clear	78	Plant Master® Plus 300 Lock-On	53
Black Gold® ABS Drill Water 300SD	113	Food Master® PVC (35-50) SD Clear	81	Plant Master® Steam 250	158
Black Gold® ABS Mud and Oil 300D	126	Food Master® PVC (50-100) SD Clear	80	Plant Master® Steam Plus 250	159
Black Gold® ABS Mud and Oil 300SD	125	Food Master® PVC Clear Tubing (75-250) Braid	79	Plant Master® XTreme™ (250-315)	51
Black Gold® ABS Potable Water 300D	117	Food Master® PVC Dry Goods (35-40) SD	82	Plant Master® XTreme™ 300 AR	52
Black Gold® ABS Potable Water 300SD	116	Clear	82	Plant Master® XTreme™ 300 Lock-On Braid	50
Black Gold® ABS Potable Water 300SD	121	Food Master® XTreme™ 250SD CR	70	Plant Master® XTreme™ 325 Braid	48
Black Gold® Blender Transfer 150D	128	Fuel Master™ 100SD	141	Plant Master® XTreme™ 501 AR	49
Black Gold® Fuel 300D	127	Fuel Master™ 150D	140	Stainless Steel Clamps	169
Black Gold® Fuel 300SD	127	Fuel Master™ 150SD	137	Water Master® (90-150) D	165
Black Gold® Oilfield Frac 400D	134	Fuel Master™ 150SD LT MegaFlex®	139	Water Master® (100-150) SD	161
Black Gold® Oilfield Frac 400SD	133	Fuel Master™ 150SD MegaFlex®	138	Water Master® (100-150) SD AR	160
Black Gold® Oilfield Service (100-150) SD	132	Fuel Master™ Curb Pump 150	150	Water Master® 150D AR	164
Black Gold® Oilfield Service 400D	131	Fuel Master™ Delivery 200	146	Water Master® Plus PVC Layflat (100-150) D	168
Black Gold® Oilfield Service 400D	129	Fuel Master™ Delivery 200 Assemblies	147	Water Master® PVC (40-100) SD	166
UltraBration®	129	Fuel Master™ Diesel Curb Pump 150	151	Water Master® PVC Layflat (45-75) D	167
Black Gold® Oilfield Service 400SD	130	Fuel Master™ PVC 65SD	142	Water Master® Slurry 150D AR	163
Black Gold® Oilfield Vacuum (100-150) SD	123	Fuel Master™ PVC 65SD Sleeve	143	Water Master® Water Suction/Discharge	162
Black Gold® Potable Water (150-300) D	118	Fuel Master™ PVC Vapor Recovery 5SD	144	150SD	162
Black Gold® Slim Hole Rotary (1500-5000)	115	Fuel Master™ PVC Vapor Recovery 5SD	145	Windshield Washer and Vacuum Tubing	99
Black Gold® Super-Vac® (60-150) SD	122	Sleeve	145		
Black Gold® Super-Vac® MegaFlex® (100-200) SD	124	Fuel Master™ XTreme™ 150SD	135		
Bulk Master™ (4-24) SD	103	Fuel Master™ XTreme™ 150SD MegaFlex®	136		
Bulk Master™ Dry Cement (20-75) D	100	GLX® - Female JIC 37° Flare Swivel	177		
Bulk Master™ Hot Air Blower (40-130) SD HT	102	GLX® - FP Female NPTF Solid	175		
Bulk Master™ Plus (35-60) SD	101	GLX® - FPX Female NPSM Swivel	176		
Bulk Master™ PVC (25-40) SD AR	105				
Bulk Master™ Sand Blast (120-150) D	104				
C5M Marine Fuel Line Hose	95				

## Index of Industrial Hose by Application

Subject	Page	Subject	Page
<b>A</b>			
Abrasion Resistant .....	49, 52, 119-120, 125-126, 129	<b>H Continued.</b>	
ABS .....	95, 112, 114, 116-117	Heavy-Duty Water .....	160, 163-164, 166
Acid-Chemical .....	36-37, 40, 60-64, 66-67, 78, 112	Herbicide Transfer .....	36-38, 40, 42
Acid-Suction .....	36-37, 40, 60-64, 66-67, 112	High Pressure Air .....	106, 108-110, 115
Agricultural Spray .....	36-38	High Pressure Chemical .....	112
Agricultural Water .....	42, 160-168	High Pressure Washer .....	152-157
Air .....	46-59, 106-110	High Pressure Water .....	152-156
Air Blower .....	46-47	High Temperature Air .....	108
Air Breathing .....	43, 45	High Temperature Water .....	69
Air Drill .....	108-110	Hot Air Blower .....	102
Air Duct .....	46-47, 105	Hydraulic Fracturing .....	121, 127, 129-133
Air Tools .....	48, 51-52, 54-58, 106-107	Hydrocarbon Drain .....	69
Ammonia Applicator .....	55-58	<b>I</b>	
Aromatic Gasolines .....	127-128, 130-131, 135-142, 146, 150-151	Industrial Air .....	46-58, 106-110, 115
ARPM (Assoc. for Rubber Products Mfgs.) .....	41, 48-58, 86-88, 94-95, 98, 105, 159	Industrial Couplings .....	171-178
Automotive Coolant .....	86-87	Industrial Steam .....	158-159
<b>B</b>		Industrial Water .....	42, 48-54, 56-58, 86-87, 106-107, 156-157, 160-168
Barite .....	119-120	Insecticide Transfer .....	36-38, 40, 42
Beverage .....	70-82	Insulation Handling .....	103, 105
Bio-Diesel .....	67, 83-84, 135	<b>L</b>	
Blast or Shot Hole .....	115	Layflat Hose .....	167-168
Breathing Air .....	43, 45	Leaf Collector .....	103, 105
Brewery .....	70-72	Lightweight Water .....	42, 86-87, 161-162, 165, 167
Bulk Materials .....	41, 70-77, 80-82, 100-105	Low Temperature Fuel .....	139
Butane .....	148-149	LP Gas (UL-21) .....	148
<b>C</b>		LPG Vapor .....	149
Cement .....	100-101, 119-120	Lube Oil Transfer .....	48-50, 135-141
Chemical Cleanup .....	60-64, 66-67, 112	<b>M</b>	
Cleanup .....	48, 152-154, 156-157	Marine .....	169
Compressed Air .....	48-58, 106, 110, 115	Marine Wet Exhaust .....	86-87, 92-94
Coolant .....	86-90, 94	Material Handling .....	41, 100-105, 119-120
Coolant Low Pressure .....	170	Medium Duty Water .....	168
Couplings .....	171-178	MIL-SPEC .....	85
Creamery Washdown .....	157	Mining .....	49, 106-107, 110-111
Cross-Linked Polyethylene .....	60-63, 112	MSHA (Mining Safety and Health Admin.) .....	49, 106-107, 110, 115
Crude Oil .....	122-124	Multi-Purpose .....	43, 46-54, 56-59, 108, 115
Curb Pump (UL-330) .....	146, 150-151	<b>N</b>	
<b>D</b>		Natural Gas .....	148
Debris Collecting .....	41, 101, 103, 105	Non-Conductive .....	48-49, 51-53, 59
DEF (Diesel Exhaust Fluid) .....	68	Non-Oil Chemicals .....	118
Dewatering .....	40, 160-168	Nylon .....	67
Dilute Acids .....	121	<b>O</b>	
Distillate Transfer .....	135-142, 144	Offshore Drilling .....	112-114, 116-117, 119-120, 125-131
Divers' Air .....	43	Oil Resistance .....	54, 159
Drilling .....	108	Oilfield .....	113-117, 119-134
Drilling Air .....	108	Oxygen .....	43, 48, 51-52
Drilling Mud .....	122-126, 129-132	<b>P</b>	
Drilling Rig or Platform .....	118	Paint Spray .....	67
Dust Collection .....	41, 46-47, 103, 105	Paper Mill Washdown .....	157
<b>E</b>		Pesticides .....	36-38, 40, 42
Edible Products Transfer .....	70-82	Petroleum .....	121-124, 127-132, 135-142, 144, 146, 148-151
Electric Resistance Ends .....	48-49, 53, 59	Phthalate-Free .....	73-75, 78
Engine Coolant .....	85-90, 94	Pneumatic Applications .....	48-58, 106-110, 115
Exhaust .....	92-94	Pot Room .....	48-49, 51-53, 59
<b>F</b>		Potable Water .....	70-72, 78-82, 116-118
FDA (U.S. Food and Drug Administration) .....	70-82, 116-117	Propane (UL-21) .....	148
FEP .....	60-61	<b>R</b>	
Fertilizer Transfer .....	36-38, 40-41, 48, 51-52, 54-58	Refueling .....	150-151
Food Handling .....	70-82	Resistance, Electrical .....	48-49, 51-53, 59
Fracking Hose .....	121, 129-134	Rock Dust .....	111
Fuel Feed, Filler .....	95-96	Rotary .....	115
Fuel Oil Transfer .....	135-142, 146	<b>S</b>	
Fuel Transfer .....	83-85, 123, 127-128, 130-131, 135-142, 144, 146, 150	SAE 20R .....	86-91, 94
<b>G</b>		SAE 30R .....	83-84, 95, 97
Gasoline Pump (UL-330) .....	150-151	SAE 30R5 .....	98
Gasoline Transfer .....	127-128, 130-131, 135-142, 146, 150-151	SAE 30R6 or SAE 30R7 .....	97
Gatron® .....	62-63, 112	SAE J1037 .....	99
General Purpose (See Air and Multi-Purpose) .....	43, 46-59, 106-108, 115	SAE J1527 .....	95-96
Grain Handling .....	75-77, 80-82, 101, 105	SAE J2006 .....	92-94
Grass Vacuuming .....	103, 105	Sand Blast .....	104
Gravity Feed .....	170	Sewage .....	41, 129, 131
<b>H</b>			



## Index of Industrial Hose by Application

Subject	Page
<b>S Continued.</b>	
Sewage Transfer .....	122-124, 130, 132
Sludge .....	101, 121-124, 129-132
Solvents .....	60-64, 66-67, 112
Steam .....	158-159
Superheated .....	158-159
<b>T</b>	
Tank Truck (Chemical) .....	60-64, 66, 112
Tank Truck (Food) .....	70-77, 80-82
Tank Truck (Petroleum) .....	122-124, 127-132, 135-142, 144, 146
Three A (3A Standards) .....	70-71, 73-75, 80
<b>U</b>	
Underwriters' Laboratories (UL) .....	148-151
USCG .....	95-96
USCG SAE J1942 .....	95
USDA .....	70-71, 73-74, 79-82
<b>V</b>	
Vacuum (Dry) .....	41, 105
Ventilating .....	46-47, 97, 105
<b>W</b>	
Washdown .....	48, 106, 152-157
Water .....	40, 42, 85, 113-114, 121, 160-168
Water Discharge .....	40, 42, 86-87, 114, 163-168
Water Suction .....	40-42, 113, 152-157, 160-162, 166
Water Suction and Discharge .....	40-42, 113, 152-157, 160-162
Water Well .....	115
Wet Exhaust .....	86-87, 92-94
Wine .....	70-72

## Index of Industrial Hose by Product Number

Number	Page	Number	Page	Number	Page	Number	Page
3129-0570	100	3135-2654	163	3200-0016	54	3204-1337	58
3129-0660	100	3135-2655	163	3200-0202	54	3204-1340	57
3129-0670	100	3135-2656	163	3200-0206	54	3204-1346	58
3129-0672	100	3135-2657	163	3200-0207	54	3204-1349	57
3129-0675	100	3135-2658	163	3200-0208	54	3204-1355	55
3129-0680	100	3135-2659	163	3200-0209	54	3204-1358	58
3129-0690	100	3135-2660	163	3200-0210	54	3204-1361	58
3129-0700	100	3135-2661	163	3200-0212	54	3204-1364	55
3129-0790	100	3137-0370	164	3200-0213	54	3204-1373	58
3129-1000	120	3137-0371	164	3200-0237	54	3204-1375	58
3129-1001	120	3137-0372	164	3200-1279	54	3204-1377	58
3129-1013	120	3137-0373	164	3200-5012	54	3204-1379	58
3129-1014	120	3137-0374	164	3201-1100	50	3204-1381	58
3131-0001	74	3137-0375	164	3201-1101	50	3204-1383	58
3131-0002	74	3137-0376	164	3201-1102	50	3204-1386	57
3131-0003	74	3137-0377	164	3201-1103	50	3204-1401	58
3131-0004	74	3137-0378	164	3201-1104	50	3204-1404	56
3131-0005	74	3137-0379	164	3201-1105	50	3204-1406	56
3131-0006	74	3137-0380	164	3201-1106	50	3204-1407	58
3132-0066	70	3137-0381	164	3201-1107	50	3204-1408	58
3132-0067	70	3137-0382	164	3201-1108	50	3204-1410	56
3132-0171	72	3137-0383	164	3201-1109	50	3204-1413	58
3132-0172	72	3137-0883	165	3201-1110	50	3204-1414	58
3132-0173	72	3137-0884	165	3201-1111	50	3204-1416	56
3132-0174	72	3137-0885	165	3201-1112	50	3204-1419	58
3132-0175	72	3137-0886	165	3201-1113	50	3204-1422	58
3132-0180	71	3137-0888	165	3201-1114	50	3204-1425	56
3132-0181	71	3137-0889	165	3201-1115	50	3204-1427	56
3132-0182	71	3137-0890	165	3201-1116	50	3204-1428	58
3132-0183	71	3137-0892	165	3201-1117	50	3204-1431	58
3132-0184	71	3137-0895	165	3201-1118	50	3204-1432	58
3132-0186	71	3137-0896	165	3201-1119	50	3204-1434	56
3132-0216	70	3137-0898	165	3201-1120	50	3204-1437	56
3132-0217	70	3137-0905	165	3201-1121	50	3204-1496	57
3132-0218	70	3137-1207	92	3201-1122	50	3204-1497	57
3132-0219	70	3137-1209	92	3201-1123	50	3204-1498	57
3132-0220	70	3137-1213	92	3201-1124	50	3204-1500	57
3132-0221	70	3137-1215	92	3201-1125	50	3204-1501	55
3132-0222	70	3137-1217	92	3201-1126	50	3204-1503	55
3132-0263	70	3137-1219	92	3201-1127	50	3204-1505	55
3132-0264	70	3137-1221	92	3201-1128	50	3204-1511	55
3132-0265	70	3137-1223	92	3201-1129	50	3204-1513	55
3132-0266	70	3137-1225	92	3202-0001	49	3204-1515	55
3132-0267	70	3137-1227	92	3202-0006	49	3204-1516	57
3132-0268	70	3137-1229	92	3202-0011	49	3204-1517	57
3132-0269	70	3137-1231	92	3202-0016	49	3204-1518	57
3132-0782	77	3137-1233	92	3202-0021	49	3204-1520	57
3132-0783	77	3137-1235	92	3202-0027	49	3204-1521	55
3132-0793	77	3137-1237	92	3202-0029	49	3204-1523	55
3132-0794	77	3137-1239	92	3202-0032	49	3204-1525	55
3132-0797	77	3137-1245	92	3202-0033	49	3204-1526	57
3132-0803	118	3137-1249	92	3202-0301	49	3204-1527	57
3132-0815	118	3137-1252	92	3202-0306	49	3204-1528	57
3132-0823	118	3137-1253	92	3202-0311	49	3204-1530	57
3132-0832	118	3137-1254	92	3202-0316	49	3204-1532	57
3132-5010	117	3137-1269	165	3202-0317	49	3204-1636	58
3132-5011	117	3137-1272	164	3204-0506	55	3204-1650	55
3132-5012	117	3137-1280	114	3204-0558	55	3204-1718	55
3132-5013	116	3137-1281	114	3204-0560	55	3204-1720	57
3132-5032	116	3137-1282	114	3204-0710	58	3204-1721	56
3132-5033	116	3137-1302	114	3204-0901	55	3204-1730	58
3133-0001	73	3137-1303	114	3204-1079	38	3204-1731	57
3133-0002	73	3150-0503	126	3204-1080	38	3204-1900	57
3133-0003	73	3150-0504	126	3204-1081	38	3204-4402	58
3133-0004	73	3150-0505	126	3204-1082	38	3204-4407	58
3133-0005	73	3150-0508	126	3204-1083	38	3204-4413	58
3133-0006	73	3150-0509	126	3204-1084	38	3204-4422	58
3133-0007	73	3200-0002	54	3204-1085	38	3204-4431	56
3133-0008	73	3200-0003	54	3204-1086	38	3204-4432	56
3133-0011	73	3200-0006	54	3204-1301	58	3204-4433	56
3133-0055	73	3200-0007	54	3204-1304	57	3204-5301	58
3133-0100	75	3200-0008	54	3204-1307	55	3204-5304	57
3133-0101	75	3200-0009	54	3204-1316	58	3204-5307	55
3133-0102	75	3200-0010	54	3204-1319	58	3204-5319	58
3133-0103	75	3200-0011	54	3204-1322	57	3204-5321	57
3133-0104	75	3200-0012	54	3204-1325	55	3204-5326	55
3135-2651	163	3200-0013	54	3204-1328	58	3204-5328	58
3135-2652	163	3200-0014	54	3204-1331	57	3204-5333	57
3135-2653	163	3200-0015	54	3204-1334	55	3204-5334	55



## Index of Industrial Hose by Product Number

Number	Page	Number	Page	Number	Page	Number	Page
3204-5337	58	3219-2930	48	3232-1002	45	3618-0225	109
3204-5341	57	3219-2932	48	3237-0704	59	3618-0311	108
3204-5346	58	3219-2933	48	3237-0705	59	3618-0312	108
3204-5349	57	3219-2935	48	3237-0706	59	3618-0313	108
3204-5355	55	3219-2937	48	3237-0708	59	3618-0314	108
3204-5415	57	3219-2938	48	3320-0934	148	3618-0315	108
3204-5420	57	3219-2940	48	3320-0935	148	3618-0333	108
3204-5661	55	3220-0451	149	3320-0938	148	3618-0336	108
3204-5675	55	3220-0456	149	3320-0939	148	3618-0801	110
3204-5820	56	3220-0461	149	3333-0015	43	3618-0802	110
3205-0010	51	3220-0855	148	3333-0017	43	3618-0803	110
3205-0015	51	3220-1200	148	3333-0035	43	3618-0804	110
3205-0016	51	3220-1201	148	3333-0038	43	3618-0805	110
3205-0020	51	3220-1202	148	3333-0052	43	3618-0806	110
3205-0021	51	3220-1203	148	3333-0053	43	3618-0807	110
3205-0025	51	3220-1204	148	3333-0221	43	3618-0808	110
3205-0026	51	3220-1205	148	3333-0222	43	3618-0809	110
3205-0030	51	3220-1206	148	3336-0359	85	3618-0810	110
3205-0031	51	3220-1207	148	3336-0364	85	3618-0811	110
3205-0035	51	3220-1208	148	3336-0369	85	3618-0812	110
3205-0036	51	3220-1209	148	3336-0374	85	3618-0813	110
3205-0040	51	3220-1210	148	3336-0379	85	3618-0814	110
3205-0041	51	3220-1211	148	3336-0384	85	3618-1000	109
3205-0046	51	3220-1212	148	3336-0389	85	3619-0051	107
3205-0049	51	3220-1213	148	3336-0394	85	3619-0699	106
3205-0055	51	3220-1216	148	3336-0399	85	3619-0700	106
3205-0215	51	3221-0075	147	3336-0414	85	3619-0701	106
3205-0216	51	3221-0076	147	3336-0419	85	3619-0702	106
3205-0225	51	3221-0077	147	3336-0424	85	3619-0708	106
3205-0226	51	3221-0078	147	3336-0429	85	3619-0716	106
3205-0230	51	3221-0079	147	3336-0434	85	3619-0721	106
3205-0231	51	3221-0080	147	3336-0444	85	3619-0745	106
3205-0235	51	3221-0081	147	3336-0457	85	3619-0760	106
3205-0236	51	3221-0082	147	3336-0459	85	3619-0761	106
3205-0240	51	3221-0083	147	3336-1890	85	3619-0762	106
3205-0241	51	3221-0084	147	3336-1891	85	3619-0763	106
3205-0401	52	3221-0085	147	3336-1897	85	3619-0764	106
3205-0402	52	3221-0086	147	3602-0002	159	3619-0765	106
3205-0403	52	3221-0087	147	3602-0004	159	3619-0766	106
3205-0404	52	3221-0088	147	3602-1051	159	3619-0786	106
3205-0405	52	3221-0089	147	3602-1052	159	3619-0787	106
3205-0406	52	3221-0090	147	3602-1055	159	3619-0788	106
3205-0407	52	3221-0095	147	3602-1057	159	3619-0789	106
3205-0408	52	3221-0410	146	3602-1059	159	3619-0790	106
3205-0409	52	3221-0411	146	3602-1060	159	3619-0791	106
3205-0503	52	3221-0412	146	3602-1061	159	3619-0792	106
3205-0504	52	3221-0413	146	3602-1062	159	3619-0809	107
3205-0505	52	3221-0414	146	3602-1065	159	3619-0810	107
3205-0506	52	3221-0415	146	3604-0034	155	3619-0811	107
3205-0507	52	3221-0416	146	3604-0035	155	3619-3530	107
3205-5040	51	3221-0417	146	3604-0036	155	3619-3531	107
3206-3968	54	3221-0418	146	3604-0071	155	3624-0001	150
3207-0290	67	3221-0419	146	3605-0650	158	3624-0002	150
3207-0291	67	3221-0420	146	3605-0652	158	3624-0003	150
3207-0292	67	3221-0421	146	3605-0655	158	3624-0144	69
3207-0294	67	3221-0422	146	3605-0664	158	3624-1007	151
3207-0296	67	3221-0423	146	3605-0665	158	3624-1008	151
3213-0401	157	3221-0424	146	3605-0668	158	3624-1009	151
3213-0413	157	3221-0425	146	3605-0669	158	3658-1965	95
3213-0415	157	3221-0426	146	3605-0671	158	3658-1969	95
3213-0416	157	3222-0083	53	3605-0672	158	3658-1973	95
3213-0451	157	3222-0084	53	3605-0676	158	3658-1977	95
3213-0501	157	3222-0085	53	3605-0677	158	3658-1981	95
3213-0543	157	3222-0143	53	3605-0678	158	3658-1985	95
3213-0544	157	3222-0144	53	3605-0679	158	3670-0655	115
3213-0545	157	3222-0145	53	3605-0681	158	3670-0656	115
3213-0551	157	3222-0183	53	3605-0736	158	3670-0657	115
3217-0584	156	3222-0184	53	3605-0737	158	3670-0660	115
3217-0585	156	3222-0185	53	3605-0738	158	3670-0665	115
3217-0586	156	3222-0233	53	3605-0901	158	3670-0670	115
3217-0587	156	3222-0234	53	3618-0011	109	3670-0675	115
3217-0588	156	3222-0235	53	3618-0021	109	3670-0679	115
3219-2902	48	3222-0283	53	3618-0031	109	3670-0680	115
3219-2904	48	3222-0284	53	3618-0041	109	3670-0701	115
3219-2906	48	3222-0285	53	3618-0051	109	4040-4101	99
3219-2908	48	3222-0333	53	3618-0052	109	4040-4104	99
3219-2910	48	3222-0334	53	3618-0201	109	4040-4107	99
3219-2912	48	3222-0335	53	3618-0205	109	4040-4110	99
3219-2914	48	3232-1001	45	3618-0215	109	4040-4112	99

## Index of Industrial Hose by Product Number

Number	Page	Number	Page	Number	Page	Number	Page
4040-4113	99	4175-0861	86	4465-1362	37	4663-4001	46
4110-0009	134	4175-0863	86	4465-1371	37	4663-4002	46
4110-0010	134	4175-0865	86	4465-1372	37	4663-4003	46
4110-0016	128	4175-0867	86	4465-1381	37	4663-4004	46
4110-0017	128	4175-0869	86	4465-1382	37	4663-4005	46
4110-0400	121	4175-0871	86	4465-1701	36	4663-4006	46
4110-0500	121	4175-0872	86	4465-1702	36	4663-4007	46
4110-0701	128	4175-0873	86	4465-1704	36	4663-4008	46
4110-0704	128	4175-0874	86	4465-1705	36	4663-4009	46
4110-0707	128	4175-0875	86	4465-1706	36	4663-4010	46
4110-0710	128	4175-0876	86	4657-2156	153	4663-4011	46
4110-0713	128	4175-0877	86	4657-2225	153	4663-4012	46
4110-0715	131	4175-0878	86	4657-2400	153	4663-4013	46
4110-0716	131	4175-0879	86	4657-2401	152	4663-4014	46
4110-0717	131	4175-0880	86	4657-2402	152	4663-4015	46
4110-1101	131	4175-0883	86	4657-2403	152	4663-4016	46
4110-1102	131	4175-0886	86	4657-2404	152	4663-4017	46
4110-1107	131	4175-0889	86	4657-2405	153	4663-4018	46
4110-1108	131	4176-0856	87	4657-2406	154	4663-4019	46
4110-1109	129	4176-0857	87	4657-2407	154	4663-4020	46
4110-1110	129	4176-0859	87	4657-2408	152	4663-4021	46
4129-0085	104	4176-0861	87	4657-2409	154	4663-4022	46
4129-0086	104	4176-0863	87	4657-2410	154	4663-4023	46
4129-0100	104	4176-0865	87	4657-2412	152	4684-1540	94
4129-0105	104	4176-0867	87	4657-2413	152	4684-1545	94
4129-0150	104	4176-0869	87	4657-2414	152	4684-1551	94
4129-0200	104	4176-0871	87	4657-2415	152	4684-1556	94
4129-0256	104	4176-0872	87	4657-2416	152	4684-1561	94
4169-0210	88	4176-0874	87	4657-2417	152	4684-1601	94
4169-0220	88	4176-0875	87	4657-2418	153	4684-1611	94
4169-0224	88	4176-0876	87	4657-2419	153	4684-1651	94
4169-0240	88	4176-0877	87	4657-2420	153	4684-1660	94
4169-0246	88	4176-0878	87	4657-2421	153	4684-1670	94
4169-0260	88	4176-0879	87	4657-2422	153	4684-1680	94
4169-0270	88	4176-0880	87	4657-2423	153	4684-1690	94
4169-0280	88	4176-0883	87	4657-2424	153	4684-1700	94
4169-0288	88	4176-0886	87	4657-2425	154	4684-1706	94
4169-0300	88	4217-0310	68	4657-2426	154	4684-1707	94
4169-0320	88	4217-0311	68	4657-2427	154	4684-1708	94
4169-0340	88	4218-0004	44	4657-2428	154	4684-1709	94
4169-0345	88	4218-0009	44	4657-2429	154	4684-1711	94
4169-0360	88	4218-0010	44	4657-2430	154	4684-1720	94
4169-0362	88	4218-1002	44	4657-2431	154	4684-1722	94
4169-0376	88	4219-0093	97	4657-2499	153	4684-1730	94
4169-0383	88	4219-0097	97	4657-2562	153	4684-1740	94
4169-0402	88	4219-0102	97	4657-2652	152	4684-1750	94
4169-0420	88	4219-0103	97	4663-1516	47	4684-1760	94
4169-0425	88	4219-0104	97	4663-1518	47	4684-1764	94
4169-0433	88	4219-0107	97	4663-1530	47	4684-1766	94
4169-0484	88	4219-0109	97	4663-1540	47	4685-2016	89
4169-0491	88	4219-0116	97	4663-1543	47	4685-2018	89
4171-0195	90	4219-4120	96	4663-1548	47	4685-2020	89
4171-0197	90	4219-4125	96	4663-1550	47	4685-2022	89
4171-0204	90	4219-4140	96	4663-1556	47	4685-2024	89
4171-0206	90	4219-4145	96	4663-1560	47	4685-2026	89
4171-0210	90	4219-4146	96	4663-1565	47	4685-2028	89
4171-0213	90	4219-4380	96	4663-1569	47	4685-2030	89
4171-0217	90	4219-4385	96	4663-1570	47	4685-2032	89
4171-0223	90	4219-4560	96	4663-1575	47	4685-2034	89
4171-0224	90	4219-4565	96	4663-1580	47	4685-2036	89
4171-0229	90	4219-4567	96	4663-1589	47	4685-2038	89
4171-0234	90	4219-4580	96	4663-1595	47	4685-2040	89
4171-0238	90	4219-4585	96	4663-1599	47	4685-2042	89
4171-0241	90	4219-5520	83	4663-1615	47	4685-2044	89
4171-0246	90	4219-5521	83	4663-1616	47	4685-2046	89
4171-0249	90	4219-5522	83	4663-2828	98	4685-2048	89
4171-0260	90	4219-5523	83	4663-2830	98	4685-2056	89
4171-0265	90	4219-5524	83	4663-2929	98	4685-2064	89
4171-0270	90	4219-5524	83	4663-2930	98	4685-2080	89
4171-0270	90	4219-5651	84	4663-2932	98	4685-2096	89
4171-0275	90	4219-5652	84	4663-2933	98	4686-0028	113
4171-0280	90	4219-5653	84	4663-3321	47	4686-0029	113
4171-0285	90	4219-5654	84	4663-3454	47	4686-0030	113
4171-0290	90	4230-0060	91	4663-3456	47	4686-0066	113
4171-0295	90	4230-0129	91	4663-3461	47	4686-0067	113
4171-0835	90	4230-0134	91	4663-3624	98	4686-0068	39
4175-0855	86	4230-0135	91	4663-3625	98	4686-0069	39
4175-0856	86	4230-0150	91	4663-3954	47	4686-0070	39
4175-0857	86	4230-0193	91	4663-3976	98	4686-0071	39
4175-0859	86	4465-1361	37	4663-4000	46		

## Index of Industrial Hose by Product Number

Number	Page	Number	Page	Number	Page	Number	Page
4686-0072	39	4688-0653	122	4688-2017	136	4695-0004	62
4686-0073	39	4688-0656	122	4688-2018	136	4695-0005	62
4686-0074	161	4688-0660	122	4688-2024	132	4695-0006	62
4686-0075	161	4688-0665	122	4688-2025	132	4695-0007	62
4686-0199	161	4688-0668	122	4688-2026	132	4695-0008	62
4686-0200	161	4688-0675	122	4688-2031	138	4695-0055	62
4686-0201	161	4688-0680	122	4688-2033	138	4695-0211	62
4686-0202	161	4688-0690	122	4688-2040	139	4695-0216	62
4686-0203	161	4688-0697	122	4688-2041	139	4695-0229	62
4686-0204	161	4688-0698	122	4688-2042	139	4695-0607	63
4686-0205	161	4688-0702	122	4688-2043	139	4695-0608	63
4686-0206	161	4688-1305	137	4688-2044	139	4695-0609	63
4686-0207	161	4688-1306	137	4688-2045	139	4695-0610	63
4686-0208	161	4688-1307	137	4688-2047	132	4695-0628	62
4686-0209	161	4688-1308	137	4688-2048	132	4695-0670	62
4686-0210	161	4688-1309	137	4688-2104	124	4695-0698	62
4686-0211	161	4688-1310	137	4688-2105	124	4695-0699	62
4686-0212	161	4688-1311	137	4688-2107	124	4695-0700	62
4686-0213	161	4688-1320	140	4688-2108	124	4695-0701	62
4686-0214	161	4688-1321	140	4688-2109	124	4695-0720	62
4686-0234	161	4688-1322	140	4688-2164	124	4695-0729	62
4686-0235	161	4688-1342	137	4688-2165	124	4695-0737	62
4686-0236	161	4688-1343	137	4688-2178	122	4695-0738	62
4686-0237	161	4688-1344	137	4688-2222	133	4695-0774	62
4686-0250	161	4688-1351	137	4688-2223	133	4695-0933	112
4686-0602	93	4688-1352	137	4689-0001	125	4695-0934	112
4686-0604	93	4688-1353	137	4689-0002	125	4695-0935	112
4686-0606	93	4688-1355	137	4689-0005	125	4695-0936	112
4686-0608	93	4688-1362	137	4689-0006	125	4696-0001	66
4686-0610	93	4688-1465	137	4689-0007	125	4696-0002	66
4686-0612	93	4688-1491	140	4691-0017	119	4696-0003	66
4686-0614	93	4688-1493	137	4691-0018	119	4696-0004	66
4686-0616	93	4688-1496	122	4691-0039	119	4696-0005	66
4686-0618	93	4688-1497	122	4691-0040	119	4696-0006	66
4686-0620	93	4688-1498	122	4691-0305	101	4696-0007	65
4686-0622	93	4688-1511	137	4691-0306	101	4696-0008	65
4686-0624	93	4688-1530	140	4691-0320	101	4696-0009	66
4686-0626	93	4688-1531	140	4691-0325	101	4696-0012	66
4686-0628	93	4688-1612	137	4691-0340	101	4696-0013	66
4686-0630	93	4688-1613	122	4691-0346	101	4696-0014	65
4686-0632	93	4688-1700	135	4691-0349	101	4696-0015	65
4686-0638	93	4688-1701	135	4691-0355	101	4696-0016	65
4686-0640	93	4688-1702	135	4691-0360	101	4696-0017	66
4686-0642	93	4688-1703	135	4691-0370	101	4696-0023	65
4686-0643	93	4688-1704	135	4691-0400	103	4696-0024	65
4686-0645	93	4688-1705	135	4691-0405	103	4696-0025	65
4686-0646	93	4688-1706	135	4691-0410	103	4696-0203	66
4686-0656	93	4688-1707	135	4691-0420	103	4697-0014	64
4686-0657	93	4688-1708	135	4691-0430	103	4697-0015	64
4686-0701	160	4688-1709	135	4691-0435	103	4697-0016	64
4686-0702	160	4688-1710	135	4691-0440	103	4697-0017	64
4686-0703	160	4688-1711	135	4691-0450	103	4697-0018	64
4686-0704	160	4688-1712	135	4691-0455	103	4697-0019	64
4686-0705	160	4688-1713	135	4691-0501	102	4697-0020	64
4686-0706	160	4688-1718	135	4691-0502	102	4697-0021	64
4686-0707	160	4688-1719	135	4691-0503	102	4697-0022	64
4686-0708	160	4688-1720	135	4691-0504	102	4697-0057	64
4686-0709	160	4688-1721	135	4691-0505	102	4697-0058	64
4686-0710	160	4688-1722	135	4691-0506	102	4697-0059	64
4686-0711	160	4688-1723	135	4691-0507	102	4698-0001	61
4686-0712	160	4688-1724	135	4691-0508	102	4698-0002	61
4686-0751	162	4688-1725	135	4691-0700	111	4698-0003	61
4686-0752	162	4688-1726	135	4691-0701	111	4698-0004	61
4686-0753	162	4688-1727	135	4691-0702	111	4698-0011	60
4687-0200	141	4688-1728	135	4691-0703	111	4698-0012	60
4687-0251	141	4688-1729	135	4691-0704	111	4698-0013	60
4687-0252	141	4688-1730	135	4691-4342	101	4698-0014	60
4687-0253	141	4688-1731	135	4693-0001	76	4698-0015	60
4688-0454	137	4688-1732	138	4693-0205	76	4698-0016	60
4688-0455	137	4688-1733	138	4693-0210	76	4698-0017	60
4688-0584	127	4688-1734	138	4693-0220	76	4698-0021	60
4688-0585	127	4688-1735	138	4693-0225	76	4698-0022	60
4688-0587	127	4688-1761	123	4693-0235	76	4698-0023	60
4688-0588	127	4688-1762	123	4693-0251	76	4698-0024	60
4688-0589	127	4688-1763	123	4693-0260	76	4698-0025	60
4688-0590	130	4688-2011	136	4693-0262	76	4698-0026	60
4688-0591	130	4688-2012	136	4695-0001	62	4698-0027	60
4688-0592	130	4688-2015	136	4695-0002	62	4698-0029	60
4688-0651	122	4688-2016	136	4695-0003	62	4698-0031	60

## Index of Industrial Hose by Product Number

Number	Page	Number	Page	Number	Page	Number	Page
4698-0072	.61	7107-00455	.175	7422-1070	.170	7744-2108	.42
4698-0073	.61	7107-00465	.175	7422-1071	.170	7744-2109	.42
4698-0104	.60	7107-00475	.175	7422-1072	.170	7744-4101	.80
7107-0010	.171	7107-00485	.173	7422-1073	.170	7744-4102	.80
7107-0011	.171	7107-00495	.173	7422-1074	.170	7744-4103	.80
7107-0013	.171	7107-0500	.179	7422-1075	.170	7744-4104	.80
7107-0014	.171	7107-0501	.179	7422-1076	.170	7744-4105	.80
7107-0016	.171	7107-00505	.173	7422-1077	.170	7744-4106	.80
7107-0017	.171	7107-00515	.173	7422-1078	.170	7744-4107	.80
7107-0019	.171	7107-00525	.172	7422-1079	.170	7744-4301	.81
7107-0021	.171	7107-00535	.172	7422-1080	.170	7744-4302	.81
7107-0022	.171	7107-00545	.172	7422-1081	.170	7744-4303	.81
7107-0025	.171	7107-00555	.172	7422-1082	.170	7744-4304	.81
7107-0026	.171	7107-00565	.174	7422-1083	.170	7744-4305	.81
7107-0027	.177	7107-00575	.174	7422-1084	.170	7744-4306	.81
7107-0028	.177	7107-00585	.174	7422-1085	.170	7744-4307	.81
7107-0029	.177	7107-00595	.174	7422-1086	.170	7744-4420	.82
7107-0030	.177	7107-00605	.174	7422-1087	.170	7744-4425	.82
7107-0031	.177	7107-00615	.174	7744-0000	.42	7744-4430	.82
7107-0032	.177	7107-00785	.171	7744-0008	.42	7744-4440	.82
7107-0033	.177	7207-0597	.179	7744-0009	.42	7744-4501	.79
7107-0034	.176	7207-0598	.179	7744-0011	.42	7744-4502	.79
7107-0035	.176	7207-0599	.179	7744-0012	.42	7744-4503	.79
7107-0036	.176	7253-01905	.178	7744-0013	.42	7744-4504	.79
7107-0037	.176	7253-01915	.178	7744-0014	.42	7744-4505	.79
7107-0038	.176	7266-0733	.148	7744-0015	.42	7744-4506	.79
7107-0039	.176	7266-0734	.148	7744-1001	.167	7744-4507	.79
7107-0040	.176	7266-0735	.148	7744-1002	.167	7744-4508	.79
7107-0041	.175	7266-07335	.148	7744-1003	.167	7744-4509	.79
7107-0042	.175	7266-07345	.148	7744-1004	.167	7744-5201	.41
7107-0043	.175	7266-07355	.148	7744-1005	.167	7744-5202	.41
7107-0044	.175	7341-02675	.178	7744-1006	.167	7744-5203	.41
7107-0045	.175	7341-02685	.178	7744-1007	.167	7744-5204	.41
7107-0046	.175	7341-02695	.178	7744-1500	.40	7744-5205	.41
7107-0047	.175	7341-20185	.178	7744-1501	.40	7744-5206	.41
7107-0048	.173	7341-20315	.178	7744-1502	.40	7744-5207	.41
7107-0049	.173	7341-20325	.178	7744-1503	.40	7744-5208	.41
7107-0050	.173	7341-20335	.178	7744-1504	.166	7744-6102	.105
7107-0051	.173	7341-20365	.178	7744-1505	.166	7744-6103	.105
7107-0052	.172	7341-20375	.178	7744-1506	.166	7744-6104	.105
7107-0053	.172	7341-20385	.178	7744-1507	.166	7744-6105	.105
7107-0054	.172	7341-20395	.178	7744-1508	.166	7744-6106	.105
7107-0055	.172	7408-1008	.169	7744-1509	.166	7744-6107	.105
7107-0056	.174	7408-1010	.169	7744-1510	.166	7744-6108	.105
7107-0057	.174	7408-1012	.169	7744-1511	.166	7744-6209	.105
7107-0058	.174	7408-1016	.169	7744-1512	.78	7744-7015	.144
7107-0059	.174	7408-1020	.169	7744-1513	.78	7744-7020	.144
7107-0060	.174	7408-1024	.169	7744-1514	.78	7744-7030	.144
7107-0061	.174	7408-1028	.169	7744-1515	.78	7744-7040	.144
7107-0078	.171	7408-1032	.169	7744-1516	.78	7744-7050	.144
7107-00105	.171	7408-1036	.169	7744-1517	.78	7744-7060	.144
7107-00115	.171	7408-1048	.169	7744-1518	.78	7744-7103	.142
7107-00135	.171	7408-1052	.169	7744-1519	.78	7744-7104	.142
7107-00145	.171	7408-1056	.169	7744-1520	.78	7744-8030	.145
7107-00165	.171	7408-1060	.169	7744-1521	.78	7744-8040	.145
7107-00175	.171	7408-1064	.169	7744-1522	.78	7744-8103	.143
7107-00195	.171	7408-1072	.169	7744-1523	.78	7744-8104	.143
7107-00215	.171	7408-1104	.169	7744-1524	.78		
7107-00225	.171	7422-1049	.170	7744-1525	.78		
7107-00255	.171	7422-1050	.170	7744-1526	.78		
7107-00265	.171	7422-1051	.170	7744-1527	.78		
7107-00275	.177	7422-1052	.170	7744-1528	.78		
7107-00285	.177	7422-1053	.170	7744-1529	.78		
7107-00295	.177	7422-1054	.170	7744-1530	.78		
7107-00305	.177	7422-1055	.170	7744-1531	.78		
7107-00315	.177	7422-1056	.170	7744-1532	.78		
7107-00325	.177	7422-1057	.170	7744-1538	.168		
7107-00335	.177	7422-1058	.170	7744-1539	.168		
7107-00345	.176	7422-1059	.170	7744-1540	.168		
7107-00355	.176	7422-1060	.170	7744-1541	.168		
7107-00365	.176	7422-1061	.170	7744-1542	.168		
7107-00375	.176	7422-1062	.170	7744-1543	.168		
7107-00385	.176	7422-1063	.170	7744-2101	.42		
7107-00395	.176	7422-1064	.170	7744-2102	.42		
7107-00405	.176	7422-1065	.170	7744-2103	.42		
7107-00415	.175	7422-1066	.170	7744-2104	.42		
7107-00425	.175	7422-1067	.170	7744-2105	.42		
7107-00435	.175	7422-1068	.170	7744-2106	.42		
7107-00445	.175	7422-1069	.170	7744-2107	.42		

# Packaging Code Reference

CODE	DESCRIPTION	+/- FEET	MIN LENGTH (FT)	MAX PIECES	INCREMENT (FT)
A	Qty ± 20%, Min Length: 10 ft, Max Pieces: 3, 50% in Lengths 40 ft & longer, 2 lengths under 20 ft allowed.	20%	10	3	*
B	Qty ± 10 ft, Min Length: 5 ft, Max Pieces: 2	10	5	2	*
C	Qty ± 10%, Min Length: 10 ft, 50% in lengths 40 ft & longer, 50% in lengths: 10 ft to 39 ft	10%	10	*	*
D	Qty ± 10%, Min Length: 10 ft, Max Pieces: 6, 65% in lengths longer than 45 ft, 2 Pieces under 20 ft allowed	10%	10	6	*
E	Qty ± 0 ft, Min Length: 10 ft, Max Pieces: 4	0	10	4	*
F	Qty ± 0 ft, Min Length: 10 ft, Max Pieces: 3	0	10	3	*
G	Packaged in 270ft to 330ft reels. Maximum of 3 pieces. Minimum length 25ft.	*	*	*	*
I	Qty ± 20 ft, Min Length: 20 ft, Max Pieces: 3, one Length 40 ft or longer	20	20	3	*
J	a. Hose 3/4" I.D. & Below: Footage Tolerance: 450 ft-650 ft, Min Pieces: 1 per reel, Max Pieces: 4 per reel, 1 piece allowed under 100 ft, Min Length: 15 ft	200	15	4	*
J	b. Hose 1" I.D. & Above: Footage Tolerance: 200 ft - 350 ft Min Pieces: 1 per reel, Max Pieces: 3 per reel, 1 piece allowed under 100 ft, Min Length: 15 ft [unless otherwise specified in additional special instructions]	150	15	3	*
K	Qty ± 20%, Min Length: 5 ft, Max Pieces: 4, 65% in lengths longer than 45 ft, 25% in lengths 25 ft to 45 ft, 10% in lengths 5 ft to 25 ft	20%	5	4	*
L	Qty ± 10%, Min Length: 25 ft, Max Pieces: 3	10%	25	3	*
M	Qty ± 20%, Min Length: 50 ft, Max Pieces: 2	20%	50	2	*
N	Qty ± 0%, Min Length: 10 ft, Max Pieces: 2	0%	10	2	*
O	Each Length must be 1 Continuous Piece. Acceptable Footage Tolerance: 121 ft - 203 ft	*	*	1	*
Q	Qty ± 10%, Max Pieces: 1 continuous length	10%	*	1	*
R	Hose lengths shall be as long as possible, Min Length: 25 ft Hose will be stacked on pallets in bales, stretch wrapped and banded	*	25	*	*
S	Qty ± 0 ft, Min Length: 50 ft, Increments: 50 ft	0	50	*	50
T	One Continuous Length Piece	*	*	1	*
U	Qty ± 10%, Min Length: 15 ft, Max Pieces: 3	10%	15	3	*
V	Qty ± 0 ft, Min Length: 10 ft, Max Pieces: 6, 65% in lengths longer than 45 ft, 2 lengths under 20 ft allowed	0	10	6	*
Y	Qty ± 0 ft, Min Length: 10 ft, Max Pieces: 10, Max Pieces under 25 ft: 6	0	10	10	*
Z	Qty ± 0 ft, Min Length: 12 ft, Max Pieces: 5.	0	12	5	*
AA	Qty ± 200 ft, Max Pieces: 4, 1 length 25 ft to 50 ft. Max Pieces under 100 ft: 2	200	*	4	*
BB	Qty ± 125 ft, Min Length: 50 ft, Max Pieces: 3	125	50	3	*
CC	Qty ± 100 ft, Min Length: 15 ft, Max Pieces: 5	100	15	5	*
DD	Qty ± 100 ft, Max Pieces: 5, 1 piece 25 ft to 49 ft. All other pieces over 49 ft	100	*	5	*
EE	Qty ± 100 ft, Min Length: 50 ft, Max Pieces: 4, 1 length 25 ft to 50 ft. Max Pieces: 2, under 100 ft.	100	50	4	*
FF	Qty ± 100 ft, Min Length: 25 ft, Max Pieces: 4	100	25	4	*
GG	Qty ± 100 ft, Min Length: 15 ft, Max Pieces: 4, 1 piece allowed under 100 ft	100	15	4	*
HH	Qty ± 100 ft, Max Pieces: 2 Pieces, Increments: 50 ft	100	*	2	50
II	Qty ± 50 ft, Min Length: 50 ft, Max Pieces: 3, Increments: 25 ft	50	50	3	25

# Packaging Code Reference

CODE	DESCRIPTION	+/- FEET	MIN LENGTH (FT)	MAX PIECES	INCREMENT (FT)
JJ	Qty ± 50 ft, Min Length: 50 ft, Max Pieces: 3	50	50	3	*
KK	Qty ± 50 ft, Min Length: 50 ft, Max Pieces: 3, One length 25 ft to 50 ft. Max Pieces: 2, under 100 ft.	50	50	3	*
LL	Qty ± 50 ft, Min Length: 25 ft, Max Pieces: 3, 1 length under 100 ft.	50	25	3	*
MM	Qty ± 50 ft, Max Pieces: 2, Increments: 50 ft	50	*	2	50
NN	Qty ± 40 ft	40	*	*	*
OO	Qty ± 30 ft, Min Length: 25 ft, Max Pieces: 3	30	25	3	*
PP	Qty ± 20 ft, Min Length: 25 ft, Max Pieces: 3	20	25	3	*
QQ	Qty ± 10 ft, Min Length: 10 ft, Max Pieces: 2	10	10	2	*
RR	Qty ± 0 ft, Min Length: 25 ft, Max Pieces: 15, Max Pieces at 25 ft: 3	0	25	15	*
SS	Qty ± 0 ft, Min Length: 25 ft, Max Pieces: 10, Increments: 25 ft	0	25	10	25
TT	Qty ± 0 ft, Min Length: 30 ft, Max Pieces: 4	0	30	4	*
UU	Qty ± 0 ft, Max Pieces: 3, Increments: 50 ft	0	*	3	50
VV	Qty ± 0 ft, Min Length: 50 ft, Max Pieces: 3	0	50	3	*
WW	Qty ± 0 ft, Min Length: 15 ft, Max Pieces: 3	0	15	3	*
XX	Qty ± 0 ft, Max Pieces: 2, Increments: 50 ft	0	*	2	50
YY	Qty ± 0 ft, Min Length: 25 ft, Max Pieces: 2	0	25	2	*
					* = N/A

Gates reserves the right to change packaging specs at any time without notice.

## STANDARD PACK DETAILS

REEL	Reel
ASSY	Assembly
CTN	Carton
PLT	Pallet
BALE	Bale
CRT	Crate
UPS	UPS Ground Shippable
STRT	Straight
BULK	Bulk













# What's New

Gates is excited to announce the revolutionary **Efficiency Engineered** new naming system for industrial hose. All of the products in this catalog will start using the new descriptive and intuitive names. But don't worry, the previous names will be included on catalog pages and product labels for reference during the transition.

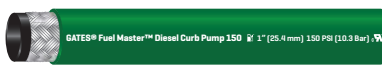
			PAGE
		<b>Ag Master™ 200/250</b> Black multi-purpose air, water and light chemical hoses for the agriculture market.	38
		<b>Ag Master™ Solution 150SD</b> Medium to light duty water suction/discharge for agricultural, construction, and industrial applications.	39
		<b>Ag Master™ XTreme™ PVC Solution (90-100) SD</b> Fabric reinforced PVC hose for the ag market.	40
		<b>Air Master™ Umbilical (1000-1125)</b> Air breathing hose for handling of mixtures of oxygen, helium, & nitrogen gases used in underwater diving.	43
		<b>Air Master™ SCUBA 500</b> Scuba hose for connecting the regulator to the mask.	44
		<b>Air Master™ Respirator 500</b> Respirator hose for applications such as firefighting, barrier suits and mining.	45
		<b>Black Gold® Bulk Material 300D/300SD</b> Heavy-duty ABS type approved transfer hoses for offshore and land rigs.	119
		<b>Black Gold® Drill Water 300D/300SD</b> Heavy-duty ABS type approved transfer hoses for offshore and land rigs.	113/ 114
		<b>Black Gold® Mud &amp; Oil 300D/300SD</b> Heavy-duty ABS type approved transfer hoses for offshore and land rigs.	125/ 126
		<b>Black Gold® Oilfield Frac 400D/400SD</b> Oilfield frac hose with abrasion resistant cover.	133/ 134
		<b>Black Gold® Oilfield Service 100/150SD</b> Heavy-duty 8" rugged hose primarily intended for frac tank connections.	132
		<b>Black Gold® Oilfield Service 400D/400SD UltraBriasion</b> Oilfield frac hose with abrasion resistant cover including a yellow wear indicator cover.	129
		<b>Black Gold® Potable Water 300D/300SD</b> Heavy-duty ABS type approved transfer hoses for offshore and land rigs.	118
		<b>Black Gold® PowerSpiral 5000</b> Extremely flexible API 7K hose for drilling applications See <i>Gates Oilfield Catalog</i>	

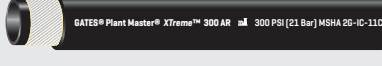







# What's New

			PAGE
		<b>Black Gold® Chemical Plus XLPE 250SD</b> New heavy-duty ABS type approved transfer hoses for offshore and land rigs.	112
		<b>Chem Master™ Plus CPE (150-200) SD MegaFlex®</b> New lightweight & flexible, easy-to-handle, high temperature CPE chemical transfer hose resistant to over 400 chemicals.	65
		<b>Food Master™ Oils &amp; Dairy 150SD MegaFlex®</b> Extremely flexible food and beverage hose.	75
		<b>Food Master™ PVC Clear Tubing</b> Light duty laboratory, water and air tubing.	79
		<b>Fuel Master™ Diesel Curb Pump 150</b> Extra abrasion resistance. Maximizes hose life in severe abrasion environments.	151
		<b>Plant Master® XTreme™ 300 AR (Black)</b> Extra abrasion resistance. Maximizes hose life in severe abrasion environments.	52
		<b>Water Master® PVC</b> For heavy duty suction & discharge service.	166
		<b>Water Master® Plus PVC Layflat</b> For general discharge service.	168
	<b>GC® 96 TSi™ CRIMPER</b> An ergonomical 6" industrial hose and 2½" hydraulic hose crimper with electronic touch screen control.	34	

# Efficiency. Engineered.

## GATES INDUSTRIAL HOSE > EFFICIENCY. ENGINEERED.

There's more to our new system than just names. We've also created icons for each major category, and a color to match. New, bigger, bolder color-coded laylines identify the industry or application.

- |   |   |                      |   |  |                           |
|---|---|----------------------|---|--|---------------------------|
|    |    | <b>Ag Master</b>     |  |   | <b>Mine Master</b>        |
|    |    | <b>Air Master</b>    |  |   | <b>Black Gold</b>         |
|    |    | <b>Plant Master</b>  |  |   | <b>Fuel Master</b>        |
|    |    | <b>Chem Master</b>   |  |   | <b>Clean Master</b>       |
|    |    | <b>Food Master</b>   |  |   | <b>Plant Master Steam</b> |
|    |   | <b>Marine Master</b> |  |  | <b>Water Master</b>       |
|  |  | <b>Bulk Master</b>   |   |  |                           |

No more guessing  
with a sensible  
naming system.



# Efficiency. Engineered.

## MORE THAN JUST NAMES

Most industrial hose naming systems spawn confusion, so relating them to products and applications becomes a difficult, time consuming chore. Plus, the risk of choosing the wrong hose for the job may compromise safety, performance, and the customer's trust.

We're making our industrial hose naming system more efficient and user-friendly. This running change uses descriptive and intuitive names. The easy-to-understand classification will:

- > Make it easy to find the right hose for the application
- > Reduce the learning curve for new employees
- > Help you better organize your hose inventory
- > Help eliminate downtime

## HOW THE SYSTEM WORKS

All our industrial hoses are now named "Master." The "Master" name is linked to an industry or application (ag, chem, mining, etc.), so you can tell instantly where the hose is meant to be used. The one exception is Black Gold® for the Oilfield Market - you can't change a classic.

We're also standardizing the way we describe our hoses:

**Standard, Plus** and **XTreme™**. These three levels represent increasing degrees of performance, such as resistance to oil, abrasion or chemicals.

## NEW HOSE IDENTIFICATION SYSTEM

Brand Name	Performance Level	Pressure Rating	Premium Performance Feature		
Correlates to the industry or application	<ul style="list-style-type: none"> <li>&gt; Standard</li> <li>&gt; Plus</li> <li>&gt; XTreme™</li> </ul>	Working pressure (psi) <ul style="list-style-type: none"> <li>&gt; <b>D</b> Discharge</li> <li>&gt; <b>SD</b> Suction Discharge</li> </ul>	<ul style="list-style-type: none"> <li>&gt; <b>AR</b> Abrasion Resistant</li> <li>&gt; <b>CR</b> Crush Resistant</li> <li>&gt; <b>FR</b> Flame Resistant</li> <li>&gt; <b>HT</b> High Temperature</li> </ul>	<ul style="list-style-type: none"> <li>&gt; <b>LT</b> Low Temperature</li> <li>&gt; <b>NC</b> Non Conductive</li> <li>&gt; <b>SF</b> Silicone Free</li> </ul>	<ul style="list-style-type: none"> <li>&gt; Braid</li> <li>&gt; Clear</li> <li>&gt; Barricade®</li> <li>&gt; MegaFlex®</li> </ul>

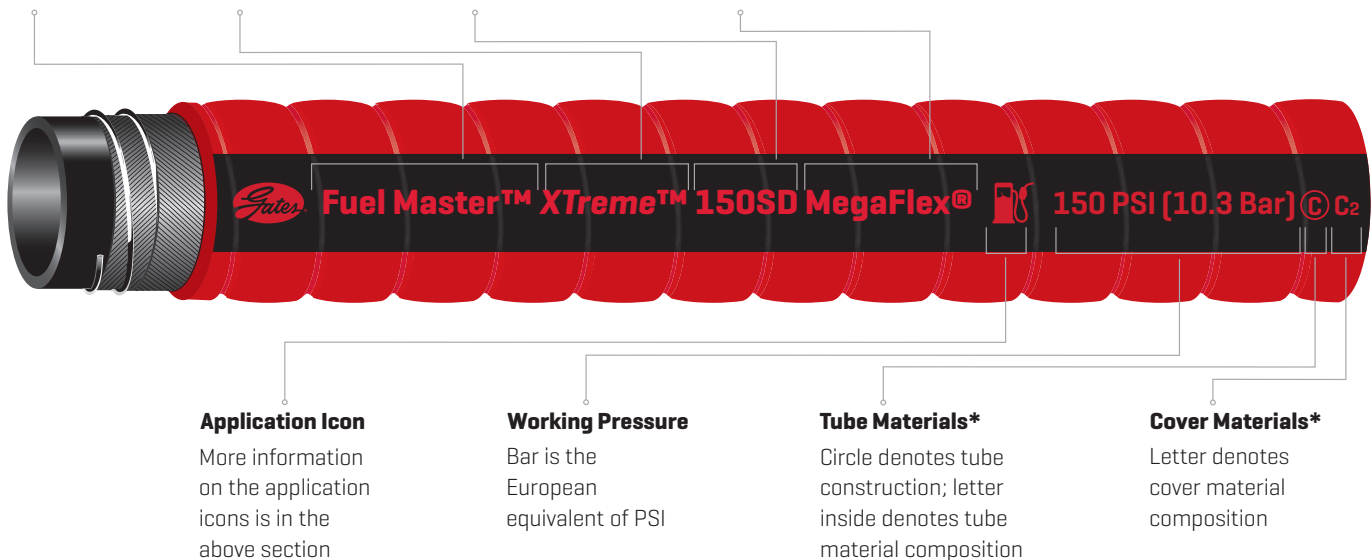

\* See following page for material codes.

# Gates Tube & Cover Material Codes

CODE	MATERIAL COMPOSITION
A	Polychloroprene (Chloroprene)
A2	Similar to Type A except it is white and is used primarily for edible products
B1 B2	Proprietary for special applications. Contact Denver Hose Product Application
C	Acrylonitrile Butadiene (Nitrile)
C2	A blend of Type C and plastic. (Modified Nitrile) Used primarily as hose cover material
C3	Modification to Nitrile tube
C4	Modification of Nitrile with excellent abrasion, tearing and gouging resistance (cover)
D	Natural Rubber (NR) and Styrene Butadiene (SBR)
D2	Similar to Type D, except it is white and compounded to handle food products
D3	Natural Rubber
G	PolyVinyl Chloride (PVC)
G1	Modified PVC
H	Isobutylene and Isoprene (Butyl)
J	Chlorinated Polyethylene (CPE)
K	Specially compounded Cross-Linked Polyethylene (Gatron™)
L	Ultra High Molecular Weight Polyethylene Ethylene (UHMWPE)
M	Chlorosulfonated Polyethylene (CSM)
MQ	Silicone Rubber
P	Ethylene, Propylene Diene (EPDM)
P2	Special for Steam Hose applications
S	Specially Compounded Thermoplastic Vulcanizate (Sanitron™)
T	Fluorinated Polyethylene (FEP)
U	Urethane
V	Fluorocarbon (FKM)
Z	Polyamide Resins (Nylon)

**NOTE:** Tube and cover compounds can differ between hoses. Compounds are designed for specific hose application requirements. Refer to the hose product sheet for recommended applications and restrictions. Example: Petroleum Transfer Hose Fuel Master 150SD (Type C Nitrile) has a different Nitrile tube compound than Marine Master Fuel Line (Type C Nitrile). Please read and observe all warnings on the back of the front cover of this catalog.

# Industrial Hose Name Finder

Former Hose Name	New Hose Name	Page	Former Hose Name	New Hose Name	Page
1000 MP/Mine Spray	Mine Master™ Spray 1000	106	Mustang Crush® Resistant	Chem Master™ Plus XLPE 200SD CR	63
18MB	Mine Master™ Air Drill 500	109	Ohmega®	Plant Master® 300 NC	59
19B, 119B	Plant Master® XTreme™ 325 Braid	48	Oilfield Service 100SD	Black Gold® Oilfield Service [100-150]SD	132
205MB Steam King®	Plant Master® Steam 250	158	Oilfield Service 400D	Black Gold® Oilfield Service 400D	131
232MB Steam Queen®	Plant Master® Steam Plus 250	159	Oilfield Service 400SD	Black Gold® Oilfield Service 400SD	130
33HB	Air Master™ Diving Umbilical 1000 / 1125	43	Oilfield Vacuum	Black Gold® Oilfield Vacuum [100-150]SD	123
429W	Bulk Master™ SandBlast [120-150]D	104	Petroleum Drop 150SD MegaFlex®	Fuel Master™ XTreme™ 150SD MegaFlex®	136
4684CF (Wet Exhaust)	Marine Master™ Plus Wet Exhaust [15-100]SD	94	Powerbraid® Plus	Black Gold® Slim Hole Rotary [1500-5000]	115
500 MP Air Drill	Mine Master™ Air Drill 500 FR	110	PowerClean® - 1 or 2 Wire Braid	Clean Master™ Pressure Wash 1 WB / 2 WB	152
609W	Bulk Master™ Dry Cement [20-40]D	100	Premo Flex®	Plant Master® XTreme™ [250-315]	51
610W	Food Master® Dry Goods [25-40]D	77	Premo Flex AR	Plant Master® XTreme™ 300 AR	52
63SB, 163SB	Air Duct [5-20]SD	46	Python® Plus	Plant Master® Plus 300 Lock-On	53
688SB	Bulk Master™ Plus [40-60]SD	101	Renegade™	Chem Master™ Plus UHMWPE [125-200]SD	64
690SB	Food Master® Dry Goods [50-150]SD	76	Rock Dust	Mine Master™ Rock Dust 100SD	111
770SB	Bulk Master™ [4-24]SD	103	Sani-Pure™	Food Master® Oils & Dairy 150D	74
77B	Chem Master™ Paint Spray [500-750]	67	Scorpion™	Mine Master™ Air Drill 600 HT	108
Adapta Flex™ [Ag]	Ag Master™ [200-250]	38	Sea Horse®	Black Gold® Fuel 300D	128
Adapta Flex [Plant]	Plant Master® [150-300]	55	Sea Horse® HW	Black Gold® Fuel 300SD	127
Aquarius®	Black Gold® Potable Water [150-300]D	118	Shark®	Water Master® [100-150]SD AR	160
Arctic Longhorn® Megaflex®	Fuel Master™ 150 SD LT MegaFlex®	139	Stallion®	Chem Master™ XTreme™ FEP [125-200]SD	60
Baraccuda [Ag]	Ag Master™ Solution 150SD	39	Stallion® Crush Resistant	Chem Master™ XTreme™ FEP 200SD CR	61
Barracuda® [Water]	Water Master® [100-150]SD	161	Steelhead®	Water Master® Slurry 150D AR	163
Blacksnake®	Fuel Master™ Curb Pump 150	150	Steer®	Fuel Master™ 150D	140
Blender Transfer	Black Gold® Blender Transfer 150D	121	Super-Vac®	Black Gold® Super-Vac [60-150]SD	122
Cellar Master®	Food Master® Beverage 250SD CR	71	Super-Vac® MegaFlex®	Black Gold® Super-Vac [100-200] SD MegaFlex	124
Cellar Master® Light	Food Master® Beverage 150SD CR	72	Terminator®	Plant Master® XTreme™ 501 AR	49
Colt®	Chem Master™ EPDM [125-150]SD	66	Thermo AG™ 600	Ag Master™ Spray 600	36
Creamery/Paper Mill Washdown	Clean Master™ Washdown	157	Thermo AG™ 800	Ag Master™ Spray 800	37
Cyclone™	Clean Master™ Washdown 1000	156	Tufflex® Food	Food Master® PVC Clear Tubing [75-250] Braid	79
Diesel Exhaust Fluid	Chem Master™ DEF Transfer 350	68	Wet Exhaust [Hardwall]	Marine Master™ Wet Exhaust 100SD	93
Dolphin®	Water Master® [90-150]D	165	Wet Exhaust [Softwall]	Marine Master™ Wet Exhaust 100D	92
Duro Flex®	Plant Master® Plus [200-300]	54			
Food & Beverage Master®	Food Master® XTreme™ 250SD CR	70			
Food Master® Lite	Food Master® Oils & Dairy 150SD	73			
Fuel Oil Delivery	Fuel Master™ Delivery 200	146			
Hot Air Blower	Bulk Master™ Hot Air Blower [40-130]SD HT	102			
Hydrocarbon Drain	Chem Master™ Hydrocarbon Drain 250	69			
LOL	Plant Master® XTreme™ 300 Lock-On Braid	50			
Longhorn®	Fuel Master™ 150SD	137			
Longhorn® AF	Fuel Master™ XTreme™ 150SD	135			
Longhorn® Megaflex®	Fuel Master™ 150 SD MegaFlex®	138			
Longwall Mine Emulsion	Mine Master™ Longwall Emulsion 1000	107			
LP350, LP350X	Fuel Master™ LP 350	148			
LPG Vapor	Fuel Master™ LPG Vapor 125	149			
Marlin™	Water Master® 150D AR	164			
Master-Flex™ 101CL	Ag Master™ PVC Solution [30-90]SD Clear	42			
Master-Flex™ 200CL	Food Master® PVC [50-100]SD Clear	80			
Master-Flex™ 201CR	Food Master® PVC [35-50]SD Clear	81			
Master-Flex™ 202SW	Food Master® PVC Dry Goods [35-40]SD Clear	82			
Master-Flex™ 300 EPDM	Ag Master™ PVC Solution [35-80]SD	41			
Master-Flex™ 400	Bulk Master™ PVC [25-40]SD AR	105			
Master-Flex™ 500	Water Master® PVC Layflat [45-75]D	167			
Master-Flex™ Fuel Delivery	Fuel Master™ PVC 65SD	142			
Master-Flex™ Vapor Recovery	Fuel Master™ PVC Vapor Recovery 5SD	144			
Maverick™	Fuel Master™ 100SD	141			
Mustang®	Chem Master™ Plus XLPE [150-200]SD	62			

# Nomenclature Performance Levels

Performance level descriptions as they pertain to XTreme™, Plus and Standard designations.

FAMILY	BRAND	PERFORMANCE RATING	XTREME™	PLUS	STANDARD
Chemical	Chem Master	Chemical Resistance	More than 1250 highly corrosive chemicals	More than 400 basic chemicals	Mild chemicals
Air and Multi-Purpose	Plant Master	Oil Resistance	High Oil Resistance [ARPM Class A]	Medium Oil Resistance [ARPM Class B]	Limited Oil Resistance [ARPM Class C]
Food & Beverage	Food Master	Product Range	Many types of food & beverage products	N/A	Specific food & beverage products
Material Handling	Bulk Master	Tube Thickness	1/4" tube	3/16" tube	1/8" tube
Oilfield	Black Gold	Choke & Kill	API 16C	N/A	Lloyds 1000/499
Petroleum	Fuel Master	Petroleum Resistance	Constant contact and alternative fuels	N/A	Transfer of petroleum products
Steam	Plant Master	Cover Design	N/A	Oil resistant and red non-marking cover	Standard black cover

# Cut Length Program

---

Gates Industrial Hose Cut Length Program offers distributors easy access to custom cut length hoses. Many of the large I.D. standard-stock industrial hose products are available including our most popular hose lines, as well as those that may not typically be stocked.

Never pass up an order for special lengths Industrial Hose with the Gates Cut Length Program.

## HOW IT WORKS...

1. Your customer has a special request for a specific length of cut hose.\*
2. Check the inventory list at [Gates.com/cutlength](http://Gates.com/cutlength) to be sure the hose is available for custom cut lengths.
3. Call Gates Customer Service with your order – 855-428-3727.
4. Expedited shipping is available.

The Gates Industrial Hose Cut Length Program lets you quickly bring a complete package of Gates industrial hose products and services to your customers to meet every need.

For more information contact your Gates Sales or Customer Service Representative.

\*Any length is available (in 5 foot increments) and there is no minimum length charge. Standard freight terms will apply. Pricing will include a 20% premium over customer's class net price.

Contact customer service for:

- › Product Availability
- › Pricing
- › Lead Time





# Gates Industrial Hose Programs



Unlock the power of Gates Industrial Hose with these special programs.

<b>ASSEMBLIES</b>	In addition to bulk hose, Gates has the ability to provide finished assemblies. Contact Gates Customer Service for more details.
<b>COLORS</b>	Many hoses are available in colors not published in the catalog. Contact Gates Customer Service for more details.
<b>CRIMPER PROGRAMS</b>	Different cost sharing programs are available to help grow your industrial hose business and offset some of the equipment purchase expense. Refer to the table of contents for details on Gates Industrial Hose Crimpers.
<b>CUT LENGTHS</b>	In addition to standard catalog lengths, Gates can provide hoses cut to specific lengths. Refer to the Gates Customer Service for the cut length inventory list.
<b>PRESSURE RATINGS</b>	Use the Industrial Hose Finder or Hydraulic Hose Catalog to select hoses that have satisfactory working pressure ratings. Hoses are available in sizes and pressure ratings not published in the catalog. Contact Gates Customer Service for more details.
<b>PRIVATE BRAND LABEL (PBL)</b>	Customized product labels are available. Minimum order quantities may apply. Contact Gates Customer Service for more details.
<b>REMNANTS</b>	Remnant lengths are sometimes available in popular sizes at a discount. Contact Gates Customer Service for pricing, order requirements and availability.
<b>TRAINING</b>	Gates offers in-depth Industrial Hose Training Workshops at the Customer Solution Center and onsite Safety Connections training. For more info visit <a href="http://gates.com/gatesu">gates.com/gatesu</a> .
<b>TRANSPORTATION POLICY</b>	Freight will be allowed on shipments of \$2500* and over, F.O.B. point of shipment, and shipped to any one location served by common carrier within the continental U.S., Hawaii or Alaska. On shipments to Hawaii or Alaska, shipment by sea service is considered common carrier.
<b>TRUCKLOAD PROGRAMS</b>	Gates offers customized truckload programs (Orders direct from the factory or distribution center). Minimum order quantities apply. Contact your Gates District Sales Manager for details.

## CUSTOMER SERVICE

855.428.3727  
[custserv@gates.com](mailto:custserv@gates.com)

## ENGINEERING & SERVICES

Ph. 361.289.4800  
 Fx. 361.299.6266  
[crp.sales@gates.com](mailto:crp.sales@gates.com)

## INDUSTRIAL SALES CONTACTS

[gates.com/where-to-buy](http://gates.com/where-to-buy)

## PRODUCT APPLICATION ENGINEERING

+1.303.744.5070  
[FPPAsupport@gates.com](mailto:FPPAsupport@gates.com)

\* Gates reserves the right to change.

# Gates Authorized E2E Distributors

---

Industrial hose applications become more demanding every day. New rubber compounds, higher working pressures and temperatures, stricter environmental and safety regulations – all make hose and coupling selection a challenge. The traditional industry practice of mixing and matching hoses and fittings from different manufacturers carries greater risk than ever. Poor quality or incorrectly fabricated hose assemblies cause equipment damage, lost productivity, personal injury, or worse.

## **GATES E2E (END-TO-END) ENGINEERED SYSTEM AND DISTRIBUTOR PARTNERSHIP**

To mitigate risk and improve the reliability of industrial hose products, Gates developed its E2E integrated system of hoses and fittings and a partnership with specially qualified fabricators. Gates E2E system includes highly engineered, application-specific industrial hoses, fittings designed to match, and precise assembly procedures with up-to-the-minute Gates crimp specifications.

Gates Authorized E2E Distributors are uniquely qualified to implement Gates E2E system. Their personnel have been trained and certified at the Gates Customer Solutions Center. In addition, they adhere to hose assembly guidelines established by NAHAD (The Association for Hose and Accessories Distribution).

## **TESTING AND CERTIFICATION**

To ensure crimp integrity and reliability, all assemblies are tested to the rated proof pressure of the hose and accompanied by test certificates. Additional hydrostatic testing or electrical conductivity testing may be carried out as required. Testing is done in accordance with ARPM (Association for Rubber Products Manufacturers) recommended methods.

## **WE'VE GOT YOU COVERED**

You can rest easy when your hose assemblies are provided by a Gates Authorized E2E Distributor.

Distributors and their customers alike can maximize the value of their Gates industrial hose assemblies and create safer, more productive working environments by following the principles detailed in Gates comprehensive Crimp Data Manual and The Gates Safety Guide – An Inspection and Preventive Maintenance Program for Industrial Hose.

For more information on Gates industrial hose systems visit [gates.com/ih](https://www.gates.com/ih)

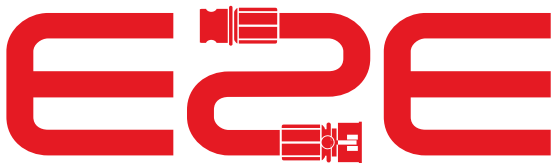

# Gates Safety Training

---

## **SAFETY CONNECTIONS<sup>SM</sup>**

Gates Corporation powers progress by providing quality products and expert support to help you increase production, avoid downtime and decrease maintenance. Gates continues to lead the industry with product innovations and unmatched engineering support to improve fluid power conveyance efficiency, reliability, and economy.



### **PROPER INSTALLATION + PREVENTIVE MAINTENANCE PROCEDURES**

improve workplace safety, reduce downtime, and increase production.

There are several valid reasons to begin a preventive maintenance program. Costly emergency repairs, production downtime and worker safety are just a few. Safety Connections training provides in-depth guidance to avoid these issues to improve industrial hose performance. Ideal for facility personnel responsible for industrial hose management, the Gates Safety Connections program covers the following topics:

- › Industrial Hose Overview
- › Proper Hose Application
- › Industrial Hose Inspections
- › Handling + Maintenance
- › Cleaning + Storage
- › Industrial Hose for Specialty Applications
- › Troubleshooting

## **SAFE HYDRAULICS<sup>TM</sup>**

Preventive maintenance is especially important with hydraulic products. The high pressures and temperatures associated with hydraulics make hose and fitting maintenance, as well as selection, critical. If done correctly, the risk of injury and/or excessive, costly downtime decreases significantly. In addition, there is a growing awareness regarding costs associated with cleaning up a hydraulic spill (EPA). Combining top-quality Gates products with a regular preventive maintenance program will keep your equipment operating at maximum efficiency.



Combining top-quality Gates products with a regular preventive maintenance program will keep your equipment operating at maximum efficiency.



To schedule an onsite safety survey or safety class on Gates Safe Hydraulics & Gates Safety Connections or to request a safety audit visit [GatesSafety.com](http://GatesSafety.com).

# Certifications & Standards

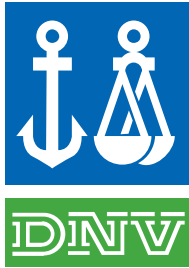

# Where To Buy

---

To find an Authorized Industrial Distributor Near You go to [gates.com/where-to-buy](http://gates.com/where-to-buy)



Authorized End-to-End Distributors specialize in offering crimped, factory-quality industrial hose assemblies that deliver unmatched performance, reliability and safety.

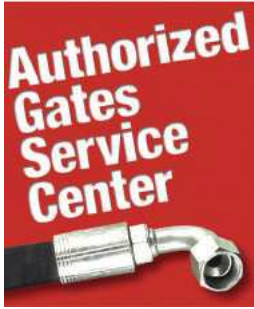

Authorized Gates Service Centers are specially designed to accommodate walk-in or over-the-counter sales of Gates industrial hose and hydraulic products.



Certified Hydraulic Assembly Fabricators (HAF) have received comprehensive training and accreditation from Gates for the crimping of Gates industrial hose and hydraulic assemblies.



Gates Engineering & Services  
361.289.4800

[crp.sales@gates.com](mailto:crp.sales@gates.com)

For worldwide locations go to [gates.com/where-to-buy](http://gates.com/where-to-buy)



Gates Black Gold Distributors specialize in servicing the oil & gas industry with custom-made, API-certified rotary, cementing, choke & kill, and BOP hose assemblies.



Gates Authorized Drive Originator Distributors demonstrate design, installation and application expertise for Gates Poly Chain® Carbon™ Drive Systems in industrial applications.

# Industrial Hose Crimpers



## GC®96 TSi™ Crimper

The GC96TSi is offered in single phase power, 208-260V and crimps up to 6" industrial hose with 550 ton crimping force. Utilizing the optional spacer dies enables crimping up to 2½" 2-wire hydraulic hose. The large crimper head allows assemblies to be made with a wide variety of terminations using crimpable ferrules and sleeves.

### FEATURES:

- › Starter Kit: Operation manual, allen wrench, grease applicator, grease and calipers
- › Calibration Kit: 35 die, spacer dies, calibration manual
- › TEAM Viewer® diagnostics for remote troubleshooting
- › Electronic touch screen allows for fast input of crimper settings
- › Pinch Decompression Measurement
- › Self greasing ratcheting head
- › Horizontal front-end feed makes crimping easier and convenient
- › 2 speed die closure and rapid retract permit fast assembly fabrication
- › 3-phase inverter allows crimper to be used all over the world

Crimper	Product No	Weight (lbs)	Price
GC96 TSi - Includes Foot Pedal and Lifting Rope	7480-9002	1069	\$83,281.63

Dies and Accessories	Product No	Weight (lbs)	Price
Quick Change Tool	7482-7104	2	\$1,501.50
Die Racks [2] holds the dies [hydraulic dies only]; stand or wall mount	7480-7003	48.4	\$1,025.10
GC32-XD/GC96 Stand	7480-7002	242	\$1,845.00
GC96 Spacer Dies with box [for crimping with GC32-XD dies]	7482-9600	31	\$5,542.87
Die Set - 96-610 with box [Min. Crimp O.D. 3.54"; Max. ferrule O.D. 4.63"]	7482-9610	47	\$2,407.92
Die Set - 96-611 with box [Min. Crimp O.D. 4.25"; Max. ferrule O.D. 5.33"]	7482-9611	41	\$2,407.92
Die Set - 96-612 with box [Min. Crimp O.D. 4.92"; Max. ferrule O.D. 6.00"]	7482-9612	40	\$2,016.30
Die Set - 96-613 with box [Min. Crimp O.D. 5.43"; Max. ferrule O.D. 6.52"]	7482-9613	46	\$2,163.23
Die Set - 96-614 with box [Min. Crimp O.D. 6.34"; Max. ferrule O.D. 7.42"]	7482-9614	31	\$2,163.23

**NOTE: For replacement parts, see GC96 TSi Operating Manual. GC32 dies should be ordered from the Hydraulic Price Sheet #35096-00. 96-610 Dies required for calibration.**



## GC®32 TSi™ Crimper

The GC32TSi is offered in 220V single phase. The first smart crimper featuring an intuitive touch screen easily makes hydraulic assemblies from Gates entire hose and coupling product line. The crimper features adjustable retract plus a quick change tool for easy die loading. Gates eCrimp™ data provides up-to-date crimping specs. **Part No. 7480-7004**



## SC32™ Crimper

The SC32 crimper is offered in 110V and 220V single phase versions to match the power supply in your shop. It features the use of the PC707 dies up to 1-1/4". This rugged crimper is designed to cover your shop and counter needs up to 2", 6-spiral. **Part No. 7480-0070 220V**  
**Part No. 7480-0071 110V**



## Power Crimp® 707

The toughest part of using the PC707 is pushing a button. With this precise yet simple crimper, it takes just a few seconds to make factory-quality hose assemblies. It was the first crimper with an electronic digital readout to indicate gauge settings. **Part No. 7480-0043 (no dies)**  
**Part No. 7480-0049 (w/ brackets)**



## MobileCrimp® 4-20

Gates first portable crimper is designed to meet every crimping and application need—anywhere. Easy to use and versatile, the MC4-20 features a digital dial control for accurate crimps. The crimper with stand weighs only 57 pounds. **Part No. 7480-0051**

For additional information reference the Gates Hydraulic Catalog 35093



# Select the Best Equipment for Your Needs

If you need:	Gates Recommends:
<p>An ergonomical 6" industrial hose and 2", 6-spiral hydraulic hose crimper with electronic touch screen control to crimp a wide range of Gates hoses. Gates eCrimp™ data provides up-to-date crimping specs up to 2" and features a compression calculator for crimps above 2".</p>	<b>GC96TSi</b>
<p>A smart crimper with rear-mounted camera and touch screen for factory-quality crimping of all Gates couplings including short bend, block and other complex couplings up to 2", 6-spiral.</p>	<b>GC32TSi</b>
<p>An economical, precise and simple-to-use shop crimper for normal crimps up to 1-1/4" and occasional crimps up to 2".</p>	<b>SC32</b>
<p>An economical, precise and simple-to-use shop crimper for up to 1-1/4".</p>	<b>PC707</b>
<p>A portable, lightweight crimper for remote job sites.</p>	<b>MC4-20</b>

## Crimp with the Precision of Gates



### Quickly Find Hose and Hydraulic Crimp Specifications

Gates eCrimp® database allows Gates end users and distributors to find and print the most up-to-date crimp specifications for Gates hydraulic and industrial hose products. It provides crimping instructions, crimp diameter, maintenance and troubleshooting information for the MobileCrimp 4-20, PC 707, SC32, PC 3000B, PC2001, GC32 TSi, GC96 TSi and Omni Crimp 21.

eCrimp:

- › Reduces downtime with hose assembly guides
- › Eliminates potential dangers of an improperly crimped hose
- › Quickly and easily finds exact crimping specifications from your browser
- › Is the on-board database for the GC32TSi and GC96TSi.
- › Allows you to create custom reports around the products which you use most.

Go to [gates.com/ecrimp](http://gates.com/ecrimp) for more information on the web version and mobile app.

A white calculator icon with a red display and buttons, set against a red background.

**CHECK OUT OUR CRIMPER  
ROI CALCULATOR AT  
[GATES.COM/ROICALCULATOR](http://GATES.COM/ROICALCULATOR)**



# Definitions & Abbreviations

**API Thread**—American Petroleum Institute Thread.

**Conductive**—Rubber designed to transmit electrical current; conducting static electricity

**Coupling**—A device used to attach a hose to a fitting or other hose in a secure, leakproof manner. There are two primary types:

**Permanent**—A coupling that is applied to the hose with crimping or swaging dies and cannot be easily removed. It is referred to as a “one-time coupling.”

**Reusable**—A coupling that can be used more than once. It can be applied to or removed from a hose with the use of simple tools.

**Coupling Joint**—This leak proof connection is achieved by fastening together the mating surfaces of two couplings. The leak proof seal is obtained by any one of these methods:

1. **Washer seal**
2. **Mechanical seal**
3. **Thread seal**

**Ferrule**—The external part of the coupling which serves to hold the insert to the hose.

**GHT**—Garden Hose Thread. See Pipe Thread Usage for compatibility.

**Helix**—Reinforcement formed by spiraling a wire or plastic rod around the cylindrical body of hose—usually to resist collapse or improve minimum bend radius.

**I.D.**—Abbreviation for Inside Diameter.

**Insert**—That part of the coupling which fits into the I.D. of the hose, which often has a threaded end, also called stem or nipple.

**IPT**—Iron Pipe Thread. A general term applying to all pipe threads. See Pipe Thread Usage page.

**MBR**—Abbreviation for Minimum Bend Radius. It's the smallest radius, in inches, around which a hose can be bent without overstressing components, collapsing the hose wall and without substantially reducing fluid flow.

**NPSH**—American Standard Straight Pipe Thread for hose couplings and nipples.

**NPSM**—American Standard Straight Pipe Thread—Common name, straight pipe thread for mechanical joints.

**NPT**—American Standard Taper Pipe Thread—Common name, tapered pipe thread.

**NPTF**—American Standard Dryseal Pipe Thread—Common name, dryseal for pressure type joints without sealer.

**O.D.**—Abbreviation for Outside Diameter.

**Resistant**—Rubber designed to prevent transmission of electrical current; nonconductive.

**Shank**—That part of the coupling which fits into the I.D. of the hose.

**Chart No. 1**  
Coupling Joints

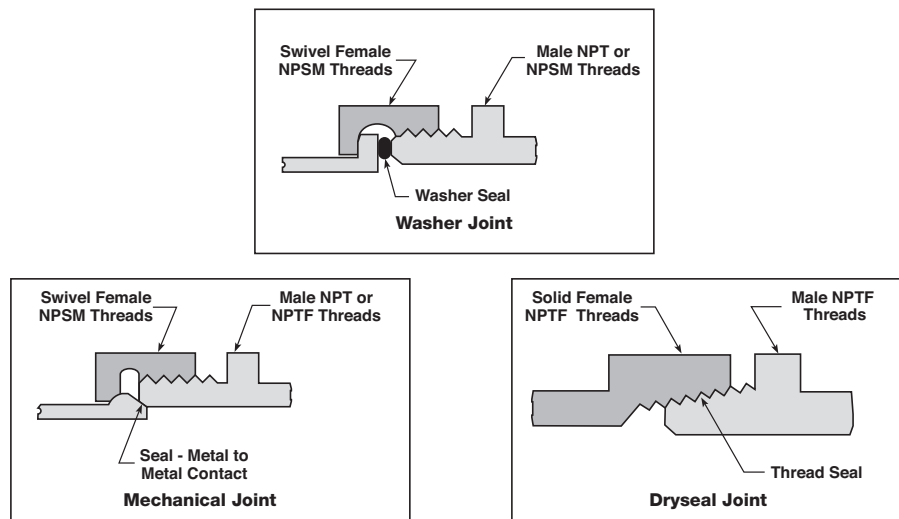

# Selection of Hoses & Couplings

There are many types of industrial hoses – all designed for a particular application or several related applications. When hoses are mated with the proper couplings and used in the correct application, hose assemblies will give long, trouble-free service.

This catalog is designed to make certain that you obtain long service life by:

- › Helping you select the proper hose and coupling from among the many types available.
- › Giving you suggestions on how to take reasonable care of the hose assembly and maintain it for maximum service life.

Reference the STAMPED guide for proper hose selection. Select one of the recommended couplings from the hose coupling information section. Couplings are recommended in each individual Hose Specification Section.

For example: 19. Check coupling compatibility in Industrial Hose Coupling Assembly Guide #39505 with the material to be handled.

Provide for proper care and maintenance of the assembly. Certain critical applications require the use of just one specific hose or group of hoses. **DO NOT SUBSTITUTE.**

Critical Application	Recommended Gates Hoses
Steam	Select a hose that meets the application requirements from Steam Hose Section only.
LP Gas	Fuel Master LP350
Corrosive Chemicals (Acids—Bases)	Select a hose that meets the application requirements from Chem Master Hose Section only.
Edible Products	Select a hose that meets application requirements from Beverage and Food Hoses. Hose must have FDA tube stock.

### SPECIAL HOSES ARE AVAILABLE

Gates can furnish special hoses for specific applications. For information, contact your local field representative – furnishing complete details of hose application.

Rubber hoses are used basically to convey material. They are used for a variety of reasons, but principally for:

- › Flexibility; allows for changes in alignment, hookup or outlet
- › Absorbing vibration
- › Resistance to corrosive fluids
- › Resistance to abrasion
- › Providing a closed system

In applying any product, the more you know about the application, the better the product you choose to meet the needs of the application. This is particularly true with hose because of the many variables involved.

Each type of hose and coupling is designed to give satisfactory, safe service life for a particular application. To obtain this service life, the user should:

- › Select the proper hose and couplings for the application
- › Take reasonable care of the hose assembly while it is in service

- › Maintain the hose assembly in good working condition
- › Observe all applicable safety regulations

If a hose assembly was incorrectly selected to solve an application problem, there is very little that care and maintenance can do to prolong its service life. It's very simple: hoses will fail soon regardless of the care and maintenance provided if they are misapplied.

When designing a system with rubber hose, engineering principles regarding materials always apply. Take advantage of the outstanding characteristics of rubber materials listed on the Characteristics and Resistance Information for Hose Tube and Cover Compounds page and avoid those conditions that shorten hose life. Some of these conditions are:

- › Exposure to higher-than-rated temperatures.
- › Exposure to severe external abuse such as kinking, pulling, excessive bending.
- › Exposure to corrosive fluids to which hose has little resistance.
- › Subjecting hose to higher than rated working pressure/high surge pressure.

The process of selecting hoses from Industrial Hose Products #39496-000 or the following Data Pages usually is resolved in one of two ways:

- › Making the optimum choice from several possible selections for an application.
- › Making the only choice, which satisfies all the requirements of a somewhat special application; i.e., transfer of LP Gas.

Hoses are versatile, and it's often possible to use one type of hose for several different applications. However, certain specific applications are critical and/or hazardous, and the only type of hose used should be the one Gates recommends for that application. Some of the critical or hazardous applications involving hoses are:

- › Steam
- › Liquid Petroleum Gas (LPG)
- › Corrosive chemicals
- › Air Drill operation

Refer to the product description pages in this catalog for details of hoses used in these applications.

The hoses listed in this Hose Finder may be found in one or more additional Gates catalogs or Market Specifications publications.

The Hose Finder section of this catalog is intended to give you a reference for quickly locating standard line hoses for a given application. Hoses are listed by size (I.D.) and rated working pressure. Pertinent specification information is also provided for each hose.

### Precautionary Notes

**Not all of the sizes shown are stock items and may require minimum order quantities. In addition, many of the larger diameter hoses (water, material handling, etc.) are made to order. For availability, delivery and pricing information refer to your Industrial Hose Products #39496-000, Customer Service Representative in Denver or your local Gates Representative.**

# Selection of Hoses & Couplings

---

Proper hose selection is the first step in preventive maintenance. Selecting the best product for the application will allow you to obtain the maximum life expectancy from the product for the most value.

**When selecting the correct hose, use the acronym STAMPED as your guide to defining critical and important characteristics:**

## **S - Size:**

- › I.D. [inside diameter] and O.D. [outside diameter]
- › Length
- › Flow rate requirements [GPM for liquids; CFM for gases].

## **T - Temperature:**

- › Consider ambient and internal temperatures as well as temperature impact on the material being conveyed.
- › Minimum and Maximum °F.

## **A - Application:**

- › How will the hose be used?
- › How often will the hose be used [continuous, intermittent, seldom]?
- › What are the environmental conditions?
- › Special hose construction needs [crush resistant]?
- › Conductivity requirements [non-conductive, static conductive, static dissipating]?
- › Government or industry standard requirements?

## **M - Material Being Conveyed:**

- › Chemical name[s], concentration [%], temperature, and state – liquid, solid or gas
- › Food, pharmaceuticals, cosmetics

## **P - Pressure:**

- › What is the working pressure?
- › What is the maximum surge pressure?
- › Is there a vacuum?

## **E - End Requirements**

- › What type of terminations? [Straight, male, etc.]

## **D - Delivery**

- › Identify how many items and when they need to be supplied.
  - › Distributors — Call customer service
  - › End Users — Call distributors
- › Are there any special packaging or branding requirements?

# ARPM Tolerances

## 1. Hand Built Hose - Wire and Nonwire (W and SB)

Size (In.)	I.D. (In.)	O.D. (In.)
3/4 and under	± .031	± .031
Over 3/4 through 2	± .031	± .063
Over 2 through 3-1/2	± .063	± .094
Over 3-1/2 through 4	± .063	± .094
Over 4 through 6-5/8	+ .063	+ .125
Over 8 through 12	+ .250	+ .250

## 2. Vertical Braid Hose (B) & Spiral Hose

Size (In.)	I.D. (In.)	O.D. (In.)
3/16	± .025	± .031
1/4 through 3/4	± .031	± .031
1	± .047	± .047
1-1/4 through 1-1/2	± .063	± .063

## 3. Horizontal Braid Hose (HB and HW)

Size (In.)	I.D. (In.)	O.D. (In.)
1/4, 5/16, 3/8	± .016	± .031
1/2, 5/8, 3/4	± .023	± .031
1	± .028	± .031
1-1/4, 1-1/2	± .031	± .063
2	+ .031	+ .063
2-1/2	± .039	± .063
3, 3+1/2, 4	± .063	± .063

## 4. Specified Cut Length of Hose\*

Length (In.)	Tolerance (In.)
12 and under	± .125
Over 12 through 24	± .188
Over 24 through 36	± .250
Over 36 through 48	± .375
Over 48 through 72	± .500
Over 72	± 1%

\* Helix wire hoses which can be coiled can appear shorter than the factory cut length. This phenomenon is normal, and the hose(s) will return to the factory cut length upon initial pressurization.

## 5. Made-To-Order Hoses Wire-Inserted Construction, Gates

Length (Ft.)	Tolerance (In.)
Up to 5	± 1.0
5 to 10	± 1.5
10 to 20	± 2.5
over 20	± 1%

## ROUNDNESS TOLERANCE

For vertical braid and spiral hose made with non-mandrel process, hoses can be slightly out of round. Using calipers, measure the OD at minimum and maximum diameters.

$$\frac{\text{MIN OD}}{\text{MAX OD}} \times 100 > 80\%$$

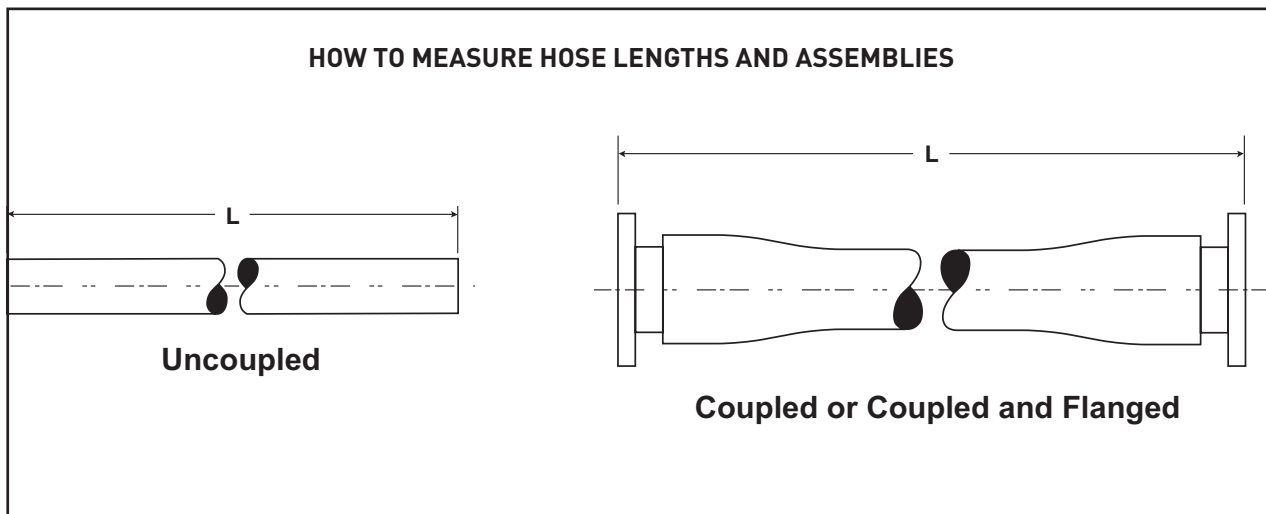
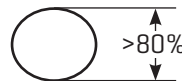

Hose or hose assembly lengths ("L") are measured as shown above, unless otherwise specified.

# Care and Maintenance of Hose

[Reprinted from ARPM Hose Handbook 9th Edition]

Hose has a limited life and the user must be alert to signs of impending failure, particularly when the conditions of service include high working pressures and/or the conveyance or containment of hazardous materials. The periodic inspection and testing procedures described here provide a schedule of specific measures which constitute a minimum level of user action to detect signs indicating hose deterioration or loss of performance before conditions leading to malfunction or failure are reached.

**SAFETY WARNING: Failure to properly follow the manufacturer's recommended procedures for the care, maintenance and storage of a particular hose might result in its failure to perform in the manner intended and might result in possible damage to property and serious bodily injury.**

General instructions are also described for the proper storage of hose to minimize deterioration from exposure to elements or environments which are known to be deleterious to rubber products. Proper storage conditions can enhance and extend substantially the ultimate life of hose products.

## GENERAL CARE AND MAINTENANCE OF HOSE

Hose should not be subjected to any form of abuse in service. It should be handled with reasonable care. Hose should not be dragged over sharp or abrasive surfaces unless specifically designed for such service. Care should be taken to protect hose from severe end loads for which the hose or hose assembly were not designed. Hose should be used at or below its rated working pressure; any changes in pressure should be made gradually so as to not subject the hose to excessive surge pressures. Hose should not be kinked or be run over by equipment. In handling large size hose, dollies should be used whenever possible; slings or handling rigs, properly placed, should be used to support heavy hose used in oil suction and discharge service.

## GENERAL TEST AND INSPECTION PROCEDURES FOR HOSE

An inspection and hydrostatic test should be made at periodic intervals to determine if a hose is suitable for continued service.

A visual inspection of the hose should be made for loose covers, kinks, bulges or soft spots which might indicate broken or displaced reinforcement. The couplings or fittings should be closely examined, if there is any sign of movement of the hose from the couplings, the hose should be removed from service.

The periodic inspection should include a hydrostatic test for one minute at 150% of the recommended working pressure of the hose. An exception to this would be woven jacketed fire hose\*. During the hydrostatic test, the hose should be straight, not coiled or in a kinked position.

Water is the usual test medium, but following the test the hose may be flushed with alcohol to remove traces of moisture. A regular schedule for testing should be followed and inspection records maintained.

**SAFETY WARNING: Before conducting any pressure tests on hose, provision must be made to ensure the safety of the personnel performing the tests and to prevent any possible damage to property. Only trained personnel using proper tools and procedures should conduct pressure tests.**

\* Woven jacket fire hose should be tested in accordance with the service test provisions contained in the current edition of National Fire Protection Association Bulletin No. 1962 - Standard for the Inspection, Care, and Use of Fire Hose, Couplings, and Nozzles and the Service Testing of Fire Hose.

## SAFETY WARNING (FOR PRESSURE TESTING)

1. Air or any other compressible gas must never be used as the test media because of the explosive action of the gas, should a failure occur. Such a failure might result in possible damage to property and serious bodily injury.
2. Air should be removed from the hose by bleeding it through an outlet valve while the hose is being filled with the test medium.
3. Hose to be pressure tested must be restrained by placing steel rods or straps close to each end and at approximate 3 m (10 foot) intervals along its length to keep the hose from "whipping" if failure occurs; the steel rods or straps are to be anchored firmly to the test structure but in such a manner that they do not contact the hose which must be free to move.
4. The outlet end of the hose is to be restrained so that a blown-out fitting will be stopped.
5. Provisions must be made to protect testing personnel from the forces of the pressure media if a failure occurs.
6. Testing personnel must never stand in front of, or in back of, the ends of a hose being pressure tested.
7. If liquids such as gasoline, oil, solvent or other hazardous fluids are used as the test fluid, precautions must be taken to protect against fire or other damage should a hose assembly fail and the test liquid be sprayed over the surrounding area.

The Association for Rubber Products Manufacturers has separately published a series of Hose Technical Bulletins describing hoses designed for different applications which detail maintenance, testing and inspection recommendations. Reference should be made to the current ARPM Catalog of Publications, to determine the availability of the latest editions ([www.arpminc.org](http://www.arpminc.org)).

## PUBLICATION NO.

- IP 11-1 Steam Hose
- IP 11-2 Anhydrous Ammonia Hose
- IP 11-4 Oil Suction and Discharge Hose

# Care and Maintenance of Hose

---



**To increase hose life it is always best to drain hose after each use.**

## Hose Cleaning

There are many different methods used to clean hose assemblies. An apron, safety glasses or face shield, rubber boots and gloves should be worn to help protect the person doing the cleaning from potential injury. Some suggested methods for select hoses in this catalog are listed below. Which method to use and how often cleaning should be performed is based on the following:

- › Type of hose
- › Residual material in the hose
- › Cleanliness requirements for the application
- › Cleaning facilities available
- › Consideration for disposal of the residual material and cleaning solutions(s)
- › Requirements for special applications such as foods, pharmaceuticals, etc.

## Solution Recommendations

1. Cleaning solutions should be chosen that will dissolve or remove the residual material without damaging the hose assembly.
2. A dilute solution of soap in water can often be sufficient. CAUTION – Some chemicals, such as concentrated acids or bases, can react with water releasing heat and byproducts, and possibly splatter.
3. Consult the MSDS of the material being cleaned to identify potential cleaning solutions.
4. After identifying potential cleaning solutions, check Chemical Resistance Table in this catalog for compatibility with hose tube and cover.
5. Non-compatibility of a cleaning solution can cause damage to the hose.

## Flushing or Immersing in a Cleaning Bath

1. Do not exceed the maximum working pressure or temperature for the hose.
2. The cover of the hose should also be washed or wiped to remove any residual material.

## Steam Cleaning

1. Steam cleaning is **NOT** generally recommended. High temperatures can accelerate aging of a hose and shorten service life.
2. Do not exceed the maximum temperature rating of the hose. Doing so can cause defects such as tube de-lamination (reducing tube to reinforcement adhesion), tube cracking or tube flow leaving thin spots.
3. Never use superheated steam! This will exaggerate the potential damages noted above. Only “open-end” 50 psi steam should be used.
4. If the hose has blockage, remove it before introducing steam.
5. If the steam source has a wand attached, use caution inserting the wand so that physical damage to the hose is not caused. Sharp edges on the wand can cut the tube, and thin spots could occur where the hot wand contacts the tube.

## Recommended Cleaning of Chemical Hose

1. Drain the hose after each use.
2. Flush with water or other neutralizing cleaning solution.
3. Properly dispose of drained fluid and cleaning waste.
4. Between uses, store the hose in a clean, dry environment away from sunlight.
5. Avoid cross contamination. Dedicate a hose to handle a specific chemical.

## Recommended Cleaning of Food Hose

1. Drain the hose after each use.
2. Flush with water or other cleaning solution.
3. Properly dispose of drained material and cleaning waste.
4. Between uses, store the hose in a clean, dry environment away from sunlight.
5. Avoid cross contamination. Dedicate a hose to handle a specific food material.

# Care and Maintenance of Hose

## Storage

Rubber hose products in storage can be affected adversely by temperature, humidity, ozone, sunlight, oils, solvents, corrosive liquids and fumes, insects, rodents and radioactive materials.

The appropriate method for storing hose depends to a great extent on its size (diameter and length), the quantity to be stored and the way in which it is packaged. Hose should not be piled or stacked to such an extent that the weight of the stack creates distortions on the length stored at the bottom.

Since hose products vary considerably in size, weight and length, it is not practical to establish definite recommendations on this point. Hose having a very light wall will not support as much load as could a hose having a heavier wall or hose having a wire reinforcement. Hose which is shipped in coils or bales should be stored so that the coils are in a horizontal plane.

Whenever feasible, rubber hose products should be stored in their original shipping containers, especially when such containers are wooden crates or cardboard cartons which provide some protection against the deteriorating effects of oils, solvents and corrosive liquids; shipping containers also afford some protection against ozone and sunlight.

Certain rodents and insects will damage rubber hose products and adequate protection from them should be provided.

Cotton jacketed hose should be protected against fungal growths if the hose is to be stored for prolonged periods in humid conditions in excess of 70 percent.

The ideal temperature for the storage of rubber products ranges for 50° to 70°F (10-21°C) with a maximum limit of 100°F (38°C). If stored below 32°F (0°C), some rubber products become stiff and would require warming before being placed in service. Rubber products should not be stored near sources of heat, such as radiators, base heaters, etc., nor should they be stored under conditions of high or low humidity.

To avoid the adverse effects of high ozone concentration, rubber hose products should not be stored near electrical equipment that may generate ozone or be stored for any lengthy period in geographical areas of known high ozone concentration. Hose should not be stored in locations where the ozone level exceeds the National Institute of Occupational Safety and Health's upper limits of 0.10 ppm. Exposure to direct or reflected sunlight – even through windows – should also be avoided. Uncovered hose should not be stored under fluorescent or mercury lamps which generate light waves harmful to rubber.

Storage areas should be relatively cool and dark, and free of dampness and mildew. Items should be stored on a first-in, first-out basis, since even under the best of conditions, an unusually long shelf life could deteriorate certain rubber products.

## Decimal and Millimeter Equivalent of Fractions

Inches		Millimeters
Fractions	Decimals	
1/64	.015625	.397
1/32	.03125	.794
3/64	.046875	1.191
1/16	.0625	1.588
5/64	.078125	1.984
3/32	.09375	2.381
7/64	.109375	2.778
1/8	.125	3.175
9/64	.140625	3.572
5/32	.15625	3.969
11/64	.171875	4.366
3/16	.1875	4.763
13/64	.203125	5.159
7/32	.21875	5.556
15/64	.234375	5.953
1/4	.250	6.350
17/64	.265625	6.747
9/32	.28125	7.144
19/64	.296875	7.541
5/16	.3125	7.938
21/64	.328125	8.334
11/32	.34375	8.731
23/64	.359375	9.128
3/8	.375	9.525
25/64	.390625	9.922
13/32	.40625	10.319
27/64	.421875	10.716
7/16	.4375	11.113
29/64	.453125	11.509
15/32	.46875	11.906
31/64	.484375	12.303
1/2	.500	12.700

Inches		Millimeters
Fractions	Decimals	
33/64	.515625	13.097
17/32	.53125	13.494
35/64	.546875	13.891
9/16	.5625	14.288
37/64	.578125	14.684
19/32	.59375	15.081
39/64	.609375	15.478
5/8	.625	15.875
41/64	.640625	16.272
21/32	.65625	16.669
43/64	.671875	17.066
11/16	.6875	17.463
45/64	.703125	17.859
23/32	.71875	18.256
47/64	.734375	18.653
3/4	.750	19.050
49/64	.765625	19.447
25/32	.78125	19.844
51/64	.796875	20.241
13/16	.8125	20.638
53/64	.828125	21.034
27/32	.84375	21.431
55/64	.859375	21.828
7/8	.875	22.225
57/64	.890625	22.622
29/32	.90625	23.019
59/64	.921875	23.416
15/16	.9375	23.813
61/64	.953125	24.209
31/32	.96875	24.606
63/64	.984375	25.003
1	1.000	25.400



# Gates Engineering & Services

**Gates delivers premium Engineering & Services** to decrease downtime, increase safety for the oil & gas market, and foster risk management. It only takes one hose-related incident on a rig to shut down your entire operation. Gates E&S is dedicated to providing world-class products and support services to minimize downtime.

## Gates Hose Management System<sup>SM</sup> (GHMS)

Hose management is key in maximizing production. The Gates Hose Management System is a comprehensive Lifecycle Management System for critical hose assemblies.

Through a document control system, Sentry™ Tag & Track records the life cycle and performance history of a hose, documenting when it's been registered, inspected, tested, recertified, and tracked through RFID technology.



## Inspection, Maintenance & Recertification (IMR)

IMR includes a visual inspection through an endoscopic hose analysis, a thorough cleaning of the hose—both internally and externally—as well as a pass/fail rating at every stage. Gates then performs hose maintenance, makes replacement recommendations, and runs a hydrostatic test to ensure the integrity of the hose meets the demands of flexible pipe or hose assembly application. Gates IMR is an essential component to any successful equipment maintenance program.

## Products and Services for Critical Hose Assemblies

- › **Hydraulic, Industrial, and Rotary Hoses** rated up to 15,000 psi working pressure.
- › **Rig-Site Survey** where a Gates hose specialist performs a full, onsite risk assessment of your FHA.
- › **Large Bore Cut & Couple** program for big, critical application hose assemblies.
- › **MobileCrimp®** for lightweight, versatile crimpers powerful enough to crimp 4 spiral-wire hose on location.
- › **Hydraulic Fluid Flushing** descales sediment and removes contaminants from the fluid, reducing wear on the line.
- › **Breathing Air Manifolds** to be used in oil & gas environments where toxic gases (H<sub>2</sub>S) are present.
- › **Hose Rental** services for short-term projects, as an onsite back up contingency during Frac jobs.

## POTENTIAL CONSEQUENCES OF HOSE NEGLIGENCE



Downtime and loss of production



Endangerment of workers



Environmental spills and clean-up costs



Equipment replacement costs

## Agriculture Hose

### Ag Master™ Spray 600

Formerly - Thermo AG™ 570



AGRICULTURE
AIR BREATHING
AIR DUCT
AIR AND MULTI-PURPOSE
CHEMICAL
FOOD AND BEVERAGE
MARINE AND ENGINE
MATERIAL HANDLING
MINING
OILFIELD
PETROLEUM
PRESSURE WASH AND WASHDOWN
STEAM
WATER
CLAMPS
COUPLINGS AND FERRULES
HOSE FINDER
CHEMICAL RESISTANCE TABLE

Color	Hose I.D.		Hose O.D.		Max. W.P.*		Vac.*	MBR	Wt. Per ft	Length	Std. Pack	Pkg Code	Stock or MTO (ft)	Gates Item No.	List Price Per ft
	(in)	(mm)	(in)	(mm)	(psi)	(Bar)	(In. Hg)	(in)	(Lbs.)	(ft)					
Yellow	3/8	9.5	.67	17.0	600	41.4	25.0	4.0	.12	300	PLT	T	Stock	4465-1701	\$3.20
Yellow	3/8	9.5	.67	17.0	600	41.4	25.0	4.0	.12	400	PLT	T	Stock	4465-1702	3.20
Yellow	1/2	12.7	.81	20.6	600	41.4	25.0	5.0	.17	300	PLT	T	Stock	4465-1704	3.74
Yellow	1/2	12.7	.81	20.6	600	41.4	25.0	5.0	.17	400	PLT	T	Stock	4465-1705	3.74
Yellow	3/4	19.1	1.08	27.4	600	41.4	25.0	6.0	.27	300	PLT	T	Stock	4465-1706	7.10

NOTE: \* Working Pressure and Vacuum at +72°F (+22°C).

**RECOMMENDED FOR:** Spraying lawns, trees and similar applications with diluted solutions of water and oil based pesticides and herbicides.

**CAUTION:** For pesticides or herbicides containing more than 2% Toluene or Xylene, use Gates Chem Master™ Paint Spray. Maximum temperature dependent on pesticide, herbicide or chemicals conveyed. For temperatures above +120°F (+49°C), contact Denver Product Application (303) 744-5070.

**TEMPERATURE:** -10°F to +130°F (-23°C to +55°C).

**CONSTRUCTION:**  
**Tube:** Type G (PVC). Yellow.  
**Reinforcement:** Synthetic, high tensile textile cord.  
**Cover:** Type G (PVC). Yellow. Striated.  
**Design Factor:** 3:1

**COUPLINGS:** 8, 14 or 15, 21 (multiple clamps required), 48, 72 Gates Power Crimp® or 75 Gates GLX® couplings. Reference the Hose Coupling Section.

## Agriculture Hose

### Ag Master™ Spray 800

Formerly - Thermo AG™ 800



Color	Hose I.D.	Hose O.D.	Max. W.P.*	Vac.*	MBR	Wt. Per ft	Length	Std. Pack	Pkg Code	Stock or MTO	Gates Item No.	List Price Per ft		
	(in)	(mm)											(in)	(mm)
Green	3/8	9.5	.69	17.5	800	55.2	25.0	4.0	.14	300	PLT T	Stock	4465-1361	\$3.69
Green	3/8	9.5	.69	17.5	800	55.2	25.0	4.0	.14	400	PLT T	MTO	4465-1362	3.69
Green	1/2	12.7	.84	21.3	800	55.2	25.0	5.0	.18	300	PLT T	Stock	4465-1371	4.70
Green	1/2	12.7	.84	21.3	800	55.2	25.0	5.0	.18	400	PLT T	MTO	4465-1372	4.70
Green	3/4	19.1	1.14	29.0	800	55.2	25.0	6.0	.30	300	PLT T	Stock	4465-1381	8.46
Green	3/4	19.1	1.14	29.0	800	55.2	25.0	6.0	.30	400	PLT T	Stock	4465-1382	8.46

NOTE: \* Working Pressure and Vacuum at +72°F (+22°C).

**RECOMMENDED FOR:** Spraying lawns, trees and similar applications with diluted solutions of water and oil based pesticides and herbicides.

**CAUTION:** For pesticides or herbicides containing more than 2% Toluene or Xylene, use Gates Chem Master™ Paint Spray. Maximum temperature dependent on pesticide, herbicide or chemicals conveyed. For temperatures above +120°F (+49°C), contact Denver Product Application (303) 744-5070.

**TEMPERATURE:** -10°F to +130°F (-23°C to +55°C).

**CONSTRUCTION:**  
**Tube:** Type G (PVC). Green.  
**Reinforcement:** Synthetic, high tensile textile cord.  
**Cover:** Type G (PVC). Green. Striated.  
**Design Factor:** 3:1

**COUPLINGS:** 8, 14 or 15, 21 (multiple clamps required), 48, 72 Gates Power Crimp®, 75 Gates GLX® or 82 Gates SS couplings. Reference the Hose Coupling Section.

AGRICULTURE

AIR BREATHING

AIR DUCT

AIR AND MULTI-PURPOSE

CHEMICAL

FOOD AND BEVERAGE

MARINE AND ENGINE

MATERIAL HANDLING

MINING

OILFIELD

PETROLEUM

PRESSURE WASH AND WASHDOWN

STEAM

WATER

CLAMPS

COUPLINGS AND FERRULES

HOSE FINDER

CHEMICAL RESISTANCE TABLE

## Agriculture Hose

### Ag Master™ (200-250)



Color	Hose I.D.		Hose O.D.		Max. W.P.		Vac.	MBR	Wt. Per ft	Length	Std. Pack	Pkg Code	Stock or MTO	Gates Item No.	List Price Per ft
	(in)	(mm)	(in)	(mm)	(psi)	(Bar)									
Black	1/4	6.4	.50	12.7	200	13.8	30.0	3.0	.09	600	Reel	J	Stock	3204-1079	\$1.05
Black	3/8	9.5	.66	16.8	200	13.8	30.0	3.0	.00	600	Reel	J	Stock	3204-1080	1.50
Black	1/2	12.7	.81	20.6	200	13.8	30.0	5.0	.19	600	Reel	J	Stock	3204-1081	1.79
Black	5/8	15.9	.97	24.6	200	13.8	30.0	6.0	.26	600	Reel	J	Stock	3204-1082	2.15
Black	3/4	19.1	1.15	29.2	200	13.8	30.0	6.0	.32	600	Reel	J	Stock	3204-1083	2.51
Black	1	25.4	1.40	35.6	200	13.8	30.0	8.0	.44	350	Reel	XX	Stock	3204-1084	4.52
Black	1 1/4	31.8	1.73	43.9	250	17.2	30.0	10.0	.68	300	Reel	XX	Stock	3204-1085	6.44
Black	1 1/2	38.1	1.98	50.3	250	17.2	30.0	12.0	.79	250	Reel	XX	Stock	3204-1086	8.04

NOTE: Pressure ratings can only be obtained with proper coupling procedures.

**RECOMMENDED FOR:** Designed for agricultural spraying applications, such as dilute solutions of herbicides and fertilizers. Can also be used for air and water applications requiring maximum flexibility in the agriculture industry. Outstanding resistance to heat and ozone.

**TEMPERATURE:** -40°F to +200°F (-40°C to +93°C) continuous service.

**CONSTRUCTION:** **Tube:** Type P (EPDM). Black.  
**Reinforcement:** Synthetic, high tensile textile cord.  
**Cover:** Type P (EPDM). Black. All sizes through 1/2" are perforated.

**COUPLINGS:** 19 (up through 1/2" only), 1, 3 or 4, (up through 1/2" with 20 brass ferrules, up through 1" with bands), or 75 Gates GLX®. Reference the Hose Coupling Section.

**STANDARDS:** **Tube:** ARPM (Class C) Limited oil-resistance.  
**Cover:** ARPM (Class C) Limited oil-resistance.

AGRICULTURE

AIR BREATHING

AIR DUCT

AIR AND MULTI-PURPOSE

CHEMICAL

FOOD AND BEVERAGE

MARINE AND ENGINE

MATERIAL HANDLING

MINING

OILFIELD

PETROLEUM

PRESSURE WASH AND WASHDOWN

STEAM

WATER

CLAMPS

COUPLINGS AND FERRULES

HOSE FINDER

CHEMICAL RESISTANCE TABLE

## Agriculture Hose

### Ag Master™ Solution 150SD

Formerly - Barracuda®



Color	Hose I.D.		Hose O.D.		Max. W.P.		Vac.	MBR	Wt. Per ft	Length	Std. Pack	Pkg Code	Stock or MTO	Gates Item No.	List Price Per ft
	(in)	(mm)	(in)	(mm)	(psi)	(Bar)	(In. Hg)	(in)	(Lbs.)	(ft)			(ft)		
Black	1 1/4	31.8	1.61	40.9	150	10.3	30.0	5.0	.53	100	100	T	Stock	4686-0068	\$9.00
Black	1 1/2	38.1	1.86	47.2	150	10.3	30.0	6.0	.60	100	100	T	Stock	4686-0069	10.85
Black	2	50.8	2.36	59.9	150	10.3	30.0	8.0	.79	100	100	T	Stock	4686-0071	12.55
Black	2 1/2	63.5	2.96	75.2	150	10.3	30.0	10.0	1.38	100	100	T	Stock	4686-0070	15.60
Black	3	76.2	3.54	89.9	150	10.3	30.0	14.0	1.82	100	100	T	Stock	4686-0072	17.30
Black	4	101.6	4.54	115.3	150	10.3	30.0	18.0	2.55	100	100	T	Stock	4686-0073	24.60

**RECOMMENDED FOR:** Medium to light-duty water suction/discharge for agricultural, construction and industrial applications. The EPDM tube is specially compounded to handle mild chemicals and a variety of solutions including Lasso\*, Lasso II\* and Freedom\*. (\*Registered Trademarks of Monsanto)

**TEMPERATURE:** -40°F to +180°F (-40°C to +82°C).

**CONSTRUCTION:** **Tube:** Type P (EPDM). Black.  
**Reinforcement:** Synthetic, high tensile textile with steel wire helix.  
**Cover:** Type P (EPDM). Black with green stripe.  
**Design Factor:** 3:1

**COUPLINGS:** 5, 6, 7, 8, 49 or 78 all sizes. Reference the Hose Coupling Section.

AGRICULTURE

AIR BREATHING

AIR DUCT

AIR AND MULTI-PURPOSE

CHEMICAL

FOOD AND BEVERAGE

MARINE AND ENGINE

MATERIAL HANDLING

MINING

OILFIELD

PETROLEUM

PRESSURE WASH AND WASHDOWN

STEAM

WATER

CLAMPS

COUPLINGS AND FERRULES

HOSE FINDER

CHEMICAL RESISTANCE TABLE

## Agriculture Hose

### Ag Master™ PVC XTreme™ (90-100) SD



AGRICULTURE
AIR BREATHING
AIR DUCT
AIR AND MULTI-PURPOSE
CHEMICAL
FOOD AND BEVERAGE
MARINE AND ENGINE
MATERIAL HANDLING
MINING
OILFIELD
PETROLEUM
PRESSURE WASH AND WASHDOWN
STEAM
WATER
CLAMPS
COUPLINGS AND FERRULES
HOSE FINDER
CHEMICAL RESISTANCE TABLE

Color	Hose I.D.		Hose O.D.		Max. W.P.*		Vac.*	MBR	Wt. Per ft	Length	Std. Pack	Pkg Code	Stock or MTO (ft)	Gates Item No.	List Price Per ft
	(in)	(mm)	(in)	(mm)	(psi)	(Bar)									
Black	1 1/4	31.8	1.75	44.5	100	6.9	30.0	3.0	.45	100	PLT	T	Stock	7744-1500	\$7.89
Black	1 1/2	38.1	1.97	50.0	100	6.9	30.0	3.0	.50	100	PLT	T	Stock	7744-1501	8.99
Black	2	50.8	2.54	64.5	100	6.9	30.0	5.0	.73	100	PLT	T	Stock	7744-1502	10.60
Black	3	76.2	3.64	92.5	90	6.2	30.0	7.0	1.25	100	PLT	T	Stock	7744-1503	18.46

NOTE: \* Working Pressure and Vacuum at +72°F (+22°C).

**RECOMMENDED FOR:** Heavy-duty suction and discharge of liquids in the construction, rental, and agricultural industries. Excellent for agricultural chemicals, liquid fertilizers, and dewatering. Rated for both suction and discharge.

**TEMPERATURE:** -40°F to +140°F (-40°C to +66°C) continuous service.

**CONSTRUCTION:**  
**Tube:** Type P (EPDM). Black with polyethylene helix.  
**Reinforcement:** Textile braid.  
**Cover:** Type P (EPDM). Black with polyethylene helix.

**COUPLINGS:** 1, 6, 7, 49 or 78. Reference the Hose Coupling Section.

## Agriculture Hose

### Ag Master™ PVC Solution (35-80) SD Formerly - Master-Flex® 300 EPDM



Color	Hose I.D.		Hose O.D.		Max. W.P.*		Vac.*	MBR	Wt. Per ft	Length	Std. Pack	Pkg Code	Stock or MTO	Gates Item No.	List Price Per ft
	(in)		(mm)												
Black	1	25.4	1.34	34.0	80	5.5	28.0	4.0	.23	100	PLT	T	Stock	7744-5201	\$4.76
Black	1 1/4	31.8	1.61	40.9	70	4.8	28.0	5.0	.30	100	PLT	T	Stock	7744-5202	6.45
Black	1 1/2	38.1	1.96	49.8	60	4.1	28.0	6.0	.49	100	PLT	T	Stock	7744-5203	7.23
Black	2	50.8	2.49	63.2	60	4.1	28.0	9.0	.69	100	PLT	T	Stock	7744-5204	10.32
Black	2 1/2	63.5	3.00	76.2	50	3.4	28.0	11.0	.91	100	PLT	T	Stock	7744-5205	15.72
Black	3	76.2	3.60	91.4	50	3.4	28.0	12.0	1.10	100	PLT	T	Stock	7744-5206	19.88
Black	4	101.6	4.69	119.1	45	3.1	28.0	17.0	1.80	100	PLT	T	Stock	7744-5207	33.35
Black	6	152.4	6.86	174.2	35	2.4	28.0	27.0	3.10	100	PLT	T	Stock	7744-5208	55.79

NOTE: \* Working Pressure and Vacuum at +72°F (+22°C).

**RECOMMENDED FOR:** Suction and discharge applications where lightweight, flexible hose is needed for transferring mild diluted chemicals and agricultural spray and fertilizer applications. Good for septic service and transferring light abrasives. Reference Gates Chemical Resistance Table.

**TEMPERATURE:** -30°F to +140°F (-34°C to +60°C) continuous service.

**CONSTRUCTION:** **Tube:** Type P (EPDM). Black.  
**Reinforcement:** Polyethylene helix. Green.  
**Cover:** Type G (PVC). Black with green helix. Corrugated.  
**Design Factor:** 3:1

**COUPLINGS:** 1, 6, 7, 49 or 78. Reference the Hose Coupling Section.

**STANDARDS:** **Tube:** ARPM (Class B) Medium oil-resistance.

AGRICULTURE

AIR BREATHING

AIR DUCT

AIR AND MULTI-PURPOSE

CHEMICAL

FOOD AND BEVERAGE

MARINE AND ENGINE

MATERIAL HANDLING

MINING

OILFIELD

PETROLEUM

PRESSURE WASH AND WASHDOWN

STEAM

WATER

CLAMPS

COUPLINGS AND FERRULES

HOSE FINDER

CHEMICAL RESISTANCE TABLE



## Agriculture Hose

### Ag Master™ PVC Solution (30-90) SD Clear

Formerly - Master-Flex® 101CL



#### Smooth Cover

Color	Hose I.D.		Hose O.D.		Max. W.P.*		Vac.*	MBR	Wt. Per ft	Length	Std. Pack	Pkg Code	Stock or MTO (ft)	Gates Item No.	List Price Per ft
	(in)		(mm)		(in)										
Clear	1	25.4	1.27	32.3	90	6.2	28.0	3.0	.27	100	PLT	T	Stock	7744-2101	\$3.66
Clear	1 1/4	31.8	1.53	38.9	90	6.2	28.0	4.0	.34	100	PLT	T	MTO	7744-2102	5.21
Clear	1 1/2	38.1	1.82	46.2	90	6.2	28.0	5.0	.47	100	PLT	T	Stock	7744-2103	5.60
Clear	2	50.8	2.36	59.9	70	4.8	28.0	6.0	.66	100	PLT	T	Stock	7744-2104	7.83
Clear	2 1/2	63.5	2.90	73.7	65	4.5	28.0	8.0	.95	100	PLT	T	MTO	7744-2105	10.70
Clear	3	76.2	3.44	87.4	55	3.8	28.0	9.0	1.25	100	PLT	T	Stock	7744-2106	13.46
Clear	4	101.6	4.52	114.8	50	3.4	28.0	13.0	1.94	100	PLT	T	MTO	7744-2107	19.34
Clear	5	127.0	5.65	143.5	45	3.1	28.0	21.0	3.09	100	PLT	T	MTO	7744-2108	35.28
Clear	6	152.4	6.80	172.7	45	3.1	28.0	24.0	4.56	100	PLT	T	Stock	7744-2109	40.71

NOTE: \* Working Pressure and Vacuum at +72°F (+22°C).

#### Corrugated Cover

Color	Hose I.D.		Hose O.D.		Max. W.P.*		Vac.*	MBR	Wt. Per ft	Length	Std. Pack	Pkg Code	Stock or MTO (ft)	Gates Item No.	List Price Per ft
	(in)		(mm)		(in)										
Clear	1	25.4	1.26	32.0	35	2.4	28.0	2.0	.14	100	PLT	T	Stock	7744-0000	\$4.02
Clear	1 1/4	31.8	1.61	40.9	50	3.4	28.0	3.0	.31	100	PLT	T	Stock	7744-0015	5.24
Clear	1 1/2	38.1	1.86	47.2	50	3.4	28.0	3.0	.37	100	PLT	T	Stock	7744-0008	6.15
Clear	2	50.8	2.44	62.0	40	2.8	28.0	4.0	.57	100	PLT	T	Stock	7744-0009	8.61
Clear	3	76.2	3.54	89.9	35	2.4	28.0	6.0	1.04	100	PLT	T	Stock	7744-0011	14.81
Clear	4	101.6	4.65	118.1	35	2.4	28.0	8.0	1.65	100	PLT	T	Stock	7744-0012	21.27
Clear	5	127.0	5.73	145.5	30	2.1	28.0	11.0	2.34	100	PLT	T	Stock	7744-0013	38.81
Clear	6	152.4	6.98	177.3	35	2.4	28.0	15.0	4.08	100	PLT	T	Stock	7744-0014	44.78

NOTE: \* Working Pressure and Vacuum at +72°F (+22°C).

**RECOMMENDED FOR:** Conveying water and light chemical solutions where a clear PVC hose with a white helix is desirable for heavy-duty applications.

**TEMPERATURE:** -10°F to +130°F (-23°C to +55°C) continuous service.

**CONSTRUCTION:** **Tube:** Type G (PVC). Clear. Smooth.  
**Reinforcement:** Rigid thermoplastic helix.  
**Design Factor:** 3:1

**COUPLINGS:** 1, 6, 7, 49 or 78 all sizes. Reference the Hose Coupling Section.

AGRICULTURE

AIR BREATHING

AIR DUCT

AIR AND MULTI-PURPOSE

CHEMICAL

FOOD AND BEVERAGE

MARINE AND ENGINE

MATERIAL HANDLING

MINING

OILFIELD

PETROLEUM

PRESSURE WASH AND WASHDOWN

STEAM

WATER

CLAMPS

COUPLINGS AND FERRULES

HOSE FINDER

CHEMICAL RESISTANCE TABLE

## Air Breathing Hose

### Air Master™ Diving Umbilical (1000-1125)

Formerly - 33HB



Color	Hose I.D.		Hose O.D.		Max. W.P.		Vac.	MBR	Wt. Per ft	Length	Std. Pack	Pkg Code	Stock or MTO (ft)	Gates Item No.	List Price Per ft
	(in)	(mm)	(in)	(mm)	(psi)	(Bar)	(In. Hg)	(in)	(Lbs.)	(ft)					
Black	3/8	9.5	.75	19.1	1125	77.6	30.0	4.0	.19	200-299	Reel	T	MTO	3333-0053	\$4.49
Black	3/8	9.5	.75	19.1	1125	77.6	30.0	4.0	.19	300-599	Reel	T	Stock	3333-0221	6.81
Black	3/8	9.5	.75	19.1	1125	77.6	30.0	4.0	.19	600-699	Reel	T	Stock	3333-0015	9.15
Black	3/8	9.5	.75	19.1	1125	77.6	30.0	4.0	.19	700-799	Reel	T	Stock	3333-0222	10.97
Black	3/8	9.5	.75	19.1	1125	77.6	30.0	4.0	.19	1000-Plus	Reel	T	Stock	3333-0017	11.19
Black	1/2	12.7	.94	23.9	1000	68.9	30.0	5.0	.29	50-299	Reel	T	Stock	3333-0038	5.93
Black	1/2	12.7	.94	23.9	1000	68.9	30.0	5.0	.29	300-999	Reel	T	Stock	3333-0052	15.47
Black	1/2	12.7	.94	23.9	1000	68.9	30.0	5.0	.29	1000-Plus	Reel	T	Stock	3333-0035	15.33

NOTE: Working pressure decreases as temperature increases. Pressure ratings can only be obtained with proper coupling procedures.

**RECOMMENDED FOR:** Handling mixtures of oxygen, helium, and nitrogen gases customarily used in diving applications as air breathing hose. For surface supplied air systems involved in recreational, salvage, oil rig service, and control lines.

**TEMPERATURE:** -20°F to +120°F (-40°C to +49°C) continuous service.

**CONSTRUCTION:** **Tube:** Type C (Nitrile). Black.  
**Reinforcement:** Braided, high tensile synthetic textile cord.  
**Cover:** Type A (Chloroprene). Black. All sizes are perforated.  
**Design Factor:** 4:1

**COUPLINGS:** Corrosion-resistant couplings supplied and applied by diving contractors.

**STANDARDS:** Meets BS EN250:2014. Cleanliness: Length of hose is rinsed with water for 30 seconds to 1 minute, followed by a sponge plug blown through hose to remove water. A second alcohol-soaked sponge is then blown through hose, followed by air for 30 seconds.

AGRICULTURE

AIR BREATHING

AIR DUCT

AIR AND MULTI-PURPOSE

CHEMICAL

FOOD AND BEVERAGE

MARINE AND ENGINE

MATERIAL HANDLING

MINING

OILFIELD

PETROLEUM

PRESSURE WASH AND WASHDOWN

STEAM

WATER

CLAMPS

COUPLINGS AND FERRULES

HOSE FINDER

CHEMICAL RESISTANCE TABLE

## Air Breathing Hose

### Air Master™ SCUBA 500



AGRICULTURE
AIR BREATHING
AIR DUCT
AIR AND MULTI-PURPOSE
CHEMICAL
FOOD AND BEVERAGE
MARINE AND ENGINE
MATERIAL HANDLING
MINING
OILFIELD
PETROLEUM
PRESSURE WASH AND WASHDOWN
STEAM
WATER
CLAMPS
COUPLINGS AND FERRULES
HOSE FINDER
CHEMICAL RESISTANCE TABLE

Color	Hose I.D.		Hose O.D.		Max. W.P.		Vac.	MBR	Wt. Per ft	Length	Std. Pack	Pkg Code	Stock or MTO	Gates Item No.	List Price Per ft
	(in)	(mm)	(in)	(mm)	(psi)	(Bar)									
Black	1/4	6.4	.51	13.0	500	34.5	—	2.7	.09	550	Reel	CC	MTO	4218-1002	\$6.51
Black	5/16	7.9	.56	14.2	500	34.5	—	2.8	.10	550	Reel	CC	Stock	4218-0004	6.74
Yellow	1/4	6.4	.51	13.0	500	34.5	—	2.7	.09	550	Reel	CC	Stock	4218-0009	5.84
Yellow	5/16	7.9	.56	14.2	500	34.5	—	2.8	.01	550	Reel	CC	Stock	4218-0010	6.34

NOTE: Working pressure decreases as temperature increases. Pressure ratings can only be obtained with proper coupling procedures.

**RECOMMENDED FOR:** Handling mixtures of oxygen, helium, and nitrogen gases customarily used in diving applications as air breathing hose. The kink-resistant hose is designed for extra-long wear under normal operating use. For use in SCUBA applications involving regulated supply of air to breathing mask, buoyancy compensator, and other diving accessories. Used in recreational, salvage, and oil rig service diving applications.

**TEMPERATURE:** -20°F to +120°F (-40°C to +49°C) continuous service.

**CONSTRUCTION:**  
**Tube:** Type C (Nitrile). Black.  
**Reinforcement:** Braided, high tensile synthetic textile cord.  
**Cover:** Type A (Chloroprene). Black with orange stripe. All sizes are perforated.  
 Type C2 (Modified Nitrile). Yellow. All sizes are perforated.  
**Design Factor:** 4:1

**COUPLINGS:** Corrosion-resistant couplings supplied and applied by diving contractors.

**STANDARDS:** Meets BS EN250:2014. Cleanliness: Length of hose is rinsed with water for 30 seconds to 1 minute, followed by a sponge plug blown through hose to remove water. A second alcohol-soaked sponge is then blown through hose, followed by air for 30 seconds.

## Air Breathing Hose

### Air Master™ Respirator 500



Color	Hose I.D.		Hose O.D.		Max. W.P.		Vac.	MBR	Wt. Per ft	Length	Std. Pack	Pkg Code	Stock or MTO (ft)	Gates Item No.	List Price Per ft
	(in)	(mm)	(in)	(mm)	(psi)	(Bar)									
Black	1/4	6.4	.51	13.0	500	34.5	—	3.0	.13	600	Reel	UU	MTO	3232-1001	\$3.72
Black	3/8	9.5	.70	17.8	500	34.5	—	3.0	.18	650	Reel	UU	MTO	3232-1002	6.11

**RECOMMENDED FOR:** Handling mixtures of oxygen, helium and nitrogen gases customarily used in applications as air breathing hose. The kink-resistant hose is designed for extra-long wear under normal operating use. For applications involving SCBA such as firefighting, barrier suits, mining.

**TEMPERATURE:** -20°F to +120°F (-40°C to +49°C) continuous service.

**CONSTRUCTION:** **Tube:** Type C (Nitrile). Black.  
**Reinforcement:** Braided, high tensile synthetic textile cord.  
**Cover:** Type A (Chloroprene). Black all sizes are perforated.  
**Design Factor:** 4:1

**STANDARDS:** NIOSH Air Supply Line – System Certification only. No hose specific requirement, NFPA 1901/1981.

AGRICULTURE

AIR BREATHING

AIR DUCT

AIR AND MULTI-PURPOSE

CHEMICAL

FOOD AND BEVERAGE

MARINE AND ENGINE

MATERIAL HANDLING

MINING

OILFIELD

PETROLEUM

PRESSURE WASH AND WASHDOWN

STEAM

WATER

CLAMPS

COUPLINGS AND FERRULES

HOSE FINDER

CHEMICAL RESISTANCE TABLE

## Air Duct Hose

### Air Duct (5-10) SD Formerly - 63SB



Color	Hose I.D.	Hose O.D.	Max. W.P.	Vac.	MBR	Wt. Per ft	Length	Std. Pack	Pkg Code	Stock or MTO	Gates Item No.	List Price Per ft			
	(in)	(mm)											(in)	(mm)	(psi)
Black	5/8	15.9	.81	20.6	10	.7	5.0	1.0	.12	10	Ctn	T	Stock	4663-4000	\$14.96
Black	3/4	19.1	.94	23.9	10	.7	5.0	1.0	.14	10	Ctn	T	Stock	4663-4001	16.62
Black	7/8	22.2	1.06	26.9	10	.7	5.0	1.0	.17	10	Ctn	T	Stock	4663-4002	17.36
Black	1	25.4	1.19	30.2	10	.7	5.0	1.0	.20	10	Ctn	T	Stock	4663-4003	17.85
Black	1 1/4	31.8	1.44	36.6	10	.7	5.0	1.0	.22	10	Ctn	T	Stock	4663-4004	19.59
Black	1 3/8	34.9	1.56	39.6	10	.7	5.0	1.5	.24	10	Ctn	T	Stock	4663-4005	20.18
Black	1 1/2	38.1	1.69	42.9	10	.7	5.0	1.5	.26	10	Ctn	T	Stock	4663-4006	20.60
Black	1 5/8	41.3	1.81	46.0	10	.7	5.0	2.0	.28	10	Ctn	T	Stock	4663-4007	21.48
Black	1 3/4	44.5	1.94	49.3	10	.7	5.0	2.0	.30	10	Ctn	T	Stock	4663-4008	21.99
Black	1 7/8	47.6	2.06	52.3	10	.7	5.0	2.0	.32	10	Ctn	T	Stock	4663-4009	22.68
Black	2	50.8	2.19	55.9	5	.3	3.0	2.0	.33	10	Ctn	T	Stock	4663-4010	23.34
Black	2 1/8	54.0	2.31	58.7	5	.3	3.0	2.5	.35	10	Ctn	T	Stock	4663-4011	24.23
Black	2 1/4	57.2	2.44	62.0	5	.3	3.0	2.5	.37	10	Ctn	T	Stock	4663-4012	25.23
Black	2 3/8	60.3	2.56	65.0	5	.3	3.0	2.5	.39	10	Ctn	T	Stock	4663-4013	25.85
Black	2 1/2	63.5	2.69	68.3	5	.3	3.0	2.5	.41	10	Ctn	T	Stock	4663-4014	26.57
Black	2 5/8	66.7	2.81	71.4	5	.3	3.0	2.8	.43	10	Ctn	T	Stock	4663-4015	27.65
Black	2 3/4	69.9	2.94	74.7	5	.3	3.0	2.8	.44	10	Ctn	T	Stock	4663-4016	28.70
Black	3	76.2	3.19	81.0	5	.3	3.0	3.0	.90	10	Ctn	T	Stock	4663-4017	29.93
Black	3 1/2	88.9	3.69	93.7	5	.3	3.0	3.5	.57	10	Ctn	T	Stock	4663-4018	32.51
Black	3 5/8	92.1	3.81	96.8	5	.3	3.0	4.0	.59	10	Ctn	T	Stock	4663-4019	33.95
Black	4	101.6	4.19	106.4	5	.3	3.0	4.0	1.02	10	Ctn	T	Stock	4663-4020	36.14
Black	4 1/2	114.3	4.69	119.1	5	.3	3.0	5.0	1.02	10	Ctn	T	Stock	4663-4021	59.28
Black	5	127.0	5.19	131.8	5	.3	3.0	6.0	1.09	10	Ctn	T	Stock	4663-4022	64.32
Black	5 1/2	139.7	5.69	144.5	5	.3	3.0	6.0	1.49	10	Ctn	T	Stock	4663-4023	68.76

**RECOMMENDED FOR:** Heating and ventilating applications, such as air intake for butane conversion units, air and heater ducts, defroster lines, air cleaner connections to carburetor, exhaust ducts, vent lines for trailer sewers and drains. For standard-duty applications.

**CAUTION:** Not recommended for conveying liquids.

**TEMPERATURE:** -30°F to +250°F (-34°C to +121°C) continuous service.

**CONSTRUCTION:**  
**Tube:** Type A (Chloroprene). Black. Oil-resistant.  
**Reinforcement:** Single ply of synthetic fabric with two built-in helical wires.  
**Cover:** Type A (Chloroprene impregnated fabric). Black with red stripe.  
**Design Factor:** 4:1

AGRICULTURE

AIR BREATHING

AIR DUCT

AIR AND MULTI-PURPOSE

CHEMICAL

FOOD AND BEVERAGE

MARINE AND ENGINE

MATERIAL HANDLING

MINING

OILFIELD

PETROLEUM

PRESSURE WASH AND WASHDOWN

STEAM

WATER

CLAMPS

COUPLINGS AND FERRULES

HOSE FINDER

CHEMICAL RESISTANCE TABLE

## Air Duct Hose

### Air Duct (8-20) SD Formerly - 163SB



Color	Hose I.D.		Hose O.D.		Max. W.P.		Vac.	MBR	Wt. Per ft	Length	Std. Pack	Pkg Code	Stock or MTO	Gates Item No.	List Price Per ft
	(in)	(mm)	(in)	(mm)	(psi)	(Bar)	(In. Hg)	(in)	(Lbs.)	(ft)			(ft)		
Black	3/4	19.1	1.00	25.4	20	1.4	15.0	1.0	.20	10	Ctn	T	MTO	4663-1516	\$20.78
Black	1	25.4	1.25	31.8	20	1.4	15.0	1.0	.26	10	Ctn	T	MTO	4663-1518	22.32
Black	1 1/4	31.8	1.50	38.1	20	1.4	15.0	1.0	.34	10	Ctn	T	MTO	4663-1530	24.48
Black	1 3/8	34.9	1.62	41.1	15	1.0	15.0	1.5	.44	10	Ctn	T	MTO	4663-3321	25.22
Black	1 1/2	38.1	1.75	44.5	15	1.0	15.0	1.5	.48	10	Ctn	T	MTO	4663-1540	25.74
Black	1 5/8	41.3	1.88	47.8	15	1.0	15.0	1.8	.51	10	Ctn	T	MTO	4663-1543	26.85
Black	1 3/4	44.5	2.00	50.8	15	1.0	15.0	1.8	.54	10	Ctn	T	MTO	4663-3954	27.48
Black	1 7/8	47.6	2.12	53.8	15	1.0	15.0	1.8	.58	10	Ctn	T	MTO	4663-1548	28.35
Black	2	50.8	2.25	57.2	15	1.0	15.0	2.0	.60	10	Ctn	T	MTO	4663-1550	29.16
Black	2 1/8	54.0	2.31	58.7	10	.7	15.0	2.5	.63	10	Ctn	T	MTO	4663-3461	30.27
Black	2 1/4	57.2	2.50	63.5	10	.7	15.0	2.5	.67	10	Ctn	T	MTO	4663-1556	31.53
Black	2 3/8	60.3	2.62	66.5	10	.7	15.0	2.5	.71	10	Ctn	T	MTO	4663-1560	32.30
Black	2 1/2	63.5	2.75	69.9	10	.7	15.0	2.5	.74	10	Ctn	T	MTO	4663-1565	33.21
Black	2 5/8	66.7	2.88	73.2	10	.7	15.0	3.0	.78	10	Ctn	T	MTO	4663-1615	34.56
Black	2 3/4	69.9	3.00	76.2	10	.7	15.0	7.0	.81	10	Ctn	T	MTO	4663-3456	35.87
Black	3	76.2	3.25	82.6	10	.7	7.0	10.0	.88	10	Ctn	T	MTO	4663-1570	37.41
Black	3 1/8	79.4	3.38	85.9	10	.7	7.0	10.0	.92	10	Ctn	T	MTO	4663-1569	38.72
Black	3 1/2	88.9	3.75	95.3	10	.7	7.0	10.0	1.01	10	Ctn	T	MTO	4663-1575	40.64
Black	4	101.6	4.25	108.0	10	.7	7.0	12.0	1.15	10	Ctn	T	MTO	4663-1580	45.17
Black	4 1/2	114.3	4.75	120.7	10	.7	7.0	12.0	1.25	10	Ctn	T	MTO	4663-1589	74.10
Black	5	127.0	5.25	133.4	10	.7	6.0	12.0	1.40	10	Ctn	T	MTO	4663-1595	80.40
Black	5 1/2	139.7	5.75	146.1	10	.7	6.0	12.0	1.52	10	Ctn	T	MTO	4663-3454	85.95
Black	6	152.4	6.25	158.8	8	.6	6.0	15.0	1.70	10	Ctn	T	MTO	4663-1599	91.79

**RECOMMENDED FOR:** Heavy-duty heating and ventilating applications, such as air intake for butane conversion units, air and heater ducts, defroster lines, air cleaner connections to carburetor, exhaust ducts, vent lines for trailer sewers and drains.

**CAUTION:** Not recommended for conveying liquids.

**TEMPERATURE:** -30°F to +250°F (-34°C to +121°C) continuous service.

**CONSTRUCTION:** **Tube:** Type A (Chloroprene). Black. Oil and heat-resistant.  
**Reinforcement:** Single ply of synthetic fabric with two built-in helical wires.  
**Cover:** Type A (Chloroprene). Black with red stripe. Oil and heat-resistant.  
**Design Factor:** 4:1

AGRICULTURE

AIR BREATHING

AIR DUCT

AIR AND MULTI-PURPOSE

CHEMICAL

FOOD AND BEVERAGE

MARINE AND ENGINE

MATERIAL HANDLING

MINING

OILFIELD

PETROLEUM

PRESSURE WASH AND WASHDOWN

STEAM

WATER

CLAMPS

COUPLINGS AND FERRULES

HOSE FINDER

CHEMICAL RESISTANCE TABLE

## Air and Multi-Purpose Hose

### Plant Master® XTreme™ 325 Braid

Formerly - 19B, 119B



AGRICULTURE
AIR BREATHING
AIR DUCT
<b>AIR AND MULTI-PURPOSE</b>
CHEMICAL
FOOD AND BEVERAGE
MARINE AND ENGINE
MATERIAL HANDLING
MINING
OILFIELD
PETROLEUM
PRESSURE WASH AND WASHDOWN
STEAM
WATER
CLAMPS
COUPLINGS AND FERRULES
HOSE FINDER
CHEMICAL RESISTANCE TABLE

Color	Hose I.D.	Hose O.D.	Max. W.P.	Vac.	MBR	Wt. Per ft	Length	Std. Pack	Pkg Code	Stock or MTO	Gates Item No.	List Price Per ft			
	(in)	(mm)											(in)	(mm)	(psi)
Black	1/4	6.4	.50	12.7	325	22.4	30.0	3.0	.09	625	Reel	BB	Stock	3219-2930	\$3.48
Black	5/16	7.9	.62	15.7	325	22.4	30.0	3.0	.13	625	Reel	BB	Stock	3219-2932	3.72
Black	3/8	9.5	.69	17.5	325	22.4	30.0	3.0	.15	625	Reel	BB	Stock	3219-2933	3.90
Black	1/2	12.7	.84	21.3	325	22.4	25.0	5.0	.20	625	Reel	BB	MTO	3219-2935	5.43
Black	5/8	15.9	.94	23.9	325	22.4	20.0	6.0	.24	525	Reel	BB	MTO	3219-2937	6.27
Black	3/4	19.1	1.09	27.7	325	22.4	20.0	6.0	.29	525	Reel	BB	Stock	3219-2938	7.76
Black	1	25.4	1.38	35.1	325	22.4	10.0	8.0	.46	525	Reel	BB	Stock	3219-2940	9.33
Red	1/4	6.4	.50	12.7	325	22.4	30.0	3.0	.09	625	Reel	BB	Stock	3219-2902	3.65
Red	5/16	7.9	.62	15.7	325	22.4	30.0	3.0	.13	625	Reel	BB	MTO	3219-2904	3.90
Red	3/8	9.5	.69	17.5	325	22.4	30.0	3.0	.15	625	Reel	BB	Stock	3219-2906	4.14
Red	1/2	12.7	.84	21.3	325	22.4	25.0	5.0	.20	625	Reel	BB	Stock	3219-2908	5.79
Red	5/8	15.9	.94	23.9	325	22.4	20.0	6.0	.24	525	Reel	BB	Stock	3219-2910	6.59
Red	3/4	19.1	1.09	27.7	325	22.4	20.0	6.0	.29	525	Reel	BB	Stock	3219-2912	8.10
Red	1	25.4	1.38	35.1	325	22.4	10.0	8.0	.41	525	Reel	BB	Stock	3219-2914	9.89

**RECOMMENDED FOR:** Applications requiring a premium grade braided hose, with excellent flexibility and maximum resistance to air, water, petroleum oils, gasoline, kerosene and fuel oil (to +120°F) and lubricating oils (to +212°F). Excellent weather and ozone resistance.

**CAUTION:** Not recommended for constant contact with fuels. Not recommended for Bio-Diesel fuels.

**TEMPERATURE:** -40°F to +212°F (-40°C to +100°C) continuous service.

**CONSTRUCTION:**  
**Tube:** Type C (Nitrile). Black.  
**Reinforcement:** Braided, high tensile synthetic textile cord.  
**Cover:** Type A (Chloroprene). Black.  
 Type C2 (Modified Nitrile). Red.  
**Design Factor:** 4:1

**COUPLINGS:** 19 (up through 1/2" only), 3 or 4, (up through 1/2" with 20 brass ferrules, up through 1" with bands), 1, 14, or 15 (all sizes), 72 Gates Power Crimp® or 75 Gates GLX®. Reference the Hose Coupling Section.

**STANDARDS:**  
**Tube:** ARPM (Class A) High oil-resistance.  
**Cover:** ARPM (Class B) Medium oil-resistance.



## Air and Multi-Purpose Hose

### Plant Master® XTreme™ 501 AR Formerly - Terminator®



Color	Hose I.D.		Hose O.D.		Max. W.P.		Vac.	MBR	Wt. Per ft	Length	Std. Pack	Pkg Code	Stock or MTO	Gates Item No.	List Price Per ft
	(in)		(mm)												
Yellow	1/4	6.4	.57	14.5	501	34.5	30.0	3.0	.15	500	Reel	XX	Stock	3202-0001	\$3.59
Yellow	1/4	6.4	.57	14.5	501	34.5	30.0	3.0	.12	500	Reel	T	Stock	3202-0301	3.95
Yellow	3/8	9.5	.75	19.1	501	34.5	25.0	3.0	.19	500	Reel	XX	Stock	3202-0006	4.44
Yellow	3/8	9.5	.75	19.1	501	34.5	25.0	3.0	.20	500	Reel	T	Stock	3202-0306	4.88
Yellow	1/2	12.7	.89	22.6	501	34.5	25.0	5.0	.25	500	Reel	XX	Stock	3202-0011	6.23
Yellow	1/2	12.7	.89	22.6	501	34.5	25.0	5.0	.27	500	Reel	T	Stock	3202-0311	6.85
Yellow	3/4	19.1	1.22	31.0	501	34.5	15.0	6.0	.45	500	Reel	XX	Stock	3202-0016	8.34
Yellow	3/4	19.1	1.22	31.0	501	34.5	15.0	6.0	.45	500	Reel	T	Stock	3202-0316	9.17
Yellow	1	25.4	1.51	38.4	501	34.5	10.0	8.0	.57	400	Reel	XX	Stock	3202-0021	12.39
Yellow	1 1/4	31.8	1.78	45.2	501	34.5	10.0	10.0	.73	300	Reel	XX	Stock	3202-0027	17.13
Yellow	1 1/2	38.1	2.09	53.1	501	34.5	10.0	12.0	.96	100	PLT	T	Stock	3202-0029	23.94
Yellow	1 1/2	38.1	2.09	53.1	501	34.5	10.0	12.0	.96	200	PLT	T	MTO	3202-0317	23.94
Yellow	2	50.8	2.64	67.1	501	34.5	10.0	14.0	1.35	100	PLT	T	Stock	3202-0032	26.15
Yellow	2	50.8	2.64	67.1	501	34.5	10.0	14.0	1.35	200	PLT	T	MTO	3202-0033	26.15

NOTE: Pkg Code T=One piece continuous length reel. Pkg Code XX=Two piece reel, 50 ft increments, no length less than 50 ft.

**RECOMMENDED FOR:** Applications requiring a premium-quality, multi-purpose hose with superior abrasion resistance for air, oil and some chemical applications. Excellent durability for extra-long life in these applications: mining, air drill, construction, poultry plants and other severe service. Good weather and ozone resistance.

**CAUTION:** Due to 501 AR PSI working pressure, care should be taken to properly select couplings to match. Hose assembly working pressure is the working pressure of the lowest rated component.

**TEMPERATURE:** -40°F to +212°F (-40°C to +100°C) continuous service.

**CONSTRUCTION:** **Tube:** Type C (Nitrile). Black.  
**Reinforcement:** Synthetic, high tensile textile cord.  
**Cover:** Type C4 (Carboxylated Nitrile). Yellow.  
**Design Factor:** 4:1

**COUPLINGS:** 19 (up through 1/2" only), 1, 3 or 4, (up through 1/2" with 20 brass ferrules, up through 1" with bands), 15, 71, 72 Gates Power Crimp®, 73 (up to 250 psi), 74 Gates MegaCrimp®, 75 Gates GLX® or 80 Gates GSP (1 1/2" or 2" only). Reference the Hose Coupling Section.

**STANDARDS:** All sizes except 1 1/2" and 2" are non-conductive (>1 Megohm/in.).  
Meets MSHA Flame-resistant.  
Storage and use may adversely affect electrical resistance.  
**Tube:** ARPM (Class A) High oil-resistance.  
**Cover:** ARPM (Class A) High oil-resistance.

AGRICULTURE

AIR BREATHING

AIR DUCT

AIR AND MULTI-PURPOSE

CHEMICAL

FOOD AND BEVERAGE

MARINE AND ENGINE

MATERIAL HANDLING

MINING

OILFIELD

PETROLEUM

PRESSURE WASH AND WASHDOWN

STEAM

WATER

CLAMPS

COUPLINGS AND FERRULES

HOSE FINDER

CHEMICAL RESISTANCE TABLE

## Air and Multi-Purpose Hose

### Plant Master® XTreme™ 300 Lock-On Braid

Formerly - LOL



AGRICULTURE
AIR BREATHING
AIR DUCT
AIR AND MULTI-PURPOSE
CHEMICAL
FOOD AND BEVERAGE
MARINE AND ENGINE
MATERIAL HANDLING
MINING
OILFIELD
PETROLEUM
PRESSURE WASH AND WASHDOWN
STEAM
WATER
CLAMPS
COUPLINGS AND FERRULES
HOSE FINDER
CHEMICAL RESISTANCE TABLE

Color	Hose I.D.	Hose O.D.	Max. W.P.	Vac.	MBR	Wt. Per ft	Length	Std. Pack	Pkg Code	Stock or MTO	Gates Item No.	List Price Per ft			
	(in)	(mm)	(psi)	(in. Hg)	(in)	(Lbs.)							(ft)		
Black	1/4	6.4	.47	11.9	300	20.7	27.9	3.0	.09	300	Reel	M	Stock	3201-1100	\$2.34
Black	3/8	9.5	.63	16.0	300	20.7	27.9	3.0	.11	300	Reel	M	Stock	3201-1101	2.94
Black	1/2	12.7	.77	19.6	300	20.7	27.9	5.0	.15	300	Reel	M	Stock	3201-1102	3.44
Black	5/8	15.9	.94	23.9	300	20.7	27.9	6.0	.20	250	Reel	M	Stock	3201-1103	4.58
Black	3/4	19.1	1.06	26.9	300	20.7	15.0	7.0	.24	225	Reel	M	Stock	3201-1104	5.72
Blue	1/4	6.4	.47	11.9	300	20.7	27.9	3.0	.09	300	Reel	M	Stock	3201-1105	2.34
Blue	3/8	9.5	.63	16.0	300	20.7	27.9	3.0	.11	300	Reel	M	Stock	3201-1106	2.94
Blue	1/2	12.7	.77	19.6	300	20.7	27.9	5.0	.15	300	Reel	M	Stock	3201-1107	3.44
Blue	5/8	15.9	.94	23.9	300	20.7	27.9	6.0	.20	250	Reel	M	Stock	3201-1108	4.58
Blue	3/4	19.1	1.06	26.9	300	20.7	15.0	7.0	.24	225	Reel	M	Stock	3201-1109	5.72
Gray	1/4	6.4	.47	11.9	300	20.7	27.9	3.0	.09	300	Reel	M	Stock	3201-1125	2.34
Gray	3/8	9.5	.63	16.0	300	20.7	27.9	3.0	.11	300	Reel	M	Stock	3201-1126	2.94
Gray	1/2	12.7	.77	19.6	300	20.7	27.9	5.0	.15	300	Reel	M	Stock	3201-1127	3.44
Gray	5/8	15.9	.94	23.9	300	20.7	27.9	6.0	.20	250	Reel	M	Stock	3201-1128	4.58
Gray	3/4	19.1	1.06	26.9	300	20.7	15.0	7.0	.24	225	Reel	M	Stock	3201-1129	5.72
Green	1/4	6.4	.47	11.9	300	20.7	27.9	3.0	.09	300	Reel	M	Stock	3201-1120	2.34
Green	3/8	9.5	.63	16.0	300	20.7	27.9	3.0	.11	300	Reel	M	Stock	3201-1121	2.94
Green	1/2	12.7	.77	19.6	300	20.7	27.9	5.0	.15	300	Reel	M	Stock	3201-1122	3.44
Green	5/8	15.9	.94	23.9	300	20.7	27.9	6.0	.20	250	Reel	M	MTO	3201-1123	4.58
Green	3/4	19.1	1.06	26.9	300	20.7	15.0	7.0	.24	225	Reel	M	Stock	3201-1124	5.72
Red	1/4	6.4	.47	11.9	300	20.7	27.9	3.0	.09	300	Reel	M	Stock	3201-1110	2.34
Red	3/8	9.5	.63	16.0	300	20.7	27.9	3.0	.11	300	Reel	M	Stock	3201-1111	2.94
Red	1/2	12.7	.77	19.6	300	20.7	27.9	5.0	.15	300	Reel	M	Stock	3201-1112	3.44
Red	5/8	15.9	.94	23.9	300	20.7	27.9	6.0	.20	250	Reel	M	MTO	3201-1113	4.58
Red	3/4	19.1	1.06	26.9	300	20.7	15.0	7.0	.24	225	Reel	M	Stock	3201-1114	5.72
Yellow	1/4	6.4	.47	11.9	300	20.7	27.9	3.0	.09	300	Reel	M	Stock	3201-1115	2.34
Yellow	3/8	9.5	.63	16.0	300	20.7	27.9	3.0	.11	300	Reel	M	Stock	3201-1116	2.94
Yellow	1/2	12.7	.77	19.6	300	20.7	27.9	5.0	.15	300	Reel	M	Stock	3201-1117	3.44
Yellow	5/8	15.9	.94	23.9	300	20.7	27.9	6.0	.20	250	Reel	M	Stock	3201-1118	4.58
Yellow	3/4	19.1	1.06	26.9	300	20.7	15.0	7.0	.24	225	Reel	M	Stock	3201-1119	5.72

**RECOMMENDED FOR:** Petroleum-based hydraulic oils, water, glycol anti-freeze solutions, hot lubricating oils, and air.

**CAUTION:** Hose and couplings are not recommended for pressure surge applications or critical applications, such as permanent piping in residential or commercial buildings. Not recommended for gasoline or diesel fuels.

**TEMPERATURE:** -40°F to +212°F (-40°C to +100°C) normal service. For air: +160°F (+71°C) only. For water emulsion, see Gates Hydraulic Hose Catalog #35093.

**CONSTRUCTION:** **Tube:** Type C (Nitrile). Black.  
**Reinforcement:** Braided, high tensile synthetic textile cord.  
**Cover:** Type C2 (Modified Nitrile).  
**Design Factor:** 4:1

**COUPLINGS:** 75 Gates GLX®, 83 Gates Lock-On Couplings. NOTE: Do not use clamps with Lock-On fittings. Reference the Hose Coupling Section.

**STANDARDS:** Black cover meets MSHA Flame-resistant.  
**Tube:** ARPM (Class A) High oil-resistance.  
**Cover:** ARPM (Class B) Medium oil-resistance. Flame-resistant.

## Air and Multi-Purpose Hose

### Plant Master® XTreme™ (250-315)

Formerly - Premo Flex®



Color	Hose I.D.		Hose O.D.		Max. W.P.		Vac.	MBR	Wt. Per ft	Length	Std. Pack	Pkg Code	Stock or MTO (ft)	Gates Item No.	List Price Per ft
	(in)		(mm)												
Red	3/16	4.8	.45	11.4	250	17.2	30.0	2.0	.07	500	Reel	XX	MTO	3205-0010	\$1.91
Red	1/4	6.4	.50	12.7	250	17.2	30.0	2.0	.09	500	Reel	XX	Stock	3205-0015	2.16
Red	1/4	6.4	.50	12.7	250	17.2	30.0	2.0	.09	500	Reel	T	Stock	3205-0215	2.38
Red	1/4	6.4	.57	14.5	315	21.7	30.0	2.0	.12	500	Reel	XX	Stock	3205-0016	3.06
Red	1/4	6.4	.57	14.5	315	21.7	30.0	2.0	.12	500	Reel	T	MTO	3205-0216	3.37
Red	5/16	7.9	.56	14.2	250	17.2	30.0	2.0	.11	500	Reel	XX	MTO	3205-0020	2.33
Red	5/16	7.9	.67	17.0	315	21.7	30.0	2.0	.16	500	Reel	XX	MTO	3205-0021	3.68
Red	3/8	9.5	.66	16.8	250	17.2	30.0	3.0	.17	500	Reel	XX	Stock	3205-0025	2.91
Red	3/8	9.5	.66	16.8	250	17.2	30.0	3.0	.14	500	Reel	T	Stock	3205-0225	3.20
Red	3/8	9.5	.73	18.5	315	21.7	30.0	3.0	.18	500	Reel	XX	Stock	3205-0026	4.10
Red	3/8	9.5	.73	18.5	315	21.7	30.0	3.0	.18	500	Reel	T	Stock	3205-0226	4.51
Red	1/2	12.7	.85	21.6	250	17.2	25.0	4.0	.22	500	Reel	XX	Stock	3205-0030	3.89
Red	1/2	12.7	.85	21.6	250	17.2	25.0	4.0	.24	500	Reel	T	Stock	3205-0230	4.28
Red	1/2	12.7	.88	22.4	315	21.7	25.0	4.0	.28	500	Reel	XX	Stock	3205-0031	5.36
Red	1/2	12.7	.88	22.4	315	21.7	25.0	4.0	.24	500	Reel	T	Stock	3205-0231	5.90
Red	5/8	15.9	.98	24.9	250	17.2	20.0	5.0	.27	500	Reel	XX	MTO	3205-0035	5.21
Red	5/8	15.9	.98	24.9	315	21.7	20.0	5.0	.26	500	Reel	XX	Stock	3205-0036	6.26
Red	5/8	15.9	.98	24.9	250	17.2	20.0	5.0	.27	500	Reel	T	Stock	3205-0235	5.73
Red	5/8	15.9	.98	24.9	315	21.7	20.0	5.0	.30	500	Reel	T	Stock	3205-0236	6.89
Red	3/4	19.1	1.15	29.2	250	17.2	20.0	5.0	.36	50	Bulk	200	MTO	3205-5040	6.39
Red	3/4	19.1	1.15	29.2	250	17.2	20.0	5.0	.36	500	Reel	XX	Stock	3205-0040	6.39
Red	3/4	19.1	1.15	29.2	250	17.2	20.0	5.0	.41	500	Reel	T	Stock	3205-0240	7.03
Red	3/4	19.1	1.19	30.2	315	21.7	20.0	5.0	.40	500	Reel	XX	Stock	3205-0041	7.71
Red	3/4	19.1	1.19	30.2	315	21.7	20.0	5.0	.39	500	Reel	T	Stock	3205-0241	8.48
Red	1	25.4	1.47	37.3	250	17.2	10.0	8.0	.54	400	Reel	XX	Stock	3205-0046	8.48
Red	1 1/4	31.8	1.75	44.5	250	17.2	10.0	10.0	.67	300	Reel	XX	Stock	3205-0049	13.68
Red	1 1/2	38.1	2.00	50.8	250	17.2	10.0	12.0	.85	200	Reel	XX	Stock	3205-0055	16.40

NOTE: Pkg Code T=One piece continuous length reel. Pkg Code XX=Two piece reel, 50 ft increments, no length less than 50 ft.

**RECOMMENDED FOR:** Applications requiring a premium grade spiral hose with excellent flexibility and maximum resistance to air, water, petroleum oils and lubricating oils, (to +212°F). Recommended for gasoline, kerosene and fuel oil transfer only (to +120°F). Excellent weather and ozone resistance.

**TEMPERATURE:** -40°F to +212°F (-40°C to +100°C) continuous service.

**CONSTRUCTION:** **Tube:** Type C (Nitrile). Black.  
**Reinforcement:** Synthetic, high tensile textile cord.  
**Cover:** Type C2 (Modified Nitrile). Red.  
**Design Factor:** 4:1

**COUPLINGS:** 19 (up through 1/2" only), 3 or 4, (up through 1/2" with 20 ferrules, up through 1" with bands), 1, 8, 14, 15, 72 Gates Power Crimp® or 75 Gates GLX®. Reference the Hose Coupling Section.

**STANDARDS:** Non-conductive (>1 Megohm/in.).  
 Storage and use may adversely affect electrical resistance.  
**Tube:** ARPM (Class A) High oil-resistance.  
**Cover:** ARPM (Class B) Medium oil-resistance.

AGRICULTURE

AIR BREATHING

AIR DUCT

AIR AND MULTI-PURPOSE

CHEMICAL

FOOD AND BEVERAGE

MARINE AND ENGINE

MATERIAL HANDLING

MINING

OILFIELD

PETROLEUM

PRESSURE WASH AND WASHDOWN

STEAM

WATER

CLAMPS

COUPLINGS AND FERRULES

HOSE FINDER

CHEMICAL RESISTANCE TABLE

## Air and Multi-Purpose Hose

### Plant Master® XTreme™ 300 AR

Formerly - Premo Flex® AR



AGRICULTURE
AIR BREATHING
AIR DUCT
AIR AND MULTI-PURPOSE
CHEMICAL
FOOD AND BEVERAGE
MARINE AND ENGINE
MATERIAL HANDLING
MINING
OILFIELD
PETROLEUM
PRESSURE WASH AND WASHDOWN
STEAM
WATER
CLAMPS
COUPLINGS AND FERRULES
HOSE FINDER
CHEMICAL RESISTANCE TABLE

Color	Hose I.D.		Hose O.D.		Max. W.P.		Vac.	MBR	Wt. Per ft	Length	Std. Pack	Pkg Code	Stock or MTO (ft)	Gates Item No.	List Price Per ft
	(in)		(mm)		(in)										
Black	1/4	6.4	.53	13.5	300	20.7	30.0	2.0	.11	500	Reel	XX	Stock	3205-0503	\$3.57
Black	3/8	9.5	9.50	17.8	300	20.7	30.0	3.0	.16	500	Reel	XX	Stock	3205-0504	4.51
Black	1/2	12.7	.84	21.3	300	20.7	25.0	4.0	.21	500	Reel	XX	Stock	3205-0505	5.90
Black	3/4	19.1	1.19	30.2	300	20.7	20.0	5.0	.40	500	Reel	XX	Stock	3205-0506	8.48
Black	1	25.4	1.50	38.1	300	20.7	10.0	8.0	.59	400	Reel	XX	Stock	3205-0507	9.75
Red	1/4	6.4	.53	13.5	300	20.7	30.0	2.0	.10	500	Reel	XX	Stock	3205-0401	3.37
Red	1/4	6.4	.53	13.5	300	20.7	30.0	2.0	.10	500	Reel	T	Stock	3205-0406	3.70
Red	3/8	9.5	.70	17.8	300	20.7	30.0	3.0	.16	500	Reel	XX	Stock	3205-0402	4.51
Red	3/8	9.5	.70	17.8	300	20.7	30.0	3.0	.16	500	Reel	T	Stock	3205-0407	4.96
Red	1/2	12.7	.84	21.3	300	20.7	25.0	4.0	.22	500	Reel	XX	Stock	3205-0403	5.90
Red	1/2	12.7	.84	21.3	300	20.7	25.0	4.0	.22	500	Reel	T	Stock	3205-0408	6.49
Red	3/4	19.1	1.19	30.2	300	20.7	20.0	5.0	.47	500	Reel	XX	Stock	3205-0404	8.48
Red	3/4	19.1	1.19	30.2	300	20.7	20.0	5.0	.40	500	Reel	T	Stock	3205-0409	9.33
Red	1	25.4	1.50	38.1	300	20.7	10.0	8.0	.59	400	Reel	XX	Stock	3205-0405	9.75

NOTE: Pkg Code T=One piece continuous length reel. Pkg Code XX=Two piece reel, 50 ft increments, no length less than 50 ft.

**RECOMMENDED FOR:** Applications requiring a premium grade spiral hose with superior abrasion resistance, excellent flexibility and maximum resistance to air, water, petroleum oils and lubricating oils (to +212°F). Recommended for gasoline, kerosene, and fuel oil transfer only to +120°F. Good weather and ozone resistance.

**TEMPERATURE:** -40°F to +212°F (-40°C to +100°C) continuous service.

**CONSTRUCTION:**  
**Tube:** Type C (Nitrile). Black.  
**Reinforcement:** Synthetic, high tensile textile cord.  
**Cover:** Type C4 (Carboxylated Nitrile). Black or Red.  
**Design Factor:** 4:1

**COUPLINGS:** 19 (up through 1/2" only), 1, 3 or 4, (up through 1/2" with 20 ferrules, up through 1" with bands), 8, 14, 15, 74 Gates MegaCrimp®, 75 Gates GLX® or 82 Gates SS. Reference the Hose Coupling Section.

**STANDARDS:** Meets MSHA Flame-resistant.  
 Non-conductive (>1 Megohm/in.).  
 Storage and use may adversely affect electrical resistance.  
**Tube:** ARPM (Class A) High oil-resistance.  
**Cover:** ARPM (Class A) High oil-resistance.

## Air and Multi-Purpose Hose

### Plant Master® Plus 300 Lock-On

Formerly - Python® Plus



Color	Hose I.D.		Hose O.D.		Max. W.P.		Vac.	MBR	Wt. Per ft	Length	Std. Pack	Pkg Code	Stock or MTO	Gates Item No.	List Price Per ft
	(in)		(mm)		(in)										
Black	1/4	6.4	.54	13.7	300	20.7	30.0	3.0	.11	500	Reel	XX	Stock	3222-0183	\$2.22
Black	3/8	9.5	.68	17.3	300	20.7	30.0	3.0	.15	500	Reel	XX	Stock	3222-0184	2.81
Black	1/2	12.7	.81	20.6	300	20.7	30.0	5.0	.18	500	Reel	XX	Stock	3222-0185	3.27
Blue	1/4	6.4	.54	13.7	300	20.7	30.0	3.0	.11	500	Reel	XX	Stock	3222-0143	2.22
Blue	3/8	9.5	.68	17.3	300	20.7	30.0	3.0	.15	500	Reel	XX	Stock	3222-0144	2.81
Blue	1/2	12.7	.81	20.6	300	20.7	30.0	5.0	.18	500	Reel	XX	Stock	3222-0145	3.27
Gray	1/4	6.4	.54	13.7	300	20.7	30.0	3.0	.11	500	Reel	XX	Stock	3222-0283	2.22
Gray	3/8	9.5	.68	17.3	300	20.7	30.0	3.0	.15	500	Reel	XX	Stock	3222-0284	2.81
Gray	1/2	12.7	.81	20.6	300	20.7	30.0	5.0	.18	500	Reel	XX	Stock	3222-0285	3.27
Green	1/4	6.4	.54	13.7	300	20.7	30.0	3.0	.11	500	Reel	XX	MTO	3222-0233	2.22
Green	3/8	9.5	.68	17.3	300	20.7	30.0	3.0	.15	500	Reel	XX	Stock	3222-0234	2.81
Green	1/2	12.7	.81	20.6	300	20.7	30.0	5.0	.18	500	Reel	XX	Stock	3222-0235	3.27
Red	1/4	6.4	.54	13.7	300	20.7	30.0	3.0	.11	500	Reel	XX	MTO	3222-0333	2.22
Red	3/8	9.5	.68	17.3	300	20.7	30.0	3.0	.15	500	Reel	XX	Stock	3222-0334	2.81
Red	1/2	12.7	.81	20.6	300	20.7	30.0	5.0	.18	500	Reel	XX	Stock	3222-0335	3.27
Yellow	1/4	6.4	.54	13.7	300	20.7	30.0	3.0	.11	500	Reel	XX	MTO	3222-0083	2.22
Yellow	3/8	9.5	.68	17.3	300	20.7	30.0	3.0	.15	500	Reel	XX	Stock	3222-0084	2.81
Yellow	1/2	12.7	.81	20.6	300	20.7	30.0	5.0	.18	500	Reel	XX	Stock	3222-0085	3.27

**RECOMMENDED FOR:** Air, water, oils, antifreeze solutions and applications where Lock-On fittings are used.

**CAUTION:** Hose is not recommended for applications where vibrations or pressure surges exist. Do not use oil for Lock-On fitting insertion purposes. Not recommended for gasoline or diesel fuels.

**TEMPERATURE:** -20°F to +212°F (-29°C to +100°C) normal service. For air: +160°F (+71°C) only. For water emulsion, see Gates Hydraulic Hose Catalog #35093.

**CONSTRUCTION:**  
**Tube:** Type C (Nitrile). Black.  
**Reinforcement:** Aramid tensile cord.  
**Cover:** Type A (Chloroprene). Black.  
 Type C2 (Modified Nitrile). Blue, red, yellow, green or gray.  
**Design Factor:** 4:1

**COUPLINGS:** 75 Gates GLX®, 83 Gates Lock-On Couplings. NOTE: Do not use clamps with Lock-On fittings. Reference the Hose Coupling Section.

**STANDARDS:** Non-conductive (>1 Megohm/in.).  
 Storage and use may adversely affect electrical resistance.  
**Tube:** ARPM (Class A) High oil-resistance.  
**Cover:** ARPM (Class B) Medium oil-resistance.

AGRICULTURE

AIR BREATHING

AIR DUCT

AIR AND MULTI-PURPOSE

CHEMICAL

FOOD AND BEVERAGE

MARINE AND ENGINE

MATERIAL HANDLING

MINING

OILFIELD

PETROLEUM

PRESSURE WASH AND WASHDOWN

STEAM

WATER

CLAMPS

COUPLINGS AND FERRULES

HOSE FINDER

CHEMICAL RESISTANCE TABLE

## Air and Multi-Purpose Hose

### Plant Master® Plus (200-300)

Formerly - Duro Flex®



AGRICULTURE
AIR BREATHING
AIR DUCT
<b>AIR AND MULTI-PURPOSE</b>
CHEMICAL
FOOD AND BEVERAGE
MARINE AND ENGINE
MATERIAL HANDLING
MINING
OILFIELD
PETROLEUM
PRESSURE WASH AND WASHDOWN
STEAM
WATER
CLAMPS
COUPLINGS AND FERRULES
HOSE FINDER
CHEMICAL RESISTANCE TABLE

Color	Hose I.D.	Hose O.D.	Max. W.P.	Vac.	MBR	Wt. Per ft	Length	Std. Pack	Pkg Code	Stock or MTO	Gates Item No.	List Price Per ft			
	(in)	(mm)											(in)	(mm)	(psi)
Black	2	50.8	2.56	65.0	200	13.8	4.0	16.5	1.32	100	Ctn	T	Stock	3206-3968	\$20.67
Red	1/4	6.4	.50	12.7	250	17.2	30.0	2.0	.10	500	Reel	XX	Stock	3200-0002	1.85
Red	1/4	6.4	.50	12.7	250	17.2	30.0	2.0	.09	500	Reel	T	Stock	3200-0202	2.04
Red	1/4	6.4	.57	14.5	300	20.7	30.0	2.0	.12	500	Reel	XX	Stock	3200-0003	2.00
Red	3/8	9.5	.66	16.8	250	17.2	30.0	3.0	.14	500	Reel	XX	Stock	3200-0006	2.34
Red	3/8	9.5	.66	16.8	250	17.2	30.0	3.0	.14	500	Reel	T	Stock	3200-0206	2.57
Red	3/8	9.5	.73	18.5	300	20.7	30.0	3.0	.18	500	Reel	XX	Stock	3200-0007	2.60
Red	3/8	9.5	.73	18.5	300	20.7	30.0	3.0	.18	500	Reel	T	Stock	3200-0207	2.86
Red	1/2	12.7	.81	20.6	250	17.2	25.0	4.0	.19	500	Reel	XX	Stock	3200-0008	2.78
Red	1/2	12.7	.81	20.6	250	17.2	25.0	4.0	.25	500	Reel	T	Stock	3200-0208	3.06
Red	1/2	12.7	.84	21.3	300	20.7	25.0	4.0	.25	500	Reel	XX	Stock	3200-0009	3.53
Red	1/2	12.7	.84	21.3	300	20.7	25.0	4.0	.22	500	Reel	T	Stock	3200-0209	3.88
Red	5/8	15.9	.98	24.9	250	17.2	20.0	5.0	.27	500	Reel	XX	MTO	3200-0010	3.86
Red	5/8	15.9	.98	24.9	300	20.7	20.0	5.0	.30	500	Reel	XX	Stock	3200-0011	4.52
Red	5/8	15.9	.98	24.9	250	17.2	20.0	5.0	.27	500	Reel	T	Stock	3200-0210	4.25
Red	3/4	19.1	1.15	29.2	250	17.2	20.0	5.0	.36	50	Bulk	200	MTO	3200-5012	3.99
Red	3/4	19.1	1.15	29.2	250	17.2	20.0	5.0	.36	500	Reel	XX	Stock	3200-0012	3.99
Red	3/4	19.1	1.15	29.2	300	20.7	20.0	5.0	.36	500	Reel	XX	Stock	3200-0013	4.83
Red	3/4	19.1	1.15	29.2	250	17.2	20.0	5.0	.35	500	Reel	T	Stock	3200-0212	4.39
Red	3/4	19.1	1.15	29.2	300	20.7	20.0	5.0	.36	500	Reel	T	Stock	3200-0213	5.31
Red	1	25.4	1.47	37.3	250	17.2	10.0	8.0	.54	400	Reel	XX	Stock	3200-0014	5.87
Red	1 1/4	31.8	1.73	43.9	250	17.2	10.0	10.0	.67	200	Reel	XX	Stock	3200-0015	11.58
Red	1 3/8	34.9	1.88	47.8	250	17.2	10.0	11.0	.86	250	Reel	XX	MTO	3200-0237	14.35
Red	1 1/2	38.1	1.98	50.3	250	17.2	10.0	12.0	.79	200	Reel	XX	Stock	3200-0016	12.08
Red	2	50.8	2.56	65.0	200	13.8	4.0	16.5	1.28	100	Ctn	T	Stock	3200-1279	20.67

NOTE: Pkg Code T=One piece continuous length reel. Pkg Code XX=Two piece reel, 50 ft increments, no length less than 50 ft.

**RECOMMENDED FOR:** Applications requiring maximum flexibility and good resistance to air, water and heat. For SAE oils intermittent contact only.

**TEMPERATURE:** -40°F to +200°F (-40°C to +93°C) continuous service.

**CONSTRUCTION:** **Tube:** Type B1 (Specially compounded elastomer). Black.

**Reinforcement:** Synthetic, high tensile textile cord.

**Cover:** Type D3 (Specially compounded elastomer). For 2" Black only.

Type P (EPDM). Red. All sizes through 1/2" have perforated cover.

**Design Factor:** 3:1

**COUPLINGS:** 19 (up through 1/2" only), 1, 3 or 4, (up through 1/2" with 20 brass ferrules, up through 1" with bands), 72 Gates Power Crimp® or 75 Gates GLX®. Reference the Hose Coupling Section.

**STANDARDS:** **Tube:** ARPM (Class B) Medium oil-resistance.

**Cover:** ARPM (Class C) Limited oil-resistance.

## Air and Multi-Purpose Hose

### Plant Master® 300 Formerly - Adapta Flex™



Color	Hose I.D.	Hose O.D.	Max. W.P.	Vac.	MBR	Wt. Per ft	Length	Std. Pack	Pkg Code	Stock or MTO	Gates Item No.	List Price Per ft			
	(in)	(mm)	(psi)	(in. Hg)	(in)	(Lbs.)	(ft)			(ft)					
Black	3/4	19.1	1.15	29.2	300	20.7	15.0	6.0	.35	500	Reel	XX	MTO	3204-5661	\$3.39
Black	1	25.4	1.48	37.6	300	20.7	10.0	8.0	.59	400	Reel	XX	MTO	3204-1718	4.44
Blue	3/8	9.5	.69	17.5	300	20.7	30.0	3.0	.15	500	Reel	XX	MTO	3204-1501	2.30
Blue	1/2	12.7	.83	21.1	300	20.7	25.0	5.0	.20	500	Reel	XX	MTO	3204-1503	2.82
Blue	3/4	19.1	1.15	29.2	300	20.7	15.0	6.0	.35	50	Bulk	200	Stock	3204-0560	3.68
Blue	3/4	19.1	1.15	29.2	300	20.7	15.0	6.0	.35	500	Reel	XX	Stock	3204-1505	3.68
Green	3/8	9.5	.69	17.5	300	20.7	30.0	3.0	.15	500	Reel	XX	MTO	3204-1511	2.30
Green	1/2	12.7	.83	21.1	300	20.7	25.0	5.0	.20	500	Reel	XX	MTO	3204-1513	2.82
Green	3/4	19.1	1.15	29.2	300	20.7	15.0	6.0	.35	50	Bulk	200	Stock	3204-0506	3.68
Green	3/4	19.1	1.15	29.2	300	20.7	15.0	6.0	.35	500	Reel	XX	Stock	3204-1515	3.68
Red	1/4	6.4	.53	13.5	300	20.7	30.0	3.0	.10	500	Reel	XX	Stock	3204-1307	1.53
Red	1/4	6.4	.53	13.5	300	20.7	30.0	3.0	.10	500	Reel	T	Stock	3204-5307	1.68
Red	3/8	9.5	.67	17.0	300	20.7	30.0	3.0	.15	500	Reel	XX	Stock	3204-1325	1.88
Red	3/8	9.5	.67	17.0	300	20.7	30.0	3.0	.15	500	Reel	T	Stock	3204-5326	2.07
Red	1/2	12.7	.83	21.1	300	20.7	25.0	5.0	.20	500	Reel	XX	Stock	3204-1334	2.27
Red	1/2	12.7	.83	21.1	300	20.7	25.0	5.0	.22	500	Reel	T	Stock	3204-5334	2.50
Red	3/4	19.1	1.15	29.2	300	20.7	15.0	6.0	.35	50	Bulk	200	Stock	3204-5675	3.23
Red	3/4	19.1	1.15	29.2	300	20.7	15.0	6.0	.35	500	Reel	XX	Stock	3204-1355	3.23
Red	3/4	19.1	1.15	29.2	300	20.7	15.0	6.0	.35	500	Reel	T	Stock	3204-5355	3.55
Red	1	25.4	1.47	37.3	300	20.7	10.0	8.0	.54	400	Reel	T	Stock	3204-0901	4.44
Red	1	25.4	1.47	37.3	300	20.7	10.0	8.0	.54	400	Reel	XX	Stock	3204-1364	5.46
Red	1	25.4	1.47	37.3	300	20.7	10.0	8.0	.60	500	Reel	XX	Stock	3204-1650	5.46
Yellow	3/8	9.5	.69	17.5	300	20.7	30.0	3.0	.15	500	Reel	XX	MTO	3204-1521	2.30
Yellow	1/2	12.7	.83	21.1	300	20.7	25.0	5.0	.20	500	Reel	XX	MTO	3204-1523	2.82
Yellow	3/4	19.1	1.15	29.2	300	20.7	15.0	6.0	.37	50	Bulk	200	Stock	3204-0558	3.68
Yellow	3/4	19.1	1.15	29.2	300	20.7	15.0	6.0	.35	500	Reel	XX	Stock	3204-1525	3.68

NOTE: Pkg Code T=One piece continuous length reel. Pkg Code XX=Two piece reel, 50 ft increments, no length less than 50 ft.

**RECOMMENDED FOR:** Air and water applications requiring maximum flexibility in any industry, including mining, construction, agriculture, vehicle repair and in-plant operations. Outstanding resistance to heat and ozone. Suitable for light agricultural spraying, such as dilute solutions of herbicides.

**TEMPERATURE:** -40°F to +200°F (-40°C to +93°C) continuous service.

**CONSTRUCTION:** **Tube:** Type P (EPDM). Black.  
**Reinforcement:** Synthetic, high tensile textile cord.  
**Cover:** Type P (EPDM). All sizes through 1/2" are perforated.  
**Design Factor:** 3:1

**COUPLINGS:** 19 (up through 1/2" only), 1, 3 or 4, (up through 1/2" with 20 brass ferrules, up through 1" with bands), 72 Gates Power Crimp® or 75 Gates GLX®. Reference the Hose Coupling Section.

**STANDARDS:** **Tube:** ARPM (Class C) Limited oil-resistance.  
**Cover:** ARPM (Class C) Limited oil-resistance.

AGRICULTURE

AIR BREATHING

AIR DUCT

AIR AND MULTI-PURPOSE

CHEMICAL

FOOD AND BEVERAGE

MARINE AND ENGINE

MATERIAL HANDLING

MINING

OILFIELD

PETROLEUM

PRESSURE WASH AND WASHDOWN

STEAM

WATER

CLAMPS

COUPLINGS AND FERRULES

HOSE FINDER

CHEMICAL RESISTANCE TABLE



## Air and Multi-Purpose Hose

### Plant Master® 250 Black Formerly - Adapta Flex™



#### 250 Black

Color	Hose I.D.		Hose O.D.		Max. W.P.		Vac.	MBR	Wt. Per ft	Length	Std. Pack	Pkg Code	Stock or MTO	Gates Item No.	List Price Per ft
	(in)	(mm)	(in)	(mm)	(psi)	(Bar)									
Black	1/4	6.4	.50	12.7	250	17.2	30.0	3.0	.08	500	Reel	XX	MTO	3204-1404	\$1.44
Black	1/4	6.4	.62	15.7	250	17.2	30.0	3.0	.08	500	Reel	XX	MTO	3204-1406	2.27
Black	3/8	9.5	.66	16.8	250	17.2	30.0	3.0	.14	500	Reel	XX	Stock	3204-1410	1.77
Black	3/8	9.5	.66	16.8	250	17.2	30.0	3.0	.14	500	Reel	T	Stock	3204-4431	1.95
Black	1/2	12.7	.81	20.6	250	17.2	25.0	5.0	.19	500	Reel	XX	Stock	3204-1416	2.07
Black	1/2	12.7	.81	20.6	250	17.2	25.0	5.0	.19	500	Reel	T	Stock	3204-4432	2.28
Black	3/4	19.1	1.15	29.2	250	17.2	20.0	6.0	.35	50	Bulk	200	Stock	3204-5820	2.84
Black	3/4	19.1	1.15	29.2	250	17.2	20.0	6.0	1.29	200	UPS	XX	MTO	3204-1427	2.84
Black	3/4	19.1	1.15	29.2	250	17.2	20.0	6.0	.35	500	Reel	XX	Stock	3204-1425	2.84
Black	3/4	19.1	1.15	29.2	250	17.2	20.0	6.0	.35	500	Reel	T	Stock	3204-4433	3.12
Black	1 1/4	31.8	1.73	43.9	250	17.2	10.0	10.0	.68	200	Reel	XX	Stock	3204-1434	6.44
Black	1 1/2	38.1	1.98	50.3	250	17.2	10.0	12.0	.85	200	Reel	XX	Stock	3204-1437	8.04

NOTE: Pkg Code T=One piece continuous length reel. Pkg Code XX=Two piece reel, 50 ft increments, no length less than 50 ft.

#### Assemblies

Color	Hose I.D.		Hose O.D.		Max. W.P.		Vac.	MBR	Wt. Per ea	Length	Std. Pack	Pkg Code	Stock or MTO	Gates Item No.	List Price Per ea
	(in)	(mm)	(in)	(mm)	(psi)	(Bar)									
Black	3/8	9.5	.66	16.8	250	17.2	30.0	3.0	7.43	50	Bulk	5	MTO	3204-1721	\$111.92

NOTE: Termination ends are 1/4" male NPT.

**RECOMMENDED FOR:** Air and water applications requiring maximum flexibility in any industry, including mining, construction, agriculture, vehicle repair and in-plant operations. Outstanding resistance to heat and ozone. Suitable for light agricultural spraying, such as dilute solutions of herbicides.

**TEMPERATURE:** -40°F to +200°F (-40°C to +93°C) continuous service.

**CONSTRUCTION:**  
**Tube:** Type P (EPDM). Black.  
**Reinforcement:** Synthetic, high tensile textile cord.  
**Cover:** Type P (EPDM). All sizes through 1/2" are perforated.  
**Design Factor:** 3:1

**COUPLINGS:** 19 (up through 1/2" only), 1, 3 or 4, (up through 1/2" with 20 brass ferrules, up through 1" with bands), 72 Gates Power Crimp® or 75 Gates GLX®. Reference the Hose Coupling Section.

**STANDARDS:**  
**Tube:** ARPM (Class C) Limited oil-resistance.  
**Cover:** ARPM (Class C) Limited oil-resistance.

## Air and Multi-Purpose Hose

### Plant Master® 250 Colors

Formerly - Adapta Flex™



#### 250 Colors

Color	Hose I.D.	⊖	Hose O.D.	⊕	Max. W.P.	⊕	Vac.	MBR	Wt. Per ft	Length	Std. Pack	Pkg Code	Stock or MTO (ft)	Gates Item No.	List Price Per ft
	(in)	(mm)	(in)	(mm)	(psi)	(Bar)	(In. Hg)	(in)	(Lbs.)	(ft)					
Blue	1/4	6.4	.50	12.7	250	17.2	30.0	3.0	.08	500	Reel	XX	MTO	3204-1496	\$1.61
Blue	3/8	9.5	.66	16.8	250	17.2	30.0	3.0	.14	500	Reel	XX	Stock	3204-1497	1.98
Blue	1/2	12.7	.81	20.6	250	17.2	25.0	5.0	.19	500	Reel	XX	Stock	3204-1498	2.37
Blue	3/4	19.1	1.15	29.2	250	17.2	20.0	6.0	.35	500	Reel	XX	Stock	3204-1500	3.36
Green	1/4	6.4	.50	12.7	250	17.2	30.0	3.0	.08	500	Reel	XX	MTO	3204-1516	1.61
Green	3/8	9.5	.66	16.8	250	17.2	30.0	3.0	.14	500	Reel	XX	MTO	3204-1517	1.98
Green	1/2	12.7	.81	20.6	250	17.2	25.0	5.0	.19	500	Reel	XX	MTO	3204-1518	2.37
Green	3/4	19.1	1.15	29.2	250	17.2	20.0	6.0	.35	500	Reel	XX	MTO	3204-1520	3.36
Red	1/4	6.4	.50	12.7	250	17.2	30.0	3.0	.08	100	Bulk	500	MTO	3204-1731	1.10
Red	1/4	6.4	.50	12.7	250	17.2	30.0	3.0	.08	500	Reel	XX	Stock	3204-1304	1.46
Red	1/4	6.4	.50	12.7	250	17.2	30.0	3.0	.08	500	Reel	T	Stock	3204-5304	1.61
Red	1/4	6.4	.62	15.7	250	17.2	30.0	3.0	.08	500	Reel	XX	MTO	3204-1386	2.27
Red	3/8	9.5	.66	16.8	250	17.2	30.0	3.0	.14	500	Reel	XX	Stock	3204-1322	1.80
Red	3/8	9.5	.66	16.8	250	17.2	30.0	3.0	.14	500	Reel	T	Stock	3204-5321	1.98
Red	1/2	12.7	.81	20.6	250	17.2	25.0	5.0	.19	500	Reel	XX	Stock	3204-1331	2.16
Red	1/2	12.7	.81	20.6	250	17.2	25.0	5.0	.19	500	Reel	T	Stock	3204-5333	2.38
Red	5/8	15.9	.97	24.6	250	17.2	20.0	6.0	.26	50	Bulk	250	MTO	3204-5415	2.55
Red	5/8	15.9	.97	24.6	250	17.2	20.0	6.0	.26	500	Reel	XX	Stock	3204-1340	2.55
Red	5/8	15.9	.97	24.6	250	17.2	20.0	6.0	.25	500	Reel	T	Stock	3204-5341	2.81
Red	3/4	19.1	1.11	28.2	250	17.2	20.0	6.0	.35	500	Reel	XX	Stock	3204-1349	3.06
Red	3/4	19.1	1.11	28.2	250	17.2	20.0	6.0	.35	500	Reel	T	Stock	3204-5349	3.37
Red	3/4	19.1	1.15	29.2	250	17.2	20.0	6.0	.35	50	Bulk	200	Stock	3204-5420	3.06
Yellow	1/4	6.4	.50	12.7	250	17.2	30.0	3.0	.08	500	Reel	XX	MTO	3204-1526	1.61
Yellow	3/8	9.5	.66	16.8	250	17.2	30.0	3.0	.14	500	Reel	XX	MTO	3204-1527	1.98
Yellow	1/2	12.7	.81	20.6	250	17.2	25.0	5.0	.19	500	Reel	XX	Stock	3204-1528	2.37
Yellow	3/4	19.1	1.15	29.2	250	17.2	20.0	6.0	.35	500	Reel	XX	MTO	3204-1530	3.36
Yellow	1	25.4	1.47	37.3	250	17.2	10.0	8.0	.62	400	Reel	XX	MTO	3204-1532	3.49

NOTE: Pkg Code T=One piece continuous length reel. Pkg Code XX=Two piece reel, 50 ft increments, no length less than 50 ft.

#### Assemblies

Color	Hose I.D.	⊖	Hose O.D.	⊕	Max. W.P.	⊕	Vac.	MBR	Wt. Per ea	Length	Std. Pack	Pkg Code	Stock or MTO (ea)	Gates Item No.	List Price Per ea
	(in)	(mm)	(in)	(mm)	(psi)	(Bar)	(In. Hg)	(in)	(Lbs.)	(ea)					
Red	3/8	9.5	.66	16.8	250	17.2	30.0	3.0	7.72	50	Assy	8	Stock	3204-1720	\$113.39
Red	3/8	9.5	.66	16.8	250	17.2	30.0	3.0	6.53	50	Bulk	54	Stock	3204-1900	102.05

NOTE: Termination ends are 1/4" male NPT.

**RECOMMENDED FOR:** Air and water applications requiring maximum flexibility in any industry, including mining, construction, agriculture, vehicle repair and in-plant operations. Outstanding resistance to heat and ozone. Suitable for light agricultural spraying, such as dilute solutions of herbicides.

**TEMPERATURE:** -40°F to +200°F (-40°C to +93°C) continuous service.

**CONSTRUCTION:**  
**Tube:** Type P (EPDM). Black.  
**Reinforcement:** Synthetic, high tensile textile cord.  
**Cover:** Type P (EPDM). All sizes through 1/2" are perforated.  
**Design Factor:** 3:1

**COUPLINGS:** 19 (up through 1/2" only), 1, 3 or 4, (up through 1/2" with 20 brass ferrules, up through 1" with bands), 72 Gates Power Crimp® or 75 Gates GLX®. Reference the Hose Coupling Section.

**STANDARDS:**  
**Tube:** ARPM (Class C) Limited oil-resistance.  
**Cover:** ARPM (Class C) Limited oil-resistance.

AGRICULTURE

AIR BREATHING

AIR DUCT

AIR AND MULTI-PURPOSE

CHEMICAL

FOOD AND BEVERAGE

MARINE AND ENGINE

MATERIAL HANDLING

MINING

OILFIELD

PETROLEUM

PRESSURE WASH AND WASHDOWN

STEAM

WATER

CLAMPS

COUPLINGS AND FERRULES

HOSE FINDER

CHEMICAL RESISTANCE TABLE

## Air and Multi-Purpose Hose

### Plant Master® (150-200)

Formerly - Adapta Flex™



AGRICULTURE
AIR BREATHING
AIR DUCT
AIR AND MULTI-PURPOSE
CHEMICAL
FOOD AND BEVERAGE
MARINE AND ENGINE
MATERIAL HANDLING
MINING
OILFIELD
PETROLEUM
PRESSURE WASH AND WASHDOWN
STEAM
WATER
CLAMPS
COUPLINGS AND FERRULES
HOSE FINDER
CHEMICAL RESISTANCE TABLE

Color	Hose I.D.	Hose O.D.	Max. W.P.	Vac.	MBR	Wt. Per ft	Length	Std. Pack	Pkg Code	Stock or MTO	Gates Item No.	List Price Per ft			
	(in)	(mm)											(in)	(mm)	(psi)
Black	1/4	6.4	.50	12.7	200	13.8	30.0	3.0	.09	500	Reel	XX	Stock	3204-1401	\$1.05
Black	1/4	6.4	.50	12.7	200	13.8	30.0	3.0	.09	500	Reel	T	Stock	3204-4402	1.16
Black	5/16	7.9	.53	13.5	200	13.8	30.0	3.0	.09	500	Reel	XX	MTO	3204-0710	1.29
Black	3/8	9.5	.66	16.8	200	13.8	30.0	3.0	.14	500	Reel	XX	Stock	3204-1407	1.50
Black	3/8	9.5	.66	16.8	200	13.8	30.0	3.0	.15	500	UPS	XX	Stock	3204-1408	1.05
Black	3/8	9.5	.66	16.8	200	13.8	30.0	3.0	.14	500	Reel	T	Stock	3204-4407	1.65
Black	1/2	12.7	.81	20.6	200	13.8	25.0	5.0	.21	250	UPS	XX	Stock	3204-1414	1.79
Black	1/2	12.7	.81	20.6	200	13.8	25.0	5.0	.20	500	Reel	XX	Stock	3204-1413	1.79
Black	1/2	12.7	.81	20.6	200	13.8	25.0	5.0	.19	500	Reel	T	Stock	3204-4413	1.97
Black	5/8	15.9	.97	24.6	200	13.8	20.0	6.0	.26	500	Reel	XX	Stock	3204-1419	2.15
Black	3/4	19.1	1.11	28.2	200	13.8	15.0	6.0	.32	500	Reel	XX	Stock	3204-1422	2.51
Black	3/4	19.1	1.11	28.2	200	13.8	15.0	6.0	.23	500	Reel	T	Stock	3204-4422	2.76
Black	1	25.4	1.40	35.6	200	13.8	10.0	8.0	1.11	125	UPS	XX	Stock	3204-1432	4.52
Black	1	25.4	1.40	35.6	150	10.3	10.0	8.0	.48	400	Reel	XX	Stock	3204-1428	4.20
Black	1	25.4	1.40	35.6	200	13.8	10.0	8.0	.48	400	Reel	XX	Stock	3204-1431	4.52
Red	1/4	6.4	.50	12.7	200	13.8	30.0	3.0	.08	50	Bulk	500	MTO	3204-1730	1.10
Red	1/4	6.4	.50	12.7	200	13.8	30.0	3.0	.09	500	Reel	XX	Stock	3204-1301	1.10
Red	1/4	6.4	.50	12.7	200	13.8	30.0	3.0	.09	500	UPS	XX	Stock	3204-1373	1.10
Red	1/4	6.4	.50	12.7	200	13.8	30.0	3.0	.11	500	Reel	T	Stock	3204-5301	1.21
Red	5/16	7.9	.53	13.5	200	13.8	30.0	3.0	.09	500	Reel	XX	Stock	3204-1316	1.41
Red	3/8	9.5	.66	16.8	200	13.8	30.0	3.0	.14	400	UPS	XX	Stock	3204-1375	1.52
Red	3/8	9.5	.66	16.8	200	13.8	30.0	3.0	.14	500	Reel	XX	Stock	3204-1319	1.52
Red	3/8	9.5	.66	16.8	200	13.8	30.0	3.0	.14	500	Reel	T	Stock	3204-5319	1.67
Red	1/2	12.7	.81	20.6	200	13.8	25.0	5.0	.23	250	UPS	XX	Stock	3204-1377	1.80
Red	1/2	12.7	.81	20.6	200	13.8	25.0	5.0	.20	500	Reel	XX	Stock	3204-1328	1.80
Red	1/2	12.7	.81	20.6	200	13.8	25.0	5.0	.22	500	Reel	T	Stock	3204-5328	1.98
Red	5/8	15.9	.97	24.6	200	13.8	20.0	6.0	.26	250	UPS	XX	Stock	3204-1379	2.31
Red	5/8	15.9	.97	24.6	200	13.8	20.0	6.0	.26	500	Reel	XX	Stock	3204-1337	2.31
Red	5/8	15.9	.97	24.6	200	13.8	20.0	6.0	.29	500	Reel	T	Stock	3204-5337	2.54
Red	3/4	19.1	1.11	28.2	200	13.8	15.0	6.0	.31	50	Bulk	200	MTO	3204-1636	2.69
Red	3/4	19.1	1.11	28.2	200	13.8	15.0	6.0	.31	200	UPS	XX	Stock	3204-1381	2.69
Red	3/4	19.1	1.11	28.2	200	13.8	15.0	6.0	.31	500	Reel	XX	Stock	3204-1346	2.69
Red	3/4	19.1	1.11	28.2	200	13.8	15.0	6.0	.36	500	Reel	T	Stock	3204-5346	2.96
Red	1	25.4	1.39	35.3	150	10.3	10.0	8.0	.48	400	Reel	XX	Stock	3204-1358	4.58
Red	1	25.4	1.39	35.3	200	13.8	10.0	8.0	.48	400	Reel	XX	Stock	3204-1361	4.73
Red	1	25.4	1.40	35.6	200	13.8	10.0	8.0	.45	125	UPS	XX	Stock	3204-1383	4.73

NOTE: Pkg Code T=One piece continuous length reel. Pkg Code XX=Two piece reel, 50 ft increments, no length less than 50 ft.

**RECOMMENDED FOR:** Air and water applications requiring maximum flexibility in any industry, including mining, construction, agriculture, vehicle repair and in-plant operations. Outstanding resistance to heat and ozone. Suitable for light agricultural spraying, such as dilute solutions of herbicides.

**TEMPERATURE:** -40°F to +200°F (-40°C to +93°C) continuous service.

**CONSTRUCTION:** **Tube:** Type P (EPDM). Black.  
**Reinforcement:** Synthetic, high tensile textile cord.  
**Cover:** Type P (EPDM). All sizes through 1/2" are perforated.  
**Design Factor:** 3:1

**COUPLINGS:** 19 (up through 1/2" only), 1, 3 or 4, (up through 1/2" with 20 brass ferrules, up through 1" with bands), 72 Gates Power Crimp® or 75 Gates GLX®. Reference the Hose Coupling Section.

**STANDARDS:** **Tube:** ARPM (Class C) Limited oil-resistance.  
**Cover:** ARPM (Class C) Limited oil-resistance.

## Air and Multi-Purpose Hose

### Plant Master® 300 NC

Formerly - Ohmega®



Color	Hose I.D.		Hose O.D.		Max. W.P.		Vac.	MBR	Wt. Per ft	Length	Std. Pack	Pkg Code	Stock or MTO	Gates Item No.	List Price Per ft
	(in)	(mm)	(in)	(mm)	(psi)	(Bar)									
Red	1/4	6.4	.62	15.7	300	20.7	30.0	3.0	.16	500	Reel	XX	MTO	3237-0708	\$2.72
Red	3/8	9.5	.75	19.1	300	20.7	30.0	3.0	.19	500	Reel	XX	Stock	3237-0704	3.84
Red	1/2	12.7	.88	22.4	300	20.7	25.0	5.0	.24	500	Reel	XX	Stock	3237-0705	4.56
Red	3/4	19.1	1.16	29.5	300	20.7	20.0	6.0	.36	500	Reel	XX	Stock	3237-0706	6.23

NOTE: For additional sizes or applications requiring oil-resistance see Plant Master® XTreme™.

**RECOMMENDED FOR:** Medium-duty air and water applications where a hose with high electrical resistance is needed.

**TEMPERATURE:** -20°F to +150°F (-29°C to +66°C) continuous service.

**CONSTRUCTION:** **Tube:** Type P (EPDM). Green. Carbon free.  
**Reinforcement:** High tensile synthetic textile cord.  
**Cover:** Type P (EPDM). Red. Carbon free.  
**Design Factor:** 4:1

**COUPLINGS:** 19 (For sizes 3/16" through 3/8" only), 1, 18 or 75 Gates GLX®. Reference the Hose Coupling Section.

**STANDARDS:** Non-conductive (>1 Megohm/in.).  
 Storage and use may adversely affect electrical resistance.  
**Tube:** ARPM (Class C) Limited oil-resistance.  
**Cover:** ARPM (Class C) Limited oil-resistance.

AGRICULTURE

AIR BREATHING

AIR DUCT

AIR AND MULTI-PURPOSE

CHEMICAL

FOOD AND BEVERAGE

MARINE AND ENGINE

MATERIAL HANDLING

MINING

OILFIELD

PETROLEUM

PRESSURE WASH AND WASHDOWN

STEAM

WATER

CLAMPS

COUPLINGS AND FERRULES

HOSE FINDER

CHEMICAL RESISTANCE TABLE

## Chemical Hose

### Chem Master™ XTreme™ FEP (125-200) SD Formerly - Stallion®



AGRICULTURE
AIR BREATHING
AIR DUCT
AIR AND MULTI-PURPOSE
CHEMICAL
FOOD AND BEVERAGE
MARINE AND ENGINE
MATERIAL HANDLING
MINING
OILFIELD
PETROLEUM
PRESSURE WASH AND WASHDOWN
STEAM
WATER
CLAMPS
COUPLINGS AND FERRULES
HOSE FINDER
CHEMICAL RESISTANCE TABLE

Color	Hose I.D.		Hose O.D.		Max. W.P.		Vac.	MBR	Wt. Per ft	Length	Std. Pack	Pkg Code	Stock or MTO	Gates Item No.	List Price Per ft
	(in)	(mm)	(in)	(mm)	(psi)	(Bar)	(In. Hg)	(in)	(Lbs.)	(ft)			(ft)		
Blue	3/4	19.1	1.29	32.8	200	13.8	30.0	4.0	.52	20	PLT	T	MTO	4698-0021	\$55.10
Blue	3/4	19.1	1.29	32.8	200	13.8	30.0	4.0	.52	100	PLT	T	Stock	4698-0011	55.10
Blue	1	25.4	1.56	39.6	200	13.8	30.0	5.0	.63	20	PLT	T	Stock	4698-0022	64.79
Blue	1	25.4	1.56	39.6	200	13.8	30.0	5.0	.63	100	PLT	T	Stock	4698-0012	64.79
Blue	1	25.4	1.56	39.6	200	13.8	30.0	5.0	.63	200	PLT	T	MTO	4698-0029	64.79
Blue	1 1/4	31.8	1.80	45.7	200	13.8	30.0	7.0	.74	100	PLT	T	MTO	4698-0104	76.49
Blue	1 1/2	38.1	2.05	52.1	200	13.8	30.0	8.0	.93	20	PLT	T	Stock	4698-0023	88.17
Blue	1 1/2	38.1	2.05	52.1	200	13.8	30.0	8.0	.93	100	PLT	T	Stock	4698-0013	88.17
Blue	1 1/2	38.1	2.05	52.1	200	13.8	30.0	8.0	.93	200	PLT	T	MTO	4698-0031	88.17
Blue	2	50.8	2.55	64.8	200	13.8	30.0	9.0	1.14	20	PLT	T	Stock	4698-0024	107.57
Blue	2	50.8	2.55	64.8	200	13.8	30.0	9.0	1.14	100	PLT	T	Stock	4698-0014	107.57
Blue	2 1/2	63.5	3.07	78.0	150	10.3	30.0	12.0	1.44	20	PLT	T	MTO	4698-0025	135.80
Blue	2 1/2	63.5	3.07	78.0	150	10.3	30.0	12.0	1.44	100	PLT	T	Stock	4698-0015	135.80
Blue	3	76.2	3.59	91.2	150	10.3	30.0	18.0	1.77	20	PLT	T	Stock	4698-0026	160.55
Blue	3	76.2	3.59	91.2	150	10.3	30.0	18.0	1.77	100	PLT	T	Stock	4698-0016	160.55
Blue	4	101.6	4.66	118.4	125	8.6	30.0	24.0	2.60	20	PLT	T	Stock	4698-0027	225.80
Blue	4	101.6	4.66	118.4	125	8.6	30.0	24.0	2.60	100	PLT	T	Stock	4698-0017	225.80

**RECOMMENDED FOR:** Tank truck, barge, ship, or storage tank transfer of a variety of chemical products. Chem Master™ XTreme™ FEP has a wire helix for full suction capability. The tube stock Fluoroethylenepropylene (FEP) has excellent chemical resistance and is backed by Gates Gatron™ for flex fatigue safety at the coupling. Chem Master™ XTreme™ FEP is designed for easy cleaning in a bath containing 10% (NaOH) @ +212°F (+100°C). Cleaning in place (CIP) methods may be used. Applications include most basic chemicals which are building blocks for numerous chemicals used in a variety of industries. Reference Gates Chemical Resistance Table for proper hose selection. Compatible with commercially available Bio-Diesel fuels up to B-100.

**CAUTION:** Chem Master™ XTreme™ FEP is designed to withstand fluid temperatures to +300°F (+149°C); however the rating is dependent on the specific chemical conveyed. Contact Denver Product Application (303) 744-5070 for any chemical above +125°F (+52°C).

**TEMPERATURE:** -40°F to +300°F (-40°C to +149°C) normal service.

**CONSTRUCTION:**  
**Tube:** Type T (FEP) Fluoroethylenepropylene. White. Backed with Gatron™ (Modified XLPE).  
**Reinforcement:** Synthetic, high tensile textile with steel wire helix.  
**Cover:** Type P (EPDM). Blue corrugated with orange stripe.  
**Design Factor:** 4:1

**COUPLINGS:** Use permanent fittings only 71 or 73 for fluid temperatures up to +300°F (+149°C). Reference the Hose Coupling Section.

**STANDARDS:** Meets FDA requirements.

## Chemical Hose

### Chem Master™ XTreme™ FEP 200SD CR

Formerly - Stallion® Crush Resistant



Color	Hose I.D.		Hose O.D.		Max. W.P.		Vac.	MBR	Wt. Per ft	Length	Std. Pack	Pkg Code	Stock or MTO	Gates Item No.	List Price Per ft
	(in)		(mm)		(in)				(mm)				(psi)		
Blue	3/4	19.1	1.33	33.8	200	13.8	20.0	4.0	.52	100	PLT	T	MTO	4698-0001	\$60.60
Blue	1	25.4	1.58	40.1	200	13.8	20.0	5.0	.63	50	PLT	T	Stock	4698-0072	29.12
Blue	1	25.4	1.58	40.1	200	13.8	20.0	5.0	.63	100	PLT	T	Stock	4698-0002	71.27
Blue	1 1/2	38.1	2.08	52.8	200	13.8	20.0	8.0	.93	100	PLT	T	MTO	4698-0003	97.01
Blue	2	50.8	2.58	65.5	200	13.8	20.0	9.0	1.17	50	PLT	T	Stock	4698-0073	39.31
Blue	2	50.8	2.58	65.5	200	13.8	20.0	9.0	1.14	100	PLT	T	Stock	4698-0004	118.31

**RECOMMENDED FOR:** Tank truck, barge, ship, or storage tank transfer of a variety of chemical products. Chem Master™ XTreme™ FEP CR has a monofilament helix for suction and crush resistant capability. The tube stock Fluoroethylenepropylene (FEP) has excellent chemical resistance and is backed by Gates Gatron™ for flex fatigue safety at the coupling. Chem Master™ XTreme™ FEP CR is designed for easy cleaning in a bath containing 10% (NaOH) @ +212°F (+100°C). Cleaning in place (CIP) methods may be used. Applications include most basic chemicals which are building blocks for numerous chemicals used in a variety of industries. Reference Gates Chemical Resistance Table for proper hose selection. Compatible with commercially available Bio-Diesel fuels up to B-100.

**CAUTION:** Chem Master™ XTreme™ FEP CR is designed to withstand fluid temperatures to +300°F (+149°C); however the rating is dependent on the specific chemical conveyed. Contact Denver Product Application (303) 744-5070 for any chemical above +125°F (+52°C).

**TEMPERATURE:** -40°F to +300°F (-40°C to +149°C) normal service.

**CONSTRUCTION:**  
**Tube:** Type T (FEP) Fluoroethylenepropylene. White. Backed with Gatron™ (Modified XLPE).  
**Reinforcement:** Synthetic, high tensile textile with monofilament helix and static wire.  
**Cover:** Type P (EPDM). Blue corrugated with orange stripe.  
**Design Factor:** 4:1

**COUPLINGS:** Use permanent fittings only 71 or 73 for fluid temperatures up to +300°F (+149°C). Reference the Hose Coupling Section.

**STANDARDS:** Meets FDA requirements.

AGRICULTURE

AIR BREATHING

AIR DUCT

AIR AND MULTI-PURPOSE

CHEMICAL

FOOD AND BEVERAGE

MARINE AND ENGINE

MATERIAL HANDLING

MINING

OILFIELD

PETROLEUM

PRESSURE WASH AND WASHDOWN

STEAM

WATER

CLAMPS

COUPLINGS AND FERRULES

HOSE FINDER

CHEMICAL RESISTANCE TABLE

## Chemical Hose

### Chem Master™ Plus XLPE (150-200) SD

Formerly - Mustang®



AGRICULTURE
AIR BREATHING
AIR DUCT
AIR AND MULTI-PURPOSE
CHEMICAL
FOOD AND BEVERAGE
MARINE AND ENGINE
MATERIAL HANDLING
MINING
OILFIELD
PETROLEUM
PRESSURE WASH AND WASHDOWN
STEAM
WATER
CLAMPS
COUPLINGS AND FERRULES
HOSE FINDER
CHEMICAL RESISTANCE TABLE

Color	Hose I.D.	Hose O.D.	Max. W.P.	Vac.	MBR	Wt. Per ft	Length	Std. Pack	Pkg Code	Stock or MTO	Gates Item No.	List Price Per ft			
	(in)	(mm)	(in)	(mm)	(psi)	(Bar)	(In. Hg)	(in)	(Lbs.)	(ft)	(ft)				
Black	3/4	19.1	1.25	31.8	200	13.8	30.0	4.0	.45	100	PLT	T	Stock	4695-0002	\$29.57
Black	3/4	19.1	1.25	31.8	200	13.8	30.0	4.0	.45	200	PLT	T	MTO	4695-0737	29.57
Black	1	25.4	1.50	38.1	200	13.8	30.0	5.0	.56	100	PLT	T	Stock	4695-0003	31.13
Black	1	25.4	1.50	38.1	200	13.8	30.0	5.0	.56	200	PLT	T	MTO	4695-0670	32.66
Black	1 1/4	31.8	1.75	44.5	200	13.8	30.0	6.0	.70	100	PLT	T	Stock	4695-0004	32.85
Black	1 1/4	31.8	1.75	44.5	200	13.8	30.0	6.0	.70	200	PLT	T	MTO	4695-0738	32.85
Black	1 1/2	38.1	2.04	51.8	200	13.8	30.0	8.0	.87	100	PLT	T	Stock	4695-0005	35.54
Black	1 1/2	38.1	2.04	51.8	200	13.8	30.0	8.0	.70	200	PLT	T	MTO	4695-0729	35.54
Black	2	50.8	2.54	64.5	200	13.8	30.0	9.0	1.08	100	PLT	T	Stock	4695-0001	44.78
Black	2	50.8	2.54	64.5	200	13.8	30.0	9.0	1.08	200	PLT	T	MTO	4695-0698	44.78
Black	2 1/2	63.5	3.05	77.5	150	10.3	30.0	12.0	1.41	100	PLT	T	Stock	4695-0006	53.10
Black	2 1/2	63.5	3.05	77.5	150	10.3	30.0	12.0	1.41	200	PLT	T	MTO	4695-0720	53.10
Black	3	76.2	3.58	90.9	150	10.3	30.0	18.0	1.81	100	PLT	T	Stock	4695-0007	63.74
Black	3	76.2	3.58	90.9	150	10.3	30.0	18.0	1.81	200	PLT	T	MTO	4695-0699	63.74
Black	4	101.6	4.69	119.1	150	10.3	30.0	24.0	2.72	100	PLT	T	Stock	4695-0008	78.45
Black	4	101.6	4.69	119.1	150	10.3	30.0	24.0	2.72	200	PLT	T	MTO	4695-0055	78.45
Green	1	25.4	1.50	38.1	200	13.8	30.0	5.0	.56	100	PLT	T	Stock	4695-0628	31.13
Green	1 1/2	38.1	2.04	51.8	200	13.8	30.0	8.0	.87	100	PLT	T	Stock	4695-0211	35.54
Green	2	50.8	2.54	64.5	200	13.8	30.0	9.0	1.08	100	PLT	T	Stock	4695-0216	44.78
Green	2	50.8	2.54	64.5	200	13.8	30.0	9.0	1.08	200	PLT	T	MTO	4695-0700	44.78
Green	2 1/2	63.5	3.05	77.5	150	10.3	30.0	12.0	1.28	100	PLT	T	MTO	4695-0774	54.26
Green	3	76.2	3.58	90.9	150	10.3	30.0	18.0	1.81	100	PLT	T	Stock	4695-0229	63.74
Green	3	76.2	3.58	90.9	150	10.3	30.0	18.0	1.81	200	PLT	T	MTO	4695-0701	63.74

**RECOMMENDED FOR:** Tank truck, barge, ship, or storage tank transfer of a variety of chemical products. Chem Master™ Plus XLPE contains a wire helix for full suction capability, as well as for routing hoses through tight bends. Its Modified Cross-linked Polyethylene tube stock is 'best in class' for maintaining a tight seal with stainless steel fittings, and is designed for cleaning with 'open-end' 50 PSI steam or in a bath containing 10% (NaOH) @ +212°F (+100°C). Cleaning in place (CIP) methods may be used. Applications include over 950 basic chemicals that are building blocks for numerous chemicals used in a variety of industries. Reference Gates Chemical Resistance Table for proper hose selection.

**CAUTION:** For applications requiring greater than 90% sulfuric acid contact Denver Product Application (303) 744-5070. Chem Master™ Plus XLPE is designed to withstand fluid temperatures to +250°F (+121°C); however the rating is dependent on the specific chemical conveyed. Contact Denver Product Application (303) 744-5070 for any chemical above +125°F (+52°C). Not recommended for 'closed steam' cleaning.

**TEMPERATURE:** -40°F to +250°F (-40°C to +121°C) normal service.

**CONSTRUCTION:** **Tube:** Type K (Gatron™ Modified Cross-linked Polyethylene.) Tan. High chemical resistance.  
**Reinforcement:** Synthetic, high tensile textile cord with steel wire helix.  
**Cover:** Type P (EPDM). Black or green corrugated with orange stripe. Additional color covers available on special order.

**Design Factor:** 4:1

**COUPLINGS:** Use 7, 8, or 49 for fluid temperatures to +125°F (+52°C). Use permanent fittings only 71 or 73 for fluid temperatures above +125°F (+52°C) and up to +250°F (+121°C) or 80 Gates GSP (2" only). Reference the Hose Coupling Section.



## Chemical Hose

### Chem Master™ Plus XLPE 200SD CR Formerly - Mustang® Crush Resistant



Color	Hose I.D.		Hose O.D.		Max. W.P.		Vac.	MBR	Wt. Per ft	Length	Std. Pack	Pkg Code	Stock or MTO	Gates Item No.	List Price Per ft
	(in)	(mm)	(in)	(mm)	(psi)	(Bar)									
Black	3/4	19.1	1.36	34.5	200	13.8	20.0	4.0	.45	100	PLT	T	MTO	4695-0607	\$32.52
Black	1	25.4	1.61	40.9	200	13.8	20.0	5.0	.56	100	PLT	T	MTO	4695-0608	34.23
Black	1 1/2	38.1	2.13	54.1	200	13.8	20.0	8.0	.87	100	PLT	T	Stock	4695-0609	39.08
Black	2	50.8	2.63	66.8	200	13.8	20.0	9.0	1.08	100	PLT	T	Stock	4695-0610	49.25

NOTE: Also see Black Gold® Chemical Plus XLPE 250SD

**RECOMMENDED FOR:** Tank truck, barge, ship, or storage tank transfer of a variety of chemical products. Chem Master™ Plus XLPE CR contains a monofilament helix for suction and crush resistant capability, as well as for routing hoses through tight bends. Its Modified Cross-linked Polyethylene tube stock is 'best in class' for maintaining a tight seal with stainless steel fittings, and is designed for cleaning with 'open-end' 50 PSI steam or in a bath containing 10% (NaOH) @ +212°F (+100°C). Cleaning in place (CIP) methods may be used. Applications include over 950 basic chemicals that are building blocks for numerous chemicals used in a variety of industries. Reference Gates Chemical Resistance Table for proper hose selection.

**CAUTION:** For applications requiring greater than 90% sulfuric acid contact Denver Product Application (303) 744-5070. Chem Master™ Plus XLPE CR is designed to withstand fluid temperatures to +250°F (+121°C); however the rating is dependent on the specific chemical conveyed. Contact Denver Product Application (303) 744-5070 for any chemical above +125°F (+52°C). Not recommended for 'closed steam' cleaning.

**TEMPERATURE:** -40°F to +250°F (-40°C to +121°C) normal service.

**CONSTRUCTION:**  
**Tube:** Type K (Gatron™ Modified Cross-linked Polyethylene.) Tan. High chemical resistance.  
**Reinforcement:** Synthetic, high tensile textile with monofilament helix and static wire providing crush and kink-resistance.  
**Cover:** Type P (EPDM). Black corrugated with orange stripe. Additional color covers available on special order.  
**Design Factor:** 4:1

**COUPLINGS:** Use 7, 8, or 49 for fluid temperatures to +125°F (+52°C). Use permanent fittings only 71 or 73 for fluid temperatures above +125°F (+52°C) and up to +250°F (+121°C) or 80 Gates GSP (2" only). Reference the Hose Coupling Section.

AGRICULTURE

AIR BREATHING

AIR DUCT

AIR AND MULTI-PURPOSE

CHEMICAL

FOOD AND BEVERAGE

MARINE AND ENGINE

MATERIAL HANDLING

MINING

OILFIELD

PETROLEUM

PRESSURE WASH AND WASHDOWN

STEAM

WATER

CLAMPS

COUPLINGS AND FERRULES

HOSE FINDER

CHEMICAL RESISTANCE TABLE

## Chemical Hose

### Chem Master™ Plus UHMWPE (125-200) SD Formerly - Renegade™



AGRICULTURE
AIR BREATHING
AIR DUCT
AIR AND MULTI-PURPOSE
<b>CHEMICAL</b>
FOOD AND BEVERAGE
MARINE AND ENGINE
MATERIAL HANDLING
MINING
OILFIELD
PETROLEUM
PRESSURE WASH AND WASHDOWN
STEAM
WATER
CLAMPS
COUPLINGS AND FERRULES
HOSE FINDER
CHEMICAL RESISTANCE TABLE

Color	Hose I.D.	Hose O.D.	Max. W.P.	Vac.	MBR	Wt. Per ft	Length	Std. Pack	Pkg Code	Stock or MTO	Gates Item No.	List Price Per ft			
	(in)	(mm)											(in)	(mm)	(psi)
Green	3/4	19.1	1.22	31.0	200	13.8	30.0	4.0	.41	100	PLT	T	Stock	4697-0014	\$32.49
Green	1	25.4	1.47	37.3	200	13.8	30.0	5.0	.51	100	PLT	T	Stock	4697-0015	34.26
Green	1	25.4	1.47	37.3	200	13.8	30.0	5.0	.51	200	PLT	T	MTO	4697-0057	34.26
Green	1 1/4	31.8	1.72	43.7	200	13.8	30.0	6.0	.60	100	PLT	T	Stock	4697-0016	36.17
Green	1 1/2	38.1	2.00	50.8	200	13.8	30.0	8.0	.78	100	PLT	T	Stock	4697-0017	39.05
Green	1 1/2	38.1	2.00	50.8	200	13.8	30.0	8.0	.78	200	PLT	T	MTO	4697-0058	39.05
Green	2	50.8	2.50	63.5	200	13.8	30.0	9.0	1.08	100	PLT	T	Stock	4697-0018	49.20
Green	2	50.8	2.50	63.5	200	13.8	30.0	9.0	1.08	200	PLT	T	MTO	4697-0059	49.20
Green	2 1/2	63.5	3.01	76.5	150	10.3	30.0	12.0	1.39	100	PLT	T	Stock	4697-0019	58.43
Green	3	76.2	3.53	89.7	150	10.3	30.0	18.0	1.76	100	PLT	T	Stock	4697-0020	70.10
Green	3	76.2	3.53	89.7	150	10.3	30.0	18.0	1.76	200	PLT	T	MTO	4697-0022	70.10
Green	4	101.6	4.53	115.1	125	8.6	30.0	24.0	2.49	100	PLT	T	Stock	4697-0021	86.34

**RECOMMENDED FOR:** Tank truck, barge, ship, or storage tank transfer of a variety of chemical products. Chem Master™ Plus UHMWPE contains a wire helix for full suction capability, as well as for routing hoses through tight bends. The Ultra High Molecular Weight Polyethylene tube stock has excellent chemical resistance and is backed by Gates Gatron™ for flex fatigue safety at the coupling. Chem Master™ Plus UHMWPE is designed for easy cleaning in a bath containing 10% (NaOH) @ +212°F (+100°C). Cleaning in place (CIP) methods may be used. Applications include over 450 basic chemicals which are building blocks for numerous chemicals used in a variety of industries. Reference Gates Chemical Resistance Table for proper hose selection.

**CAUTION:** Chem Master™ Plus UHMWPE is designed to withstand fluid temperatures to +212°F (+100°C); however the rating is dependent on the specific chemical conveyed. Contact Denver Product Application (303) 744-5070 for any chemical above +125°F (+52°C).

**TEMPERATURE:** -40°F to +212°F (-40°C to +100°C) normal service.

**CONSTRUCTION:**  
**Tube:** Type L (Ultra High Molecular Weight Polyethylene). Clear, backed with Gatron™ Modified XLPE.  
**Reinforcement:** Synthetic, high tensile textile with steel wire helix.  
**Cover:** Type P (EPDM). Green corrugated with orange stripe.  
**Design Factor:** 4:1

**COUPLINGS:** Use 7, 8 or 49 for fluid temperatures to +125°F (+52°C). Use permanent fittings only 71 or 73 for fluid temperatures above +125°F (+52°C) and up to +212°F (+100°C). Reference the Hose Coupling Section.

## Chemical Hose

### Chem Master™ Plus CPE (150-200) SD MegaFlex®



Color	Hose I.D.		Hose O.D.		Max. W.P.		Vac.	MBR	Wt. Per ft	Length	Std. Pack	Pkg Code	Stock or MTO	Gates Item No.	List Price Per ft
	(in)	(mm)	(in)	(mm)	(psi)	(Bar)									
Black	3/4	19.1	1.20	30.5	200	13.8	30.0	1.5	.41	100	PLT	T	Stock	4696-0007	\$26.43
Black	1	25.4	1.46	37.1	200	13.8	30.0	2.0	.51	100	PLT	T	Stock	4696-0008	29.12
Black	1 1/4	31.8	1.72	43.7	200	13.8	30.0	2.5	.65	100	PLT	T	Stock	4696-0014	32.26
Black	1 1/2	38.1	1.92	48.8	200	13.8	30.0	3.0	.75	100	PLT	T	Stock	4696-0015	33.15
Black	2	50.8	2.48	63.0	200	13.8	30.0	4.0	1.01	100	PLT	T	Stock	4696-0016	39.31
Black	2 1/2	63.5	2.98	75.7	150	10.3	30.0	5.0	1.23	100	PLT	T	Stock	4696-0023	47.49
Black	3	76.2	3.48	88.4	150	10.3	30.0	8.0	1.61	100	PLT	T	Stock	4696-0024	56.78
Black	4	101.6	4.49	114.0	150	10.3	30.0	10.0	2.08	100	PLT	T	Stock	4696-0025	70.90

**RECOMMENDED FOR:** Tank truck, barge, ship, or storage tank transfer of a variety of chemical products. Chem Master™ Plus CPE MegaFlex® contains a wire helix for full suction capability, as well as for routing hoses through extremely tight bend radius applications.

**CAUTION:** Chem Master™ Plus CPE MegaFlex® is designed to withstand fluid temperatures to 275°F (135° C), however, the rating is dependent upon the specific chemical being conveyed. Contact Denver Product Application (303-744-5070) for any chemical application above 125°F (+52°C).

**TEMPERATURE:** -40°F to +275°F (-40°C to +135°C) continuous service.

**CONSTRUCTION:**  
**Tube:** Type J (CPE). Black.  
**Reinforcement:** Synthetic, high tensile textile with dual wire helix providing crush and kink resistance.  
**Cover:** Type P (EPDM). Brown corrugated with orange stripe.

**COUPLINGS:** Use 7, 8 or 49 for fluid temperatures to +125°F (+52°C). Use permanent fittings only 71 or 73 for fluid temperatures above +125°F (+52°C) and up to +212°F (+100°C). Reference the Hose Coupling Section.

AGRICULTURE

AIR BREATHING

AIR DUCT

AIR AND MULTI-PURPOSE

CHEMICAL

FOOD AND BEVERAGE

MARINE AND ENGINE

MATERIAL HANDLING

MINING

OILFIELD

PETROLEUM

PRESSURE WASH AND WASHDOWN

STEAM

WATER

CLAMPS

COUPLINGS AND FERRULES

HOSE FINDER

CHEMICAL RESISTANCE TABLE

## Chemical Hose

### Chem Master™ EPDM (125-150) SD Formerly - Colt®



AGRICULTURE
AIR BREATHING
AIR DUCT
AIR AND MULTI-PURPOSE
<b>CHEMICAL</b>
FOOD AND BEVERAGE
MARINE AND ENGINE
MATERIAL HANDLING
MINING
OILFIELD
PETROLEUM
PRESSURE WASH AND WASHDOWN
STEAM
WATER
CLAMPS
COUPLINGS AND FERRULES
HOSE FINDER
CHEMICAL RESISTANCE TABLE

Color	Hose I.D.		Hose O.D.		Max. W.P.		Vac.	MBR	Wt. Per ft	Length	Std. Pack	Pkg Code	Stock or MTO	Gates Item No.	List Price Per ft
	(in)	(mm)	(in)	(mm)	(psi)	(Bar)	(In. Hg)	(in)	(Lbs.)	(ft)			(ft)		
Yellow	3/4	19.1	1.27	32.3	150	10.3	30.0	3.0	.50	100	PLT	T	MTO	4696-0002	\$19.25
Yellow	1	25.4	1.52	38.6	150	10.3	30.0	3.5	.61	100	PLT	T	Stock	4696-0001	19.98
Yellow	1 1/4	31.8	1.79	45.5	150	10.3	30.0	4.0	.77	100	PLT	T	MTO	4696-0003	22.01
Yellow	1 1/4	31.8	1.79	45.5	150	10.3	30.0	4.0	.77	200	PLT	T	MTO	4696-0203	22.01
Yellow	1 1/2	38.1	2.04	51.8	150	10.3	30.0	5.0	.89	100	PLT	T	Stock	4696-0004	23.00
Yellow	2	50.8	2.54	64.5	150	10.3	30.0	6.0	1.07	100	PLT	T	Stock	4696-0005	25.68
Yellow	2 1/2	63.5	3.05	77.5	150	10.3	30.0	9.0	1.34	100	PLT	T	MTO	4696-0006	31.11
Yellow	3	76.2	3.60	91.4	150	10.3	30.0	11.0	1.70	100	PLT	T	Stock	4696-0009	37.28
Yellow	3	76.2	3.60	91.4	150	10.3	30.0	11.0	1.70	200	PLT	T	MTO	4696-0013	37.28
Yellow	4	101.6	4.60	116.8	150	10.3	30.0	16.0	2.25	100	PLT	T	Stock	4696-0012	47.10
Yellow	6	152.4	6.78	172.2	125	8.6	30.0	24.0	5.29	100	PLT	T	MTO	4696-0017	88.95

**RECOMMENDED FOR:** Tank truck, barge, ship, or storage tank transfer of a variety of mild chemical products. Chem Master™ EPDM contains a wire helix for full suction capability, as well as for routing hoses through tight bends. Its EPDM tube stock will withstand +250°F (+121°C) applications. Reference Gates Chemical Resistance Table for proper hose selection.

**CAUTION:** Chem Master™ EPDM is designed to withstand fluid temperatures to +250°F (+121°C); however the rating is dependent on the specific chemical conveyed. Contact Denver Product Application (303) 744-5070 for any chemical above +125°F (+52°C).

**TEMPERATURE:** -40°F to +250°F (-40°C to +121°C) normal service.

**CONSTRUCTION:**  
**Tube:** Type P (EPDM). Black. Mild chemical resistance.  
**Reinforcement:** Synthetic, high tensile textile with steel wire helix.  
**Cover:** Type P (EPDM). Yellow corrugated with orange stripe.  
**Design Factor:** 4:1

**COUPLINGS:** Use 7, 8, or 49 for fluid temperatures to +125°F (+52°C). Use permanent fittings only 71 or 73 for fluid temperatures above +125°F (+52°C) and up to +250°F (+121°C). Reference the Hose Coupling Section.

## Chemical Hose

### Chem Master™ Paint Spray (500-750)

Formerly - 77B



Color	Hose I.D.		Hose O.D.		Max. W.P.		Vac.	MBR	Wt. Per ft	Length	Std. Pack	Pkg Code	Stock or MTO (ft)	Gates Item No.	List Price Per ft
	(in)	(mm)	(in)	(mm)	(psi)	(Bar)									
Black	1/4	6.4	.52	13.2	500	34.5	30.0	3.0	.09	700	Reel	EE	Stock	3207-0290	\$3.74
Black	5/16	7.9	.59	15.0	500	34.5	30.0	3.0	.11	700	Reel	EE	MTO	3207-0291	4.40
Black	3/8	9.5	.67	17.0	500	34.5	30.0	3.0	.14	700	Reel	EE	Stock	3207-0292	5.12
Black	1/2	12.7	.87	22.1	750	51.7	25.0	5.0	.23	700	Reel	EE	Stock	3207-0294	7.47
Black	3/4	19.1	1.16	29.5	750	51.7	25.0	6.0	.35	350	Reel	KK	Stock	3207-0296	11.51

**RECOMMENDED FOR:** Paint spray applications, as well as transfer of petroleum-based products (aliphatic, aromatic and chlorinated hydrocarbon such as toluene, xylene, benzene, gasoline and carbon tetrachloride). Reference Gates Chemical Resistance Table for proper hose selection. Compatible with commercially available Bio-Diesel fuels up to B-100.

**CAUTION:** Contact Denver Product Application (303) 744-5070 when conveying chemicals above +120°F (+49°C). Not recommended for acids or use in high pressure paint spray applications requiring a static-conductive hose.

**TEMPERATURE:** -40°F to +150°F (-40°C to +66°C) continuous service.

**CONSTRUCTION:** **Tube:** Type Z (Special Flexible Nylon 11). Clear.  
**Reinforcement:** Synthetic, high tensile textile cord.  
**Cover:** Type A (Chloroprene). Black.  
**Design Factor:** 4:1

**COUPLINGS:** 48. For paint service: Binks 3 piece compression ring only. Reference the Hose Coupling Section.

AGRICULTURE

AIR BREATHING

AIR DUCT

AIR AND MULTI-PURPOSE

CHEMICAL

FOOD AND BEVERAGE

MARINE AND ENGINE

MATERIAL HANDLING

MINING

OILFIELD

PETROLEUM

PRESSURE WASH AND WASHDOWN

STEAM

WATER

CLAMPS

COUPLINGS AND FERRULES

HOSE FINDER

CHEMICAL RESISTANCE TABLE

## Chemical Hose

### Chem Master™ DEF Transfer 350 Formerly - Diesel Exhaust Fluid



Color	Hose I.D.	Hose O.D.	Max. W.P.	Vac.	MBR	Wt. Per ft	Length	Std. Pack	Pkg Code	Stock or MTO (ft)	Gates Item No.	List Price Per ft			
	(in)	(mm)	(in)	(mm)	(psi)	(Bar)	(In. Hg)						(in)	(Lbs.)	(ft)
Black	3/4	19.1	1.12	28.4	350	24.1	15.0	4.0	.32	550	Reel	GG	Stock	4217-0310	\$6.76
Black	1	25.4	1.36	34.5	350	24.1	10.0	6.0	1.00	400	Reel	CC	Stock	4217-0311	9.82

**RECOMMENDED FOR:** DEF dispensing tank fill hose. Transfer of urea solutions such as ADBLUE.

**TEMPERATURE:** -40°F to +212°F (-40°C to +100°C) continuous service.

**CONSTRUCTION:**  
**Tube:** Type P (EPDM). Black – Peroxide Cured – No Zinc.  
**Reinforcement:** Synthetic, high tensile textile cord.  
**Cover:** Type P (EPDM). Black with orange stripe. Wrapped appearance.  
**Design Factor:** 4:1

**COUPLINGS:** 75 Gates GLX® or 82 Gates SS. Reference the Hose Coupling Section.

**STANDARDS:** **Tube:** Zinc and Calcium Carbonate Free.

AGRICULTURE
AIR BREATHING
AIR DUCT
AIR AND MULTI-PURPOSE
CHEMICAL
FOOD AND BEVERAGE
MARINE AND ENGINE
MATERIAL HANDLING
MINING
OILFIELD
PETROLEUM
PRESSURE WASH AND WASHDOWN
STEAM
WATER
CLAMPS
COUPLINGS AND FERRULES
HOSE FINDER
CHEMICAL RESISTANCE TABLE

## Chemical Hose

### Chem Master™ Hydrocarbon Drain 250



Color	Hose I.D.		Hose O.D.		Max. W.P.		Vac.	MBR	Wt. Per ft	Length	Std. Pack	Pkg Code	Stock or MTO	Gates Item No.	List Price Per ft
	(in)	(mm)	(in)	(mm)	(psi)	(Bar)									
Tan	3/4	19.1	1.13	28.7	250	17.2	30.0	6.0	.42	500	Reel	UU	Stock	3624-0144	\$12.55

**RECOMMENDED FOR:** Drainage of hot liquid residue produced by the cleaning of storage tanks and containment vessels. Drainage of residue produced during the refining of hydrocarbons.

**TEMPERATURE:** -40°F to +300°F (-40°C to +150°C) continuous service.

**CONSTRUCTION:**  
**Tube:** Type C (Nitrile). Black.  
**Reinforcement:** Braided, high tensile steel wire.  
**Cover:** Type J (CPE). Tan with orange stripe.  
**Design Factor:** 4:1

**COUPLINGS:** 74 Gates MegaCrimp® couplings. Reference the Hose Coupling Section.

**STANDARDS:**  
**Tube:** ARPM (Class A) High oil-resistance.  
**Cover:** ARPM (Class B) Medium oil-resistance.

AGRICULTURE

AIR BREATHING

AIR DUCT

AIR AND MULTI-PURPOSE

CHEMICAL

FOOD AND BEVERAGE

MARINE AND ENGINE

MATERIAL HANDLING

MINING

OILFIELD

PETROLEUM

PRESSURE WASH AND WASHDOWN

STEAM

WATER

CLAMPS

COUPLINGS AND FERRULES

HOSE FINDER

CHEMICAL RESISTANCE TABLE



## Food and Beverage Hose

### Food Master® XTreme™ 250SD CR

Formerly - Food & Beverage Master®



AGRICULTURE
AIR BREATHING
AIR DUCT
AIR AND MULTI-PURPOSE
CHEMICAL
FOOD AND BEVERAGE
MARINE AND ENGINE
MATERIAL HANDLING
MINING
OILFIELD
PETROLEUM
PRESSURE WASH AND WASHDOWN
STEAM
WATER
CLAMPS
COUPLINGS AND FERRULES
HOSE FINDER
CHEMICAL RESISTANCE TABLE

Color	Hose I.D.		Hose O.D.		Max. W.P.		Vac.	MBR	Wt. Per ft	Length	Std. Pack	Pkg Code	Stock or MTO	Gates Item No.	List Price Per ft
	(in)	(mm)	(in)	(mm)	(psi)	(Bar)									
Gray	3/4	19.1	1.22	31.0	250	17.2	30.0	2.0	.42	100	PLT	T	MTO	3132-0263	\$32.61
Gray	1	25.4	1.48	37.6	250	17.2	30.0	3.0	.52	100	PLT	T	Stock	3132-0264	40.82
Gray	1 1/2	38.1	2.07	52.6	250	17.2	30.0	4.5	.90	100	PLT	T	Stock	3132-0265	46.31
Gray	1 1/2	38.1	2.07	52.6	250	17.2	30.0	4.5	.90	200	PLT	T	MTO	3132-0066	46.31
Gray	2	50.8	2.62	66.5	250	17.2	30.0	6.0	1.21	100	PLT	T	Stock	3132-0266	57.95
Gray	2 1/2	63.5	3.25	82.6	250	17.2	30.0	12.0	1.82	100	PLT	T	MTO	3132-0267	77.63
Gray	2 1/2	63.5	3.25	82.6	250	17.2	30.0	12.0	1.81	200	PLT	T	MTO	3132-0067	77.63
Gray	3	76.2	3.86	98.0	250	17.2	30.0	18.0	2.46	100	PLT	T	Stock	3132-0268	85.82
Gray	4	101.6	4.88	124.0	250	17.2	30.0	36.0	3.24	100	PLT	T	MTO	3132-0269	124.68
White	3/4	19.1	1.22	31.0	250	17.2	30.0	2.0	.42	100	PLT	T	Stock	3132-0222	32.61
White	1	25.4	1.48	37.6	250	17.2	30.0	3.0	.52	100	PLT	T	Stock	3132-0216	40.82
White	1 1/2	38.1	2.07	52.6	250	17.2	30.0	4.5	.90	100	PLT	T	Stock	3132-0217	46.31
White	2	50.8	2.62	66.5	250	17.2	30.0	6.0	1.19	100	PLT	T	Stock	3132-0218	57.95
White	2 1/2	63.5	3.25	82.6	250	17.2	30.0	12.0	1.82	100	PLT	T	Stock	3132-0219	77.63
White	3	76.2	3.86	98.0	250	17.2	30.0	18.0	2.47	100	PLT	T	Stock	3132-0220	85.82
White	4	101.6	4.88	124.0	250	17.2	30.0	36.0	3.24	100	PLT	T	Stock	3132-0221	124.68

**RECOMMENDED FOR:** Transfer of milk, juice, beer, soft drinks, pharmaceuticals, cosmetics or water-based products requiring a FDA sanitary hose. Also suitable for many dry bulk products via suction, pneumatic or gravity where a sanitary hose is required.

**TEMPERATURE:** -40°F to +230°F (-40°C to +110°C) continuous service.

**CONSTRUCTION:** **Tube:** Type S (Sanitron™). White.  
**Reinforcement:** Synthetic, high tensile textile with static-conductive filament; resilient monofilament helix providing crush and kink-resistance.

**Cover:** Type P (EPDM). White or gray with burgundy stripe. Additional color covers available on special order.

**Design Factor:** 4:1

**COUPLINGS:** 1 or stainless steel, 8 or stainless steel, 34, 71. Reference the Hose Coupling Section.

**STANDARDS:** Meets FDA requirements, 3A-Class 3 and USDA.

## Food and Beverage Hose

### Food Master® Beverage 250SD CR Formerly - Cellar Master®



Color	Hose I.D.		Hose O.D.		Max. W.P.		Vac.	MBR	Wt. Per ft	Length	Std. Pack	Pkg Code	Stock or MTO	Gates Item No.	List Price Per ft
	(in)	(mm)	(in)	(mm)	(psi)	(Bar)	(in. Hg)	(in)	(Lbs.)	(ft)			(ft)		
White	1	25.4	1.48	37.6	250	17.2	30.0	3.0	.52	100	PLT	T	MTO	3132-0180	\$40.82
White	1 1/2	38.1	2.07	52.6	250	17.2	30.0	4.5	.97	100	PLT	T	MTO	3132-0181	46.31
White	2	50.8	2.62	66.5	250	17.2	30.0	6.0	1.32	100	PLT	T	Stock	3132-0182	57.95
White	2 1/2	63.5	3.25	82.6	250	17.2	30.0	12.0	1.60	100	PLT	T	MTO	3132-0186	77.63
White	3	76.2	3.86	98.0	250	17.2	30.0	18.0	2.20	100	PLT	T	Stock	3132-0183	85.82
White	4	101.6	4.88	124.0	250	17.2	30.0	36.0	2.75	100	PLT	T	MTO	3132-0184	124.68

**RECOMMENDED FOR:** Transfer of milk, juice, beer, soft drinks, pharmaceuticals, cosmetics or water-based products requiring a FDA sanitary hose.

**TEMPERATURE:** -40°F to +230°F (-40°C to +110°C) continuous service.

**CONSTRUCTION:**  
**Tube:** Type S (Sanitron™). White.  
**Reinforcement:** Synthetic, high tensile textile with resilient monofilament helix providing crush and kink-resistance.  
**Cover:** Type P (EPDM). White with burgundy stripe.  
**Design Factor:** 4:1

**COUPLINGS:** 1 or stainless steel, 8 or stainless steel, 34, 71. Reference the Hose Coupling Section.

**STANDARDS:** Meets FDA requirements, 3A-Class 3 and USDA.

AGRICULTURE

AIR BREATHING

AIR DUCT

AIR AND MULTI-PURPOSE

CHEMICAL

FOOD AND BEVERAGE

MARINE AND ENGINE

MATERIAL HANDLING

MINING

OILFIELD

PETROLEUM

PRESSURE WASH AND WASHDOWN

STEAM

WATER

CLAMPS

COUPLINGS AND FERRULES

HOSE FINDER

CHEMICAL RESISTANCE TABLE

## Food and Beverage Hose

### Food Master® Beverage 150SD CR

Formerly - Cellar Master® Light



AGRICULTURE
AIR BREATHING
AIR DUCT
AIR AND MULTI-PURPOSE
CHEMICAL
FOOD AND BEVERAGE
MARINE AND ENGINE
MATERIAL HANDLING
MINING
OILFIELD
PETROLEUM
PRESSURE WASH AND WASHDOWN
STEAM
WATER
CLAMPS
COUPLINGS AND FERRULES
HOSE FINDER
CHEMICAL RESISTANCE TABLE

Color	Hose I.D.		Hose O.D.		Max. W.P.		Vac.	MBR	Wt. Per ft	Length	Std. Pack	Pkg Code	Stock or MTO	Gates Item No.	List Price Per ft
	(in)	(mm)	(in)	(mm)	(psi)	(Bar)	(In. Hg)	(in)	(Lbs.)	(ft)			(ft)		
Gray	1 1/2	38.1	2.00	50.8	150	10.3	30.0	6.0	.65	100	PLT	T	MTO	3132-0171	\$41.69
Gray	2	50.8	2.50	63.5	150	10.3	30.0	12.0	.96	100	PLT	T	Stock	3132-0172	52.16
Gray	2 1/2	63.5	3.11	79.0	150	10.3	30.0	22.0	1.62	100	PLT	T	MTO	3132-0173	69.87
Gray	3	76.2	3.75	95.3	150	10.3	30.0	20.0	2.13	100	PLT	T	MTO	3132-0174	77.24
Gray	4	101.6	4.76	120.9	150	10.3	30.0	28.0	3.16	100	PLT	T	MTO	3132-0175	112.22

**RECOMMENDED FOR:** Transfer of milk, juice, beer, soft drinks, pharmaceuticals, cosmetics or water-based products requiring a FDA sanitary hose.

**TEMPERATURE:** -40°F to +212°F (-40°C to +100°C) continuous service.

**CONSTRUCTION:**  
**Tube:** Type S (Sanitron™). White.  
**Reinforcement:** Synthetic, high tensile textile with resilient monofilament helix providing crush and kink-resistance.  
**Cover:** Type P (EPDM). Gray with burgundy stripe. Corrugated abrasion resistant UHMW cover option available.  
**Design Factor:** 4:1

**COUPLINGS:** 1 or stainless steel, 8 or stainless steel, 34, 71. Reference the Hose Coupling Section.

**STANDARDS:** Meets FDA requirements, 3A-Class 3 and USDA.

## Food and Beverage Hose

### Food Master® Oils and Dairy 150SD Formerly - Food Master® Lite™



Color	Hose I.D.		Hose O.D.		Max. W.P.		Vac.	MBR	Wt. Per ft	Length	Std. Pack	Pkg Code	Stock or MTO	Gates Item No.	List Price Per ft
	(in)		(in)		(mm)		(mm)	(psi)	(Bar)	(In. Hg)			(in)		
White	3/4	19.1	1.29	32.8	150	10.3	30.0	2.0	.65	100	PLT	T	Stock	3133-0001	\$19.91
White	3/4	19.1	1.29	32.8	150	10.3	30.0	2.0	.64	200	PLT	T	MTO	3133-0011	19.91
White	1	25.4	1.54	39.1	150	10.3	30.0	3.0	.79	100	PLT	T	Stock	3133-0002	24.63
White	1 1/2	38.1	2.05	52.1	150	10.3	30.0	4.5	1.15	100	PLT	T	Stock	3133-0003	29.15
White	2	50.8	2.55	64.8	150	10.3	30.0	6.0	1.50	100	PLT	T	Stock	3133-0004	41.27
White	2 1/2	63.5	3.08	78.2	150	10.3	30.0	12.0	1.98	100	PLT	T	Stock	3133-0005	53.97
White	3	76.2	3.58	90.9	150	10.3	30.0	18.0	2.35	100	PLT	T	Stock	3133-0006	59.00
White	4	101.6	4.60	116.8	150	10.3	30.0	24.0	3.12	100	PLT	T	Stock	3133-0007	73.91
White	4	101.6	4.60	116.8	150	10.3	30.0	18.0	3.13	200	PLT	T	MTO	3133-0055	73.91
White	6	152.4	6.69	169.9	150	10.3	30.0	36.0	5.59	50	PLT	T	Stock	3133-0008	116.27

**RECOMMENDED FOR:** Tank truck, barge, ship, or storage tank transfer of a variety of food products such as animal fat, vegetable oil and other edible oils at temperatures up to +230°F requiring FDA sanitary hose. Also suitable for ice cream and other dairy products requiring 3A–Class 3 standards.

**TEMPERATURE:** –40°F to +230°F (–40°C to +110°C) continuous service.

**CONSTRUCTION:** **Tube:** Type C2 (Modified Nitrile). Sanitary FDA and 3A–Class 3. White.  
**Reinforcement:** Synthetic, high tensile textile with steel wire helix.  
**Cover:** Type C2 (Modified Nitrile). White corrugated with burgundy stripe.  
**Design Factor:** 4:1

**COUPLINGS:** 1 or stainless steel, 8 or stainless steel, 34, 71. Reference the Hose Coupling Section.

**STANDARDS:** Tube meets FDA requirements, 3A–Class 3 and USDA. Phthalate free.

AGRICULTURE

AIR BREATHING

AIR DUCT

AIR AND MULTI-PURPOSE

CHEMICAL

FOOD AND BEVERAGE

MARINE AND ENGINE

MATERIAL HANDLING

MINING

OILFIELD

PETROLEUM

PRESSURE WASH AND WASHDOWN

STEAM

WATER

CLAMPS

COUPLINGS AND FERRULES

HOSE FINDER

CHEMICAL RESISTANCE TABLE

## Food and Beverage Hose

### Food Master® Oils and Dairy 150D Formerly - Sani-Pure™

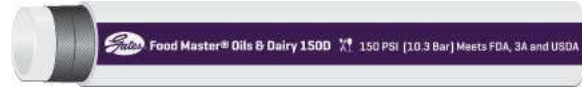

AGRICULTURE
AIR BREATHING
AIR DUCT
AIR AND MULTI-PURPOSE
CHEMICAL
FOOD AND BEVERAGE
MARINE AND ENGINE
MATERIAL HANDLING
MINING
OILFIELD
PETROLEUM
PRESSURE WASH AND WASHDOWN
STEAM
WATER
CLAMPS
COUPLINGS AND FERRULES
HOSE FINDER
CHEMICAL RESISTANCE TABLE

Color	Hose I.D.		Hose O.D.		Max. W.P. (psi)	Max. W.P. (Bar)	Vac. (In. Hg)	MBR (in)	Wt. Per ft (Lbs.)	Length (ft)	Std. Pack	Pkg Code	Stock or MTO (ft)	Gates Item No.	List Price Per ft
	(in)	(mm)	(in)	(mm)											
White	1 1/2	38.1	2.04	51.8	150	10.3	—	18.0	.97	100	PLT	T	MTO	3131-0001	\$26.85
White	2	50.8	2.54	64.5	150	10.3	—	24.0	1.25	100	PLT	T	Stock	3131-0002	33.08
White	2 1/2	63.5	3.06	77.7	150	10.3	—	30.0	1.66	100	PLT	T	MTO	3131-0003	42.24
White	3	76.2	3.56	90.4	150	10.3	—	36.0	1.90	100	PLT	T	MTO	3131-0004	47.69
White	4	101.6	4.60	116.8	150	10.3	—	48.0	2.78	100	PLT	T	MTO	3131-0005	67.88
White	6	152.4	6.60	167.6	150	10.3	—	72.0	4.10	50	PLT	T	MTO	3131-0006	108.41

**RECOMMENDED FOR:** Tank truck, barge, ship, or storage tank transfer (discharge only) of a variety of food products such as animal fat, vegetable oil and other edible oils at temperatures up to +230°F requiring FDA sanitary hose. Also suitable for ice cream and other dairy products requiring 3A–Class 3 standards.

**TEMPERATURE:** –40°F to +230°F (–40°C to +110°C) continuous service.

**CONSTRUCTION:**  
**Tube:** Type C2 (Modified Nitrile). Sanitary FDA and 3A–Class 3. White.  
**Reinforcement:** Synthetic, high tensile textile.  
**Cover:** Type C2 (Modified Nitrile). White with burgundy stripe.  
**Design Factor:** 4:1

**COUPLINGS:** 1 or stainless steel, 8 or stainless steel, 34, 71. Reference the Hose Coupling Section.

**STANDARDS:** Tube meets FDA requirements, 3A–Class 3 and USDA. Phthalate free.

## Food and Beverage Hose

### Food Master® Oils and Dairy 150SD MegaFlex®



Color	Hose I.D.		Hose O.D.		Max. W.P.		Vac.	MBR	Wt. Per ft	Length	Std. Pack	Pkg Code	Stock or MTO	Gates Item No.	List Price Per ft
	(in)	(mm)	(in)	(mm)	(psi)	(Bar)									
White	1	25.4	1.47	37.3	150	10.3	30.0	2.0	.58	100	PLT	T	Stock	3133-0100	\$27.09
White	1 1/2	38.1	1.99	50.5	150	10.3	30.0	3.0	.87	100	PLT	T	Stock	3133-0101	32.07
White	2	50.8	2.49	63.2	150	10.3	30.0	4.0	1.14	100	PLT	T	Stock	3133-0102	45.40
White	3	76.2	3.56	90.4	150	10.3	30.0	9.0	1.92	100	PLT	T	Stock	3133-0103	64.90
White	4	101.6	4.73	120.1	150	10.3	30.0	12.0	3.07	100	PLT	T	Stock	3133-0104	81.30

**RECOMMENDED FOR:** Tank truck, barge, ship, or storage tank transfer of a variety of food products such as animal fat, vegetable oil, and other edible oils at temperatures up to +230°F requiring FDA sanitary hose. Also suitable for ice cream and other dairy products requiring 3A-Class 3 standards.

**TEMPERATURE:** -40°F to +230°F (-40°C to +110°C) continuous service.

**CONSTRUCTION:**  
**Tube:** Type C2 (Modified Nitrile). Sanitary FDA and 3A-Class 3. Phthalate free. White.  
**Reinforcement:** Synthetic, high tensile textile with steel helix providing crush and kink-resistance.  
**Cover:** Type C2 (Modified Nitrile). Sanitary FDA and 3A-Class 3. Phthalate free. White with burgundy stripe.  
**Design Factor:** 4:1

**COUPLINGS:** 1 or stainless steel, 8 or stainless steel, 34, 71. Reference the Hose Coupling Section.

**STANDARDS:** Meets FDA requirements, 3A-Class 3.

AGRICULTURE

AIR BREATHING

AIR DUCT

AIR AND MULTI-PURPOSE

CHEMICAL

FOOD AND BEVERAGE

MARINE AND ENGINE

MATERIAL HANDLING

MINING

OILFIELD

PETROLEUM

PRESSURE WASH AND WASHDOWN

STEAM

WATER

CLAMPS

COUPLINGS AND FERRULES

HOSE FINDER

CHEMICAL RESISTANCE TABLE

## Food and Beverage Hose

### Food Master® Dry Goods (50-150) SD Formerly - 690SB



AGRICULTURE
AIR BREATHING
AIR DUCT
AIR AND MULTI-PURPOSE
CHEMICAL
FOOD AND BEVERAGE
MARINE AND ENGINE
MATERIAL HANDLING
MINING
OILFIELD
PETROLEUM
PRESSURE WASH AND WASHDOWN
STEAM
WATER
CLAMPS
COUPLINGS AND FERRULES
HOSE FINDER
CHEMICAL RESISTANCE TABLE

Color	Hose I.D.		Hose O.D.		Max. W.P.		Vac.	MBR	Wt. Per ft	Length	Std. Pack	Pkg Code	Stock or MTO	Gates Item No.	List Price Per ft
	(in)	(mm)	(in)	(mm)	(psi)	(Bar)	(In. Hg)	(in)	(Lbs.)	(ft)			(ft)		
Gray	1 1/2	38.1	2.23	56.6	150	10.3	30.0	10.0	1.24	100	PLT	T	MTO	4693-0205	\$31.05
Gray	2	50.8	2.75	69.9	150	10.3	30.0	12.0	1.76	100	PLT	T	Stock	4693-0210	40.05
Gray	2 1/2	63.5	3.23	82.0	125	8.6	30.0	15.0	2.00	100	PLT	T	MTO	4693-0220	47.79
Gray	3	76.2	3.75	95.3	100	6.9	30.0	18.0	2.13	100	PLT	T	Stock	4693-0225	54.00
Gray	4	101.6	4.71	119.6	75	5.2	30.0	24.0	3.00	100	PLT	T	Stock	4693-0235	64.77
Gray	5	127.0	5.75	146.1	55	3.8	30.0	30.0	3.98	50	PLT	T	Stock	4693-0251	87.59
Gray	5	127.0	5.75	146.1	55	3.8	30.0	30.0	4.30	100	PLT	T	MTO	4693-0001	91.97
Gray	6	152.4	6.91	175.5	50	3.4	30.0	36.0	5.88	50	PLT	T	Stock	4693-0260	106.44
Gray	6	152.4	6.91	175.5	50	3.4	30.0	36.0	5.88	100	PLT	T	MTO	4693-0262	106.44

**RECOMMENDED FOR:** Transfer of bulk food products via suction, pneumatic or gravity systems where FDA sanitary tube is required. Examples: Flour, sugar, syrup and edible grains.

**CAUTION:** Not recommended for vinegar, mustard or other compounds containing acetic acid.

**TEMPERATURE:** -40°F to +150°F (-40°C to +66°C) continuous service.

**CONSTRUCTION:** **Tube:** Type D2 (Natural Rubber). Sanitary FDA. White. 3/16" thick.  
**Reinforcement:** Synthetic, high tensile textile with steel wire helix.  
**Cover:** Type P (EPDM). Gray corrugated with burgundy stripe.  
**Design Factor:** 4:1

**COUPLINGS:** 5\*, 6\*, 7\*, 8, 49 or 71. Reference the Hose Coupling Section. \*Can be used only at 50% of rated working pressure.

**STANDARDS:** Tube meets FDA requirements.



## Food and Beverage Hose

### Food Master® Dry Goods (25-40) D Formerly - 610W



Color	Hose I.D.		Hose O.D.		Max. W.P.		Vac.	MBR	Wt. Per ft	Length	Std. Pack	Pkg Code	Stock or MTO	Gates Item No.	List Price Per ft
	(in)	(mm)	(in)	(mm)	(psi)	(Bar)	(In. Hg)	(in)	(Lbs.)	(ft)			(ft)		
Gray	4	101.6	4.56	115.8	40	2.8	—	48.0	2.08	100	PLT	T	Stock	3132-0782	\$55.01
Gray	5	127.0	5.56	141.2	30	2.1	—	60.0	2.46	100	PLT	T	Stock	3132-0793	70.77
Gray	6	152.4	6.56	166.6	25	1.7	—	72.0	3.04	100	PLT	T	Stock	3132-0797	86.45
Yellow	4	101.6	4.56	115.8	40	2.8	—	48.0	2.22	100	PLT	T	MTO	3132-0783	60.51
Yellow	5	127.0	5.56	141.2	30	2.1	—	60.0	2.73	100	PLT	T	MTO	3132-0794	77.85

**RECOMMENDED FOR:** Pneumatic transfer of flour and other dry foods requiring hose with a sanitary FDA tube.

**TEMPERATURE:** -40°F to +150°F (-40°C to +66°C) continuous service.

**CONSTRUCTION:** **Tube:** Type D2 (Natural Rubber). Sanitary FDA. White. 3/16" thick.  
**Reinforcement:** Synthetic, high tensile textile with carbon fiber conductor.  
**Cover:** Type C4 (Carboxylated Nitrile). Yellow with burgundy stripe.  
 Type D3 (Natural Rubber). Gray with burgundy stripe.  
**Design Factor:** 4:1

**COUPLINGS:** 5, 7, 49 or 71. Reference the Hose Coupling Section.

**STANDARDS:** Tube meets FDA requirements.

AGRICULTURE

AIR BREATHING

AIR DUCT

AIR AND MULTI-PURPOSE

CHEMICAL

FOOD AND BEVERAGE

MARINE AND ENGINE

MATERIAL HANDLING

MINING

OILFIELD

PETROLEUM

PRESSURE WASH AND WASHDOWN

STEAM

WATER

CLAMPS

COUPLINGS AND FERRULES

HOSE FINDER

CHEMICAL RESISTANCE TABLE

## Food and Beverage Hose

### Food Master® PVC (20-65) Clear



AGRICULTURE
AIR BREATHING
AIR DUCT
AIR AND MULTI-PURPOSE
CHEMICAL
FOOD AND BEVERAGE
MARINE AND ENGINE
MATERIAL HANDLING
MINING
OILFIELD
PETROLEUM
PRESSURE WASH AND WASHDOWN
STEAM
WATER
CLAMPS
COUPLINGS AND FERRULES
HOSE FINDER
CHEMICAL RESISTANCE TABLE

Color	Hose I.D.	Hose O.D.	Max. W.P.*	Vac.*	MBR	Wt. Per ft	Length	Std. Pack	Pkg Code	Stock or MTO	Gates Item No.	List Price Per ft			
	(in)	(mm)											(in)	(mm)	(psi)
Clear	1/8	3.2	.20	4.8	65	4.5	—	—	.02	100	Ctn	T	Stock	7744-1512	\$.40
Clear	3/16	4.8	.25	6.4	50	3.4	—	—	.03	100	Ctn	T	Stock	7744-1513	.37
Clear	3/16	4.8	.38	9.7	60	4.1	—	—	.04	100	Ctn	T	Stock	7744-1514	.67
Clear	1/4	6.4	.38	9.7	55	3.8	—	—	.03	100	Ctn	T	Stock	7744-1515	.47
Clear	1/4	6.4	.50	12.7	60	4.1	—	—	.08	100	Ctn	T	Stock	7744-1516	1.04
Clear	5/16	7.9	.44	11.2	50	3.4	—	—	.04	100	Ctn	T	Stock	7744-1517	.53
Clear	5/16	7.9	.56	14.2	60	4.1	—	—	.10	100	Ctn	T	Stock	7744-1518	1.18
Clear	3/8	9.5	.50	12.7	45	3.1	—	—	.06	100	Ctn	T	Stock	7744-1519	.60
Clear	3/8	9.5	.63	16.0	55	3.8	—	—	.12	100	Ctn	T	Stock	7744-1520	1.18
Clear	1/2	12.7	.63	16.0	30	2.1	—	—	.07	100	Ctn	T	Stock	7744-1521	.87
Clear	1/2	12.7	.75	19.1	45	3.1	—	—	.13	100	Ctn	T	Stock	7744-1522	1.51
Clear	5/8	15.9	.75	19.1	25	1.7	—	—	.08	100	Ctn	T	Stock	7744-1523	1.07
Clear	5/8	15.9	.88	22.4	40	2.8	—	—	.16	100	Ctn	T	Stock	7744-1524	1.81
Clear	3/4	19.1	1.00	25.4	35	2.4	—	—	.19	100	Ctn	T	Stock	7744-1525	2.01
Clear	3/4	19.1	1.25	31.8	45	3.1	—	—	.43	100	Ctn	T	Stock	7744-1526	5.74
Clear	1	25.4	1.25	31.8	25	1.7	—	—	.21	100	Ctn	T	Stock	7744-1527	2.95
Clear	1	25.4	1.50	38.1	35	2.4	—	—	.54	100	Ctn	T	Stock	7744-1528	7.15
Clear	1 1/4	31.8	1.50	38.1	20	1.4	—	—	.28	50	PLT	T	Stock	7744-1529	3.63
Clear	1 1/4	31.8	1.75	44.5	40	2.8	—	—	.67	50	PLT	T	Stock	7744-1530	9.23
Clear	1 1/2	38.1	2.00	50.8	35	2.4	—	—	.85	50	PLT	T	Stock	7744-1531	9.60
Clear	2	50.8	2.50	63.5	35	2.4	—	—	.85	50	PLT	T	Stock	7744-1532	12.32

NOTE: \* Working Pressure and Vacuum at +72°F (+22°C).

**RECOMMENDED FOR:** This hose has good oil-resistance, excellent resistance to acids, alkalis, and many solvents except esters, ketones and aromatic hydrocarbons. Formulated to meet applicable FDA criteria.

**TEMPERATURE:** -25°F to +150°F (-31°C to +65°C) continuous service.

**CONSTRUCTION:** **Tube:** Type G (PVC). Non-toxic. Clear. Phthalate-Free.  
**Reinforcement:** None.  
**Cover:** Type G (PVC). Non-toxic. Clear. Smooth.

**COUPLINGS:** 19 or stainless steel. Reference the Hose Coupling Section.

**STANDARDS:** Meets applicable FDA.

## Food and Beverage Hose

### Food Master® PVC Clear Tubing (75-250) Braid

Formerly - Tufflex® Food



Color	Hose I.D.		Hose O.D.		Max. W.P.*		Vac.*	MBR	Wt. Per ft	Length	Std. Pack	Pkg Code	Stock or MTO	Gates Item No.	List Price Per ft
	(in)	(mm)	(in)	(mm)	(psi)	(Bar)									
Clear	1/4	6.4	.47	11.9	250	17.2	—	—	.07	300	PLT	T	Stock	7744-4501	\$1.17
Clear	3/8	9.5	.63	16.0	200	13.8	—	—	.11	300	PLT	T	Stock	7744-4502	1.58
Clear	1/2	12.7	.75	19.1	200	13.8	—	—	.13	300	PLT	T	Stock	7744-4503	1.88
Clear	5/8	15.9	.88	22.4	200	13.8	—	—	.15	300	PLT	T	Stock	7744-4504	2.40
Clear	3/4	19.1	1.03	26.2	150	10.3	—	—	.20	300	PLT	T	Stock	7744-4505	2.82
Clear	1	25.4	1.31	33.3	125	8.6	—	—	.32	100	PLT	T	Stock	7744-4506	4.70
Clear	1 1/4	31.8	1.75	44.5	100	6.9	—	—	.63	100	PLT	T	Stock	7744-4507	8.49
Clear	1 1/2	38.1	2.00	50.8	75	5.2	—	—	.74	100	PLT	T	Stock	7744-4508	11.13
Clear	2	50.8	2.50	63.5	75	5.2	—	—	1.00	100	PLT	T	Stock	7744-4509	15.53

NOTE: \* Working Pressure and Vacuum at +72°F (+22°C).

**RECOMMENDED FOR:** Transferring compressed liquid and air in food and beverage applications. Approved for use in USDA meat and poultry plants. Non-toxic, FDA formula approved for food processing. Also suitable for potable water transfer.

**TEMPERATURE:** -10°F to +130°F (-23°C to +55°C) continuous service.

**CONSTRUCTION:**  
**Tube:** Type G (PVC). Non-toxic. Clear.  
**Reinforcement:** Synthetic reinforcement.  
**Cover:** Type G (PVC). Non-toxic. Clear. Smooth.  
**Design Factor:** 4:1

**COUPLINGS:** Stainless Steel Food Grade.

**STANDARDS:** Meets FDA requirements and USDA.

AGRICULTURE

AIR BREATHING

AIR DUCT

AIR AND MULTI-PURPOSE

CHEMICAL

FOOD AND BEVERAGE

MARINE AND ENGINE

MATERIAL HANDLING

MINING

OILFIELD

PETROLEUM

PRESSURE WASH AND WASHDOWN

STEAM

WATER

CLAMPS

COUPLINGS AND FERRULES

HOSE FINDER

CHEMICAL RESISTANCE TABLE

## Food and Beverage Hose

### Food Master® PVC (50-100) SD Clear Formerly - Master-Flex® 200CL



AGRICULTURE
AIR BREATHING
AIR DUCT
AIR AND MULTI-PURPOSE
CHEMICAL
<b>FOOD AND BEVERAGE</b>
MARINE AND ENGINE
MATERIAL HANDLING
MINING
OILFIELD
PETROLEUM
PRESSURE WASH AND WASHDOWN
STEAM
WATER
CLAMPS
COUPLINGS AND FERRULES
HOSE FINDER
CHEMICAL RESISTANCE TABLE

Color	Hose I.D.		Hose O.D.		Max. W.P.*		Vac.*	MBR	Wt. Per ft	Length	Std. Pack	Pkg Code	Stock or MTO	Gates Item No.	List Price Per ft
	(in)	(mm)	(in)	(mm)	(psi)	(Bar)									
Clear	1	25.4	1.29	32.8	100	6.9	28.0	3.0	.30	100	PLT	T	Stock	7744-4101	\$5.46
Clear	1 1/4	31.8	1.56	39.6	90	6.2	28.0	4.0	.38	100	PLT	T	Stock	7744-4102	6.92
Clear	1 1/2	38.1	1.84	46.7	90	6.2	28.0	5.0	.48	100	PLT	T	MTO	7744-4103	7.56
Clear	2	50.8	2.39	60.7	70	4.8	28.0	6.0	.71	100	PLT	T	MTO	7744-4104	11.52
Clear	2 1/2	63.5	2.92	74.2	65	4.5	28.0	8.0	.97	100	PLT	T	Stock	7744-4105	16.44
Clear	3	76.2	3.46	87.9	60	4.1	28.0	9.0	1.27	100	PLT	T	Stock	7744-4106	20.99
Clear	4	101.6	4.56	115.8	50	3.4	28.0	12.0	2.00	100	PLT	T	MTO	7744-4107	36.11

NOTE: \* Working Pressure and Vacuum at +72°F (+22°C).

**RECOMMENDED FOR:** Transfer of bulk food products via suction, pneumatic or gravity systems where sanitary hose is required.

**TEMPERATURE:** -10°F to +130°F (-23°C to +55°C) continuous service.

**CONSTRUCTION:**  
**Tube:** Type G (PVC). Sanitary FDA. Clear. Smooth.  
**Reinforcement:** Rigid thermoplastic reinforcement. Clear.  
**Cover:** Type G (PVC). Sanitary FDA. Clear. Smooth.  
**Design Factor:** 3:1

**COUPLINGS:** 1, 6, 7 or 49. Reference the Hose Coupling Section.

**STANDARDS:** Meets FDA requirements, 3A-Class 3 and USDA.

## Food and Beverage Hose

### Food Master® PVC (35-50) SD Clear

Formerly - Master-Flex® 201CR



Color	Hose I.D.		Hose O.D.		Max. W.P.*		Vac.*	MBR	Wt. Per ft	Length	Std. Pack	Pkg Code	Stock or MTO	Gates Item No.	List Price Per ft
	(in)	(mm)	(in)	(mm)	(psi)	(Bar)	(In. Hg)	(in)	(Lbs.)	(ft)			(ft)		
Clear	1	25.4	1.26	32.0	40	2.8	28.0	2.0	.14	100	PLT	T	Stock	7744-4301	\$4.98
Clear	1 1/4	31.8	1.61	40.9	50	3.4	28.0	3.0	.28	100	PLT	T	Stock	7744-4302	5.39
Clear	1 1/2	38.1	1.82	46.2	50	3.4	28.0	3.0	.37	100	PLT	T	MTO	7744-4303	6.33
Clear	2	50.8	2.44	62.0	40	2.8	28.0	4.0	.57	100	PLT	T	MTO	7744-4304	8.73
Clear	2 1/2	63.5	2.98	75.7	40	2.8	28.0	5.0	.77	100	PLT	T	MTO	7744-4305	14.07
Clear	3	76.2	3.54	89.9	35	2.4	28.0	6.0	1.04	100	PLT	T	MTO	7744-4306	18.17
Clear	4	101.6	4.65	118.1	35	2.4	28.0	8.0	1.65	100	PLT	T	Stock	7744-4307	33.11

NOTE: \* Working Pressure and Vacuum at +72°F (+22°C).

**RECOMMENDED FOR:** Transfer of bulk food products via suction, pneumatic or gravity systems where sanitary hose is required.

**TEMPERATURE:** -10°F to +130°F (-23°C to +55°C) continuous service.

**CONSTRUCTION:** **Tube:** Type G (PVC). Sanitary FDA. Clear. Smooth.  
**Reinforcement:** Rigid thermoplastic helix. Clear.  
**Cover:** Type G (PVC). Sanitary FDA. Clear. Corrugated.  
**Design Factor:** 3:1

**COUPLINGS:** 1, 6, 7 or 49. Reference the Hose Coupling Section.

**STANDARDS:** Meets FDA requirements and USDA.

AGRICULTURE

AIR BREATHING

AIR DUCT

AIR AND MULTI-PURPOSE

CHEMICAL

FOOD AND BEVERAGE

MARINE AND ENGINE

MATERIAL HANDLING

MINING

OILFIELD

PETROLEUM

PRESSURE WASH AND WASHDOWN

STEAM

WATER

CLAMPS

COUPLINGS AND FERRULES

HOSE FINDER

CHEMICAL RESISTANCE TABLE

## Food and Beverage Hose

### Food Master® PVC Dry Goods (35-40) SD Clear Formerly - Master-Flex® 202SW



AGRICULTURE
AIR BREATHING
AIR DUCT
AIR AND MULTI-PURPOSE
CHEMICAL
<b>FOOD AND BEVERAGE</b>
MARINE AND ENGINE
MATERIAL HANDLING
MINING
OILFIELD
PETROLEUM
PRESSURE WASH AND WASHDOWN
STEAM
WATER
CLAMPS
COUPLINGS AND FERRULES
HOSE FINDER
CHEMICAL RESISTANCE TABLE

Color	Hose I.D.	Hose O.D.	Max. W.P.*	Vac.*	MBR	Wt. Per ft	Length	Std. Pack	Pkg Code	Stock or MTO	Gates Item No.	List Price Per ft			
	(in)	(mm)											(in)	(mm)	(psi)
Clear	2	50.8	2.37	60.2	40	2.8	28.0	4.0	.58	100	PLT	T	Stock	7744-4420	\$16.29
Clear	2 1/2	63.5	3.01	76.5	40	2.8	28.0	4.0	.85	100	PLT	T	MTO	7744-4425	21.39
Clear	3	76.2	3.62	91.9	35	2.4	28.0	6.0	1.02	100	PLT	T	MTO	7744-4430	28.53
Clear	4	101.6	4.54	115.3	35	2.4	28.0	8.0	1.36	100	PLT	T	Stock	7744-4440	40.91

NOTE: \* Working Pressure and Vacuum at +72°F (+22°C).

**RECOMMENDED FOR:** Transfer of bulk food products via suction, pneumatic or gravity systems where sanitary hose is required. Used in pneumatic conveying systems for powders, pellets or granular materials where a static-conductive hose is needed.

**TEMPERATURE:** -10°F to +130°F (-23°C to +55°C) continuous service.

**CONSTRUCTION:**  
**Tube:** Type G (PVC). Sanitary FDA. Clear. Smooth.  
**Reinforcement:** Rigid thermoplastic helix. Clear. Embedded static wire to prevent a buildup of static electricity.  
**Cover:** Type G (PVC). Sanitary FDA. Clear. Corrugated.  
**Design Factor:** 3:1

**COUPLINGS:** 1, 6, 7 or 49. Reference the Hose Coupling Section.

**STANDARDS:** Meets FDA requirements and USDA.

## Marine and Engine Hose

### 4219BG Barricade® Fuel Hose (35-50)

Formerly - Barricade® Carbureted Engines



Color	Hose I.D.		Hose O.D.		Max. W.P.		Vac.	MBR	Wt. Per ft	Length	Std. Pack	Pkg Code	Stock or MTO (ft)	Gates Item No.	List Price Per ft
	(in)		(mm)		(in)										
Black	3/16	4.8	.41	10.4	50	3.4	24.0	2.17	.07	550	Reel	TT	Stock	4219-5520	\$2.52
Black	1/4	6.4	.50	12.7	50	3.4	24.0	2.56	.11	550	Reel	TT	Stock	4219-5521	2.63
Black	5/16	7.9	.56	14.2	50	3.4	24.0	2.95	.11	550	Reel	TT	Stock	4219-5522	2.95
Black	3/8	9.5	.62	15.7	50	3.4	24.0	3.35	.12	550	Reel	TT	Stock	4219-5523	3.29
Black	1/2	12.7	.78	19.8	35	2.4	10.0	4.72	.13	550	Reel	TT	Stock	4219-5524	4.88

**RECOMMENDED FOR:** Carbureted engines in cars, light trucks, off-road vehicles and small engines where a barrier fuel hose is required. Gasoline, Gasoline/Ethanol (E10, E15, E85), 100% Methanol only (Methanol blends not recommended). Diesel, Diesel/Bio-Diesel blends, 100% Bio-Diesel (SME, RME, and PME Bio-Diesels are acceptable).

**CAUTION:** Not for fuel injections systems. (see 4219BF).

**TEMPERATURE:** -40°F to +212°F (-40°C to +100°C). For Bio-Diesel use (up to B100).  
-40°F to +257°F (-40°C to +125°C) continuous service. (Does not apply for Bio-Diesel use).

**CONSTRUCTION:** **Tube:** Type C (Nitrile). Fuel resistant, synthetic rubber, black, with thermoplastic barrier.  
**Reinforcement:** Spiral textile.  
**Cover:** Type C2 (Modified Nitrile). Synthetic rubber.  
**Design Factor:** 5:1

**COUPLINGS:** 75 Gates GLX®, GLP, beaded end with clamp, aluminum crimp ferrules with GC stem, and SAE J2044 quick-connect stems (barb must be suitable for rubber hose). Reference the Hose Coupling Section.

**STANDARDS:** CARB small engine off-road (CARB certificate Q-09-019).  
Meets SAE J30R14T1.

AGRICULTURE

AIR BREATHING

AIR DUCT

AIR AND MULTI-PURPOSE

CHEMICAL

FOOD AND BEVERAGE

MARINE AND ENGINE

MATERIAL HANDLING

MINING

OILFIELD

PETROLEUM

PRESSURE WASH AND WASHDOWN

STEAM

WATER

CLAMPS

COUPLINGS AND FERRULES

HOSE FINDER



CHEMICAL RESISTANCE TABLE



## Marine and Engine Hose

### 4219BF Barricade® Fuel Injection Fuel Hose 225



Color	Hose I.D.		Hose O.D.		Max. W.P.		Vac.	MBR	Wt. Per ft	Length	Std. Pack	Pkg Code	Stock or MTO	Gates Item No.	List Price Per ft
	(in)	(mm)	(in)	(mm)	(psi)	(Bar)	(In. Hg)	(in)	(Lbs.)	(ft)			(ft)		
Black	1/4	6.4	.50	12.7	225	15.5	24.0	2.56	.10	550	Reel	TT	Stock	4219-5651	\$3.82
Black	5/16	7.9	.56	14.2	225	15.5	24.0	2.95	.11	550	Reel	TT	Stock	4219-5652	4.42
Black	3/8	9.5	.62	15.7	225	15.5	24.0	3.35	.13	550	Reel	TT	Stock	4219-5653	5.01
Black	1/2	12.7	.78	19.8	225	15.5	10.0	5.50	.19	550	Reel	TT	Stock	4219-5654	5.71

**RECOMMENDED FOR:** Any fuel injected engine application (1985 and newer) in cars, light trucks, off-road vehicles and small engines where a barrier fuel hose is required. Gasoline, Gasoline/Ethanol (E10, E15, E85), 100% Methanol only (Methanol blends not recommended). Diesel, Diesel/Bio-Diesel blends, 100% Bio-Diesel (SME, RME, and PME Bio-Diesels are acceptable).

**TEMPERATURE:** -40°F to +275°F (-40°C to +135°C) continuous service (including Bio-Diesel).  
-40°F to +302°F (-40°C to +150°C) intermittent service (excluding Bio-Diesel).

**CONSTRUCTION:** **Tube:** Type C (Nitrile). Fuel resistant, synthetic rubber, black, with thermoplastic barrier.  
**Reinforcement:** Spiral textile.  
**Cover:** Type J (CPE). Synthetic rubber.  
**Design Factor:** 5:1

**COUPLINGS:** 75 Gates GLX®, GLP, beaded end with clamp, aluminum crimp ferrules with GC stem, and SAE J2044 quick-connect stems (barb must be suitable for rubber hose). Reference the Hose Coupling Section.

**STANDARDS:** CARB small engine off-road (CARB certificate Q-09-019).  
Exceeds SAE J30R14T2+ (except kink) with SAE J30R12 burst.  
Meets Gates GTS-05-067 high-pressure fuel line specification and Caterpillar CAT 1E4340 (Type A and B) diesel and Bio-Diesel specification.

AGRICULTURE
AIR BREATHING
AIR DUCT
AIR AND MULTI-PURPOSE
CHEMICAL
FOOD AND BEVERAGE
MARINE AND ENGINE
MATERIAL HANDLING
MINING
OILFIELD
PETROLEUM
PRESSURE WASH AND WASHDOWN
STEAM
WATER
CLAMPS
COUPLINGS AND FERRULES
HOSE FINDER
CHEMICAL RESISTANCE TABLE

## Marine and Engine Hose

### MIL Low Pressure Fuel & Oil Hose



Color	Hose I.D.		Hose O.D.		Max. W.P. (psi)	(Bar)	Vac. (In. Hg)	MBR (in)	Wt. Per ft (Lbs.)	Length (ft)	Std. Pack	Pkg Code	Stock or MTO (ft)	Gates Item No.	List Price Per ft
	(in)	(mm)	(in)	(mm)											
Black	1/4	6.4	.59	15.0	250	17.2	—	3.0	.15	10	Ctn	T	MTO	3336-0359	\$9.41
Black	5/16	7.9	.66	16.8	250	17.2	—	3.0	.17	10	Ctn	T	MTO	3336-0364	10.59
Black	3/8	9.5	.72	18.3	250	17.2	—	3.0	.20	10	Ctn	T	MTO	3336-0369	12.02
Black	1/2	12.7	.84	21.3	250	17.2	—	5.0	.24	10	Ctn	T	Stock	3336-0374	13.97
Black	5/8	15.9	.97	24.6	250	17.2	—	6.0	.28	10	Ctn	T	Stock	3336-0379	18.29
Black	3/4	19.1	1.09	27.7	250	17.2	—	6.0	.29	10	Ctn	T	Stock	3336-0384	22.85
Black	7/8	22.2	1.22	31.0	250	17.2	—	7.0	.34	10	Ctn	T	MTO	3336-0389	24.66
Black	1	25.4	1.34	34.0	250	17.2	—	8.0	.38	10	Ctn	T	MTO	3336-0394	28.53
Black	1 1/4	31.8	1.52	38.6	200	13.8	—	10.0	.62	10	Ctn	T	MTO	3336-0399	34.22
Black	1 1/2	38.1	1.77	45.0	200	13.8	—	12.0	.71	10	Ctn	T	MTO	3336-0414	35.42
Black	1 1/2	38.1	1.77	45.0	200	13.8	—	12.0	.71	50	Ctn	T	MTO	3336-1890	23.61
Black	1 3/4	44.5	2.02	51.3	150	10.3	—	16.0	.81	10	Ctn	T	MTO	3336-0419	38.43
Black	2	50.8	2.27	57.7	150	10.3	—	20.0	.78	10	Ctn	T	MTO	3336-0424	41.45
Black	2	50.8	2.27	57.7	150	10.3	—	20.0	.78	50	Ctn	T	MTO	3336-1891	27.63
Black	2 1/4	57.2	2.52	64.0	100	6.9	—	20.0	1.01	10	Ctn	T	MTO	3336-0429	42.60
Black	2 1/2	63.5	2.77	70.4	100	6.9	—	25.0	1.10	10	Ctn	T	MTO	3336-0434	45.93
Black	2 1/2	63.5	2.77	70.4	100	6.9	—	25.0	1.10	50	Ctn	T	MTO	3336-1897	45.93
Black	3	76.2	3.27	83.1	100	6.9	—	36.0	1.28	10	Ctn	T	MTO	3336-0444	49.02
Black	3 1/2	88.9	3.81	96.8	90	6.2	—	42.0	1.82	10	Ctn	T	MTO	3336-0459	57.33
Black	4	101.6	4.30	109.2	75	5.2	—	48.0	1.78	10	Ctn	T	MTO	3336-0457	66.33

**RECOMMENDED FOR:** For use in fuel, oil, coolant, water and alcohol lines requiring MIL-DTL-6000.

**CAUTION:** This product is not intended or designed for use in any manned, rotor, or fixed-wing aircraft, even on an emergency or temporary basis.

**TEMPERATURE:** -40°F to +250°F (-40°C to +121°C). Coolant applications only.

**CONSTRUCTION:** **Tube:** Type A (Chloroprene). Black.  
**Reinforcement:** Braided, high tensile synthetic textile cord.  
**Cover:** Type A (Chloroprene). Black.  
**Design Factor:** 4:1

**COUPLINGS:** 19, 21 or 48. Reference the Hose Coupling Section.

**STANDARDS:** MIL-DTL-6000  
 QPL-6000-16. Test reference MOAMA (MONEB).

AGRICULTURE

AIR BREATHING

AIR DUCT

AIR AND MULTI-PURPOSE

CHEMICAL

FOOD AND BEVERAGE

MARINE AND ENGINE

MATERIAL HANDLING

MINING

OILFIELD

PETROLEUM

PRESSURE WASH AND WASHDOWN

STEAM

WATER

CLAMPS

COUPLINGS AND FERRULES

HOSE FINDER

CHEMICAL RESISTANCE TABLE

## Marine and Engine Hose

### 4175EC Coolant Hose

Formerly - 75W



AGRICULTURE
AIR BREATHING
AIR DUCT
AIR AND MULTI-PURPOSE
CHEMICAL
FOOD AND BEVERAGE
MARINE AND ENGINE
MATERIAL HANDLING
MINING
OILFIELD
PETROLEUM
PRESSURE WASH AND WASHDOWN
STEAM
WATER
CLAMPS
COUPLINGS AND FERRULES
HOSE FINDER
CHEMICAL RESISTANCE TABLE

Color	Hose I.D.	Hose O.D.	Max. W.P.	Vac.	MBR	Wt. Per ft	Length	Std. Pack	Pkg Code	Stock or MTO	Gates Item No.	List Price Per ft			
	(in)	(mm)											(in)	(mm)	(psi)
Black	3/4	19.1	1.14	29.0	80	5.5	8.0	6.0	.37	50	PLT	T	Stock	4175-0855	\$11.43
Black	7/8	22.2	1.26	32.0	75	5.2	7.0	7.0	.39	50	PLT	T	Stock	4175-0856	11.67
Black	1	25.4	1.39	35.3	138	9.5	7.0	8.0	.42	50	PLT	T	Stock	4175-0857	13.32
Black	1 1/8	28.6	1.52	38.6	125	8.6	6.0	8.0	.47	50	PLT	T	Stock	4175-0859	13.92
Black	1 1/4	31.8	1.64	41.7	100	6.9	5.0	12.0	.51	50	PLT	T	Stock	4175-0861	14.63
Black	1 3/8	34.9	1.76	44.7	100	6.9	4.0	12.0	.56	50	PLT	T	MTO	4175-0863	15.57
Black	1 1/2	38.1	1.89	48.0	100	6.9	3.0	12.0	.60	50	PLT	T	Stock	4175-0865	16.07
Black	1 5/8	41.3	2.02	51.3	88	6.1	2.0	15.0	.63	50	PLT	T	Stock	4175-0867	16.59
Black	1 3/4	44.5	2.14	54.4	75	5.2	1.0	15.0	.67	50	PLT	T	Stock	4175-0869	16.91
Black	1 7/8	47.6	2.26	57.4	75	5.2	—	—	.72	50	PLT	T	Stock	4175-0871	17.33
Black	2	50.8	2.39	60.7	62	4.3	—	—	.76	50	PLT	T	Stock	4175-0872	18.30
Black	2 1/8	54.0	2.52	64.0	62	4.3	—	—	.79	50	PLT	T	MTO	4175-0873	19.56
Black	2 1/4	57.2	2.64	67.1	62	4.3	—	—	.84	50	PLT	T	Stock	4175-0874	19.92
Black	2 3/8	60.3	2.76	70.1	62	4.3	—	—	.88	50	PLT	T	Stock	4175-0875	20.16
Black	2 1/2	63.5	2.89	73.4	62	4.3	—	—	.92	50	PLT	T	Stock	4175-0876	21.08
Black	2 5/8	66.7	3.02	76.7	62	4.3	—	—	.96	50	PLT	T	MTO	4175-0877	23.39
Black	2 3/4	69.9	3.14	79.8	62	4.3	—	—	1.00	50	PLT	T	Stock	4175-0878	24.90
Black	2 7/8	73.0	3.26	82.8	56	3.9	—	—	1.05	50	PLT	T	MTO	4175-0879	25.32
Black	3	76.2	3.39	86.1	50	3.4	—	—	1.09	50	PLT	T	Stock	4175-0880	26.19
Black	3 1/2	88.9	3.89	98.8	18	1.2	—	—	1.18	50	PLT	T	Stock	4175-0883	29.28
Black	4	101.6	4.39	111.5	12	.8	—	—	1.34	50	PLT	T	Stock	4175-0886	33.90
Black	4 1/2	114.3	4.89	124.2	12	.8	—	—	1.52	50	PLT	T	Stock	4175-0889	37.80

**RECOMMENDED FOR:** Open-end water discharge applications and coolant connections on marine and stationary engines.

**TEMPERATURE:** -40°F to +257°F (-40°C to +125°C) continuous service.

**CONSTRUCTION:**  
**Tube:** Type P (EPDM). Black.  
**Reinforcement:** Multiple plies of synthetic fabric.  
**Cover:** Type P (EPDM). Black. Heat and ozone resistant.  
**Design Factor:** 4:1

**COUPLINGS:** 1, 5, 6 or 7. Reference the Hose Coupling Section.

**STANDARDS:** Meets SAE 20R1, Class D2.  
**Cover:** ARPM (Class C) Limited oil-resistance.

## Marine and Engine Hose

### 4176HD Coolant Hose

Formerly - 76W



Color	Hose I.D.		Hose O.D.		Max. W.P.		Vac.	MBR	Wt. Per ft	Length	Std. Pack	Pkg Code	Stock or MTO	Gates Item No.	List Price Per ft
	(in)	(mm)	(in)	(mm)	(psi)	(Bar)	(In. Hg)	(in)	(Lbs.)	(ft)			(ft)		
Black	7/8	22.2	1.38	35.1	175	12.1	15.0	7.0	.58	50	PLT	T	Stock	4176-0856	\$15.33
Black	1	25.4	1.51	38.4	175	12.1	10.0	8.0	.62	50	PLT	T	Stock	4176-0857	16.13
Black	1 1/8	28.6	1.63	41.4	175	12.1	10.0	8.0	.68	50	PLT	T	Stock	4176-0859	17.15
Black	1 1/4	31.8	1.76	44.7	125	8.6	10.0	12.0	.70	50	PLT	T	Stock	4176-0861	18.17
Black	1 3/8	34.9	1.88	47.8	110	7.6	10.0	12.0	.76	50	PLT	T	Stock	4176-0863	19.35
Black	1 1/2	38.1	2.01	51.1	112	7.7	10.0	12.0	.81	50	PLT	T	Stock	4176-0865	19.98
Black	1 5/8	41.3	2.13	54.1	106	7.3	7.0	14.0	.87	50	PLT	T	Stock	4176-0867	21.15
Black	1 3/4	44.5	2.26	57.4	100	6.9	5.0	15.0	.93	50	PLT	T	Stock	4176-0869	21.81
Black	1 7/8	47.6	2.38	60.5	94	6.5	4.0	—	.98	50	PLT	T	MTO	4176-0871	23.21
Black	2	50.8	2.51	63.8	88	6.1	3.0	—	1.00	50	PLT	T	Stock	4176-0872	25.11
Black	2 1/4	57.2	2.76	70.1	88	6.1	1.0	—	1.03	50	PLT	T	Stock	4176-0874	28.61
Black	2 3/8	60.3	2.88	73.2	81	5.6	—	—	1.07	50	PLT	T	MTO	4176-0875	31.46
Black	2 1/2	63.5	3.01	76.5	75	5.2	—	—	1.09	50	PLT	T	Stock	4176-0876	34.22
Black	2 5/8	66.7	3.13	79.5	69	4.8	—	—	1.16	50	PLT	T	MTO	4176-0877	35.94
Black	2 3/4	69.9	3.26	82.8	63	4.3	—	—	1.19	50	PLT	T	Stock	4176-0878	37.70
Black	2 7/8	73.0	3.38	85.9	63	4.3	—	—	1.26	50	PLT	T	MTO	4176-0879	38.40
Black	3	76.2	3.51	89.2	63	4.3	—	—	1.30	50	PLT	T	Stock	4176-0880	38.54
Black	3 1/2	88.9	4.01	101.9	50	3.4	—	—	1.50	50	PLT	T	Stock	4176-0883	47.45
Black	4	101.6	4.51	114.6	38	2.6	—	—	1.69	50	PLT	T	Stock	4176-0886	53.33

**RECOMMENDED FOR:** Open-end heavy-duty water discharge applications and coolant connections on marine and stationary engines.

**TEMPERATURE:** -40°F to +257°F (-40°C to +125°C) continuous service.

**CONSTRUCTION:** **Tube:** Type P (EPDM). Black.  
**Reinforcement:** Multiple plies of synthetic fabric.  
**Cover:** Type P (EPDM). Black. Heat and ozone resistant.  
**Design Factor:** 4:1

**COUPLINGS:** 1, 5, 6 or 7. Reference the Hose Coupling Section.

**STANDARDS:** Meets SAE 20R1, Class D2.  
**Cover:** ARPM (Class C) Limited oil-resistance.

AGRICULTURE

AIR BREATHING

AIR DUCT

AIR AND MULTI-PURPOSE

CHEMICAL

FOOD AND BEVERAGE

MARINE AND ENGINE

MATERIAL HANDLING

MINING

OILFIELD

PETROLEUM

PRESSURE WASH AND WASHDOWN

STEAM

WATER

CLAMPS

COUPLINGS AND FERRULES

HOSE FINDER

CHEMICAL RESISTANCE TABLE

## Marine and Engine Hose

### 4169A Coolant Hose



Color	Hose I.D.	Hose O.D.	Max. W.P.	Vac.	MBR	Wt. Per ft	Length	Std. Pack	Pkg Code	Stock or MTO (ft)	Gates Item No.	List Price Per ft			
	(in)	(mm)	(in)	(mm)	(psi)	(Bar)	(In. Hg)						(in)	(Lbs.)	(ft)
Black	3/4	19.1	1.14	29.0	150	10.3	8.0	10.0	.34	3	Ctn	T	Stock	4169-0210	\$15.32
Black	7/8	22.2	1.26	32.0	150	10.3	7.0	11.0	.38	3	Ctn	T	Stock	4169-0220	15.72
Black	1	25.4	1.39	35.3	135	9.3	7.0	12.0	.43	3	Ctn	T	Stock	4169-0224	16.04
Black	1 1/8	28.6	1.55	39.4	135	9.3	6.0	13.0	.48	3	Ctn	T	Stock	4169-0240	16.61
Black	1 1/4	31.8	1.64	41.7	135	9.3	5.0	14.0	.51	3	Ctn	T	Stock	4169-0246	17.58
Black	1 3/8	34.9	1.76	44.7	100	6.9	4.0	25.0	.56	3	Ctn	T	Stock	4169-0260	18.57
Black	1 1/2	38.1	1.89	48.0	100	6.9	3.0	30.0	.60	3	Ctn	T	Stock	4169-0270	19.25
Black	1 5/8	41.3	2.02	51.3	85	5.9	2.0	—	.63	3	Ctn	T	Stock	4169-0280	20.28
Black	1 3/4	44.5	2.14	54.4	75	5.2	1.0	—	.68	3	Ctn	T	Stock	4169-0288	20.96
Black	1 7/8	47.6	2.26	57.4	75	5.2	—	—	.73	3	Ctn	T	Stock	4169-0300	22.29
Black	2	50.8	2.39	60.7	60	4.1	—	—	.77	3	Ctn	T	Stock	4169-0484	22.82
Black	2 1/8	54.0	2.52	64.0	60	4.1	—	—	.88	3	Ctn	T	Stock	4169-0320	24.36
Black	2 1/4	57.2	2.64	67.1	60	4.1	—	—	.93	3	Ctn	T	Stock	4169-0491	25.46
Black	2 3/8	60.3	2.76	70.1	60	4.1	—	—	.97	3	Ctn	T	Stock	4169-0340	26.18
Black	2 1/2	63.5	2.89	73.4	60	4.1	—	—	1.02	3	Ctn	T	Stock	4169-0345	27.93
Black	2 5/8	66.7	3.02	76.7	60	4.1	—	—	1.07	3	Ctn	T	MTO	4169-0360	30.32
Black	2 3/4	69.9	3.14	79.8	60	4.1	—	—	1.12	3	Ctn	T	Stock	4169-0362	32.22
Black	2 7/8	73.0	3.26	82.8	55	3.8	—	—	1.16	3	Ctn	T	MTO	4169-0376	32.90
Black	3	76.2	3.39	86.1	50	3.4	—	—	1.20	3	Ctn	T	Stock	4169-0383	34.04
Black	3 1/4	82.6	3.64	92.5	35	2.4	—	—	1.30	3	Ctn	T	MTO	4169-0402	36.05
Black	3 1/2	88.9	3.89	98.8	10	.7	—	—	1.40	3	Ctn	T	Stock	4169-0420	37.92
Black	4	101.6	4.39	111.5	10	.7	—	—	1.69	3	Ctn	T	Stock	4169-0425	43.97
Black	4 1/2	114.3	4.89	124.2	10	.7	—	—	1.90	3	Ctn	T	MTO	4169-0433	49.25

**RECOMMENDED FOR:** Open-end water discharge applications and coolant connections on marine and stationary engines where oil resistance is required.

**TEMPERATURE:** -40°F to +212°F (-40°C to +100°C) continuous service.

**CONSTRUCTION:**  
**Tube:** Type C (Nitrile). Black. Oil and heat-resistant.  
**Reinforcement:** Two plies of synthetic fabric.  
**Cover:** Type A (Chloroprene). Black.  
**Design Factor:** 4:1

**COUPLINGS:** 1, 5, 6 or 7. Reference the Hose Coupling Section.

**STANDARDS:** Meets requirements of SAE 20R1, Class B Tube, Class C Cover.  
**Tube:** ARPM (Class B) Medium oil-resistance.  
**Cover:** ARPM (Class C) Limited oil-resistance.

## Marine and Engine Hose

### Green Stripe® Coolant and Air Hose



Color	Hose I.D.		Hose O.D.		Max. W.P.		Vac.	MBR	Wt. Per ea	Length	Std. Pack	Pkg Code	Stock or MTO	Gates Item No.	List Price Per ea
	(in)	(mm)	(in)	(mm)	(psi)	(Bar)	(In. Hg)	(in)	(Lbs.)	(ea)			(ea)		
Black	1	25.4	1.46	37.1	100	6.9	25.0	2.0	2.50	5	Ctn	T	Stock	4685-2016	\$158.49
Black	1 1/8	28.6	1.58	40.1	100	6.9	25.0	2.5	5.30	5	Ctn	T	Stock	4685-2018	166.83
Black	1 1/4	31.8	1.71	43.4	100	6.9	25.0	2.5	3.13	5	Ctn	T	Stock	4685-2020	180.36
Black	1 3/8	34.9	1.83	46.5	85	5.9	25.0	3.0	3.25	5	Ctn	T	Stock	4685-2022	182.87
Black	1 1/2	38.1	1.96	49.8	85	5.9	20.0	3.5	3.62	5	Ctn	T	Stock	4685-2024	185.54
Black	1 5/8	41.3	2.08	52.8	75	5.2	20.0	3.5	3.88	5	Ctn	T	Stock	4685-2026	206.25
Black	1 3/4	44.5	2.21	56.1	75	5.2	20.0	4.0	5.07	5	Ctn	T	Stock	4685-2028	221.12
Black	1 7/8	47.6	2.33	59.2	60	4.1	20.0	4.5	5.24	5	Ctn	T	Stock	4685-2030	225.80
Black	2	50.8	2.46	62.5	60	4.1	20.0	4.5	5.07	5	Ctn	T	Stock	4685-2032	233.46
Black	2 1/8	54.0	2.58	65.5	55	3.8	20.0	5.5	5.35	5	Ctn	T	Stock	4685-2034	239.15
Black	2 1/4	57.2	2.71	68.8	55	3.8	20.0	5.5	5.62	5	Ctn	T	Stock	4685-2036	244.67
Black	2 3/8	60.3	2.83	71.9	50	3.4	20.0	6.5	5.91	5	Ctn	T	Stock	4685-2038	256.52
Black	2 1/2	63.5	2.96	75.2	50	3.4	20.0	6.5	6.15	5	Ctn	T	Stock	4685-2040	270.05
Black	2 5/8	66.7	3.08	78.2	40	2.8	15.0	7.5	6.45	5	Ctn	T	Stock	4685-2042	273.72
Black	2 3/4	69.9	3.21	81.5	40	2.8	15.0	7.5	6.30	5	Ctn	T	Stock	4685-2044	290.42
Black	2 7/8	73.0	3.33	84.6	40	2.8	15.0	9.0	7.01	5	Ctn	T	Stock	4685-2046	297.27
Black	3	76.2	3.43	87.1	40	2.8	15.0	9.0	6.56	5	Ctn	T	Stock	4685-2048	307.79
Black	3 1/2	88.9	3.93	99.8	35	2.4	15.0	12.0	7.56	5	Ctn	T	Stock	4685-2056	343.70
Black	4	101.6	4.43	112.5	30	2.1	10.0	20.0	8.57	5	Ctn	T	Stock	4685-2064	374.25
Black	5	127.0	5.43	137.9	15	1.0	5.0	24.0	13.45	5	Ctn	T	MTO	4685-2080	494.00
Black	6	152.4	6.43	163.3	15	1.0	5.0	30.0	15.00	5	Ctn	T	Stock	4685-2096	558.14

**RECOMMENDED FOR:** Open-end water discharge applications and coolant on marine and stationary engines where tight bends or suction capabilities are required.

**CAUTION:** Do not use for fuel or oil transfer applications.

**TEMPERATURE:** -40°F to +257°F (-40°C to +125°C) continuous service.

**CONSTRUCTION:** **Tube:** Type P (EPDM). Black.  
**Reinforcement:** Multiple plies of synthetic fabric and two built-in helical steel wires.  
**Cover:** Type P (EPDM). Black with green stripe.  
**Design Factor:** 4:1

**COUPLINGS:** 1, 5, 6 or 7. Reference the Hose Coupling Section.

**STANDARDS:** Meets requirements of SAE 20R2 (20R5 Burst).  
**Tube:** Meets D1 and D2. Meets D3 except for air aging standard.  
**Cover:** Meets D1 and D2.

AGRICULTURE

AIR BREATHING

AIR DUCT

AIR AND MULTI-PURPOSE

CHEMICAL

FOOD AND BEVERAGE

MARINE AND ENGINE

MATERIAL HANDLING

MINING

OILFIELD

PETROLEUM

PRESSURE WASH AND WASHDOWN

STEAM

WATER

CLAMPS

COUPLINGS AND FERRULES

HOSE FINDER

CHEMICAL RESISTANCE TABLE

## Engine Coolant Silicone



AGRICULTURE
AIR BREATHING
AIR DUCT
AIR AND MULTI-PURPOSE
CHEMICAL
FOOD AND BEVERAGE
MARINE AND ENGINE
MATERIAL HANDLING
MINING
OILFIELD
PETROLEUM
PRESSURE WASH AND WASHDOWN
STEAM
WATER
CLAMPS
COUPLINGS AND FERRULES
HOSE FINDER
CHEMICAL RESISTANCE TABLE

Color	Hose I.D.	Hose O.D.	Max. W.P.	Vac.	MBR	Wt. Per ft	Length	Std. Pack	Pkg Code	Stock or MTO	Gates Item No.	List Price Per ft			
	(in)												(mm)	(psi)	(Bar)
Green	3/8	9.5	.76	19.3	110	7.6	12.0	8.0	.19	10	Ctn	T	Stock	4171-0195	\$31.61
Green	1/2	12.7	.87	22.1	110	7.6	12.0	8.0	.23	10	Ctn	T	Stock	4171-0197	36.05
Green	5/8	15.9	1.02	25.9	110	7.6	12.0	8.0	.27	10	Ctn	T	Stock	4171-0204	38.64
Green	3/4	19.1	1.14	29.0	110	7.6	10.0	10.0	.31	10	Ctn	T	Stock	4171-0206	42.68
Green	7/8	22.2	1.26	32.0	110	7.6	7.0	11.0	.35	10	Ctn	T	Stock	4171-0210	45.68
Green	1	25.4	1.39	35.3	90	6.2	7.0	12.0	.40	10	Ctn	T	Stock	4171-0213	48.21
Green	1 1/8	28.6	1.52	38.6	90	6.2	6.0	13.0	.44	10	Ctn	T	Stock	4171-0217	50.90
Green	1 1/4	31.8	1.64	41.7	85	5.9	5.0	14.0	.48	10	Ctn	T	Stock	4171-0265	53.90
Green	1 3/8	34.9	1.76	44.7	85	5.9	4.0	26.0	.52	10	Ctn	T	Stock	4171-0260	56.75
Green	1 1/2	38.1	1.89	48.0	85	5.9	3.0	30.0	.57	10	Ctn	T	Stock	4171-0270	59.54
Green	1 5/8	41.3	2.02	51.3	80	5.5	2.0	—	.61	10	Ctn	T	Stock	4171-0275	62.54
Green	1 3/4	44.5	2.14	54.4	80	5.5	1.0	—	.65	10	Ctn	T	Stock	4171-0280	65.58
Green	2	50.8	2.39	60.7	75	5.2	—	—	.73	10	Ctn	T	Stock	4171-0285	71.07
Green	2 1/8	54.0	2.52	64.0	75	5.2	—	—	.77	10	Ctn	T	Stock	4171-0224	75.05
Green	2 1/4	57.2	2.64	67.1	75	5.2	—	—	.81	10	Ctn	T	Stock	4171-0223	78.99
Green	2 3/8	60.3	2.76	70.1	65	4.5	—	—	.91	10	Ctn	T	Stock	4171-0229	80.96
Green	2 1/2	63.5	2.89	73.4	65	4.5	—	—	.96	10	Ctn	T	Stock	4171-0234	83.96
Green	2 3/4	69.9	3.14	79.8	50	3.4	—	—	1.04	10	Ctn	T	Stock	4171-0238	90.21
Green	3	76.2	3.39	86.1	50	3.4	—	—	1.17	10	Ctn	T	Stock	4171-0246	100.71
Green	3 1/4	82.6	3.64	92.5	40	2.8	—	—	1.27	10	Ctn	T	Stock	4171-0249	111.36
Green	3 1/2	88.9	3.89	98.8	35	2.4	—	—	1.36	10	Ctn	T	Stock	4171-0241	120.11
Green	3 3/4	95.3	4.14	105.2	35	2.4	—	—	1.44	10	Ctn	T	MTO	4171-0835	126.11
Green	4	101.6	4.39	111.5	35	2.4	—	—	1.54	10	Ctn	T	Stock	4171-0290	133.92
Green	4 1/2	114.3	4.89	124.2	25	1.7	—	—	1.73	10	Ctn	T	MTO	4171-0295	149.96

**RECOMMENDED FOR:** Open-end water discharge and coolant connections on marine and stationary engines where extremely high and low temperature resistance is required.

**TEMPERATURE:** -65°F to +347°F (-54°C to +175°C) continuous service.

**CONSTRUCTION:** **Tube:** Type MQ (Silicone). Orange.  
**Reinforcement:** Multiple plies of synthetic fabric.  
**Cover:** Type MQ (Silicone). Green.  
**Design Factor:** 4:1

**COUPLINGS:** 1, 5, 6 or 7. Reference the Hose Coupling Section.

**STANDARDS:** Meets requirements of SAE 20R1, Class A standard wall.

## Marine and Engine Hose

### 4230T Coolant Hose



Color	Hose I.D.		Hose O.D.		Max. W.P.		Vac.	MBR	Wt. Per ft	Length	Std. Pack	Pkg Code	Stock or MTO (ft)	Gates Item No.	List Price Per ft
	(in)	(mm)	(in)	(mm)	(psi)	(Bar)	(In. Hg)	(in)	(Lbs.)	(ft)					
Black	5/16	7.9	.62	15.7	75	5.2	25.0	2.0	.15	700	Ctn	FF	Stock	4230-0193	\$1.58
Black	3/8	9.5	.69	17.5	75	5.2	25.0	2.5	.17	500	Ctn	YY	Stock	4230-0129	1.62
Black	1/2	12.7	.81	20.6	75	5.2	25.0	3.0	.23	700	Ctn	FF	Stock	4230-0060	1.82
Black	5/8	15.9	.94	23.9	75	5.2	25.0	4.0	.25	300	Ctn	FF	Stock	4230-0135	2.06
Black	3/4	19.1	1.06	26.9	75	5.2	25.0	5.0	.29	200	Ctn	YY	Stock	4230-0134	2.51
Black	1	25.4	1.34	34.0	75	5.2	25.0	7.0	.40	600	Ctn	YY	Stock	4230-0150	3.38

**RECOMMENDED FOR:** Standard heater lines and small diameter coolant connections.

**TEMPERATURE:** -40°F to +257°F (-40°C to +125°C) continuous service.

**CONSTRUCTION:** **Tube:** Type P (EPDM). Black.  
**Reinforcement:** Synthetic, high tensile textile cord.  
**Cover:** Type P (EPDM). Black.  
**Design Factor:** 4:1

**COUPLINGS:** 1, 5, 6 or 7. Reference the Hose Coupling Section.

**STANDARDS:** Meets requirements of SAE 20R3 Class D2 (except durometer and compression set).

AGRICULTURE

AIR BREATHING

AIR DUCT

AIR AND MULTI-PURPOSE

CHEMICAL

FOOD AND BEVERAGE

MARINE AND ENGINE

MATERIAL HANDLING

MINING

OILFIELD

PETROLEUM

PRESSURE WASH AND WASHDOWN

STEAM

WATER

CLAMPS

COUPLINGS AND FERRULES

HOSE FINDER

CHEMICAL RESISTANCE TABLE



## Marine and Engine Hose

### Marine Master™ Wet Exhaust 100D



AGRICULTURE
AIR BREATHING
AIR DUCT
AIR AND MULTI-PURPOSE
CHEMICAL
FOOD AND BEVERAGE
MARINE AND ENGINE
MATERIAL HANDLING
MINING
OILFIELD
PETROLEUM
PRESSURE WASH AND WASHDOWN
STEAM
WATER
CLAMPS
COUPLINGS AND FERRULES
HOSE FINDER
CHEMICAL RESISTANCE TABLE

Color	Hose I.D.	$\ominus$	Hose O.D.	$\odot$	Max. W.P.	$\text{Ⓢ}$	Vac.	MBR	Wt. Per ea	Length	Std. Pack	Pkg Code	Stock or MTO (ea)	Gates Item No.	List Price Per ea
	(in)	(mm)	(in)	(mm)	(psi)	(Bar)	(In. Hg)	(in)	(Lbs.)	(ea)					
Black	1 1/8	28.6	1.40	35.6	100	6.9	—	—	5.59	12.5	PLT	T	MTO	3137-1207	\$217.50
Black	1 1/4	31.8	1.53	38.9	100	6.9	—	—	6.07	12.5	PLT	T	MTO	3137-1209	228.38
Black	1 3/8	34.9	1.69	42.9	100	6.9	—	—	6.58	12.5	PLT	T	MTO	3137-1213	243.38
Black	1 1/2	38.1	1.78	45.2	100	6.9	—	—	7.12	12.5	PLT	T	Stock	3137-1215	251.07
Black	1 5/8	41.3	1.91	48.5	100	6.9	—	—	7.63	12.5	PLT	T	MTO	3137-1217	259.32
Black	1 3/4	44.5	2.03	51.6	100	6.9	—	—	8.15	12.5	PLT	T	MTO	3137-1219	264.20
Black	1 7/8	47.6	2.19	55.9	100	6.9	—	—	8.63	12.5	PLT	T	MTO	3137-1221	270.75
Black	2	50.8	2.32	58.9	100	6.9	—	—	9.18	12.5	PLT	T	Stock	3137-1223	285.95
Black	2 1/8	54.0	2.45	62.2	100	6.9	—	—	9.69	12.5	PLT	T	Stock	3137-1225	305.63
Black	2 1/4	57.2	2.57	65.3	100	6.9	—	—	10.00	12.5	PLT	T	MTO	3137-1227	311.25
Black	2 3/8	60.3	2.69	68.3	100	6.9	—	—	10.70	12.5	PLT	T	MTO	3137-1229	315.00
Black	2 1/2	63.5	2.82	71.6	100	6.9	—	—	11.24	12.5	PLT	T	Stock	3137-1231	329.25
Black	2 5/8	66.7	2.95	74.9	100	6.9	—	—	11.79	12.5	PLT	T	MTO	3137-1233	365.45
Black	2 3/4	69.9	3.09	78.5	100	6.9	—	—	12.29	12.5	PLT	T	MTO	3137-1235	389.07
Black	2 7/8	73.0	3.23	82.0	100	6.9	—	—	12.80	12.5	PLT	T	Stock	3137-1237	395.63
Black	3	76.2	3.36	85.3	100	6.9	—	—	14.45	12.5	PLT	T	Stock	3137-1239	409.32
Black	3 1/2	88.9	3.86	98.0	100	6.9	—	—	16.63	12.5	PLT	T	MTO	3137-1245	457.50
Black	4	101.6	4.36	110.7	100	6.9	—	—	18.57	12.5	PLT	T	Stock	3137-1249	529.70
Black	4 1/2	114.3	4.86	123.4	100	6.9	—	—	21.00	12.5	PLT	T	Stock	3137-1252	590.63
Black	5	127.0	5.37	136.4	100	6.9	—	—	23.35	12.5	PLT	T	MTO	3137-1253	699.95
Black	6	152.4	6.38	162.1	100	6.9	—	—	27.14	12.5	PLT	T	MTO	3137-1254	909.95

**RECOMMENDED FOR:** Heavy-duty fabric reinforced. Designed for use where wire support is not required. Meets marine water and wet exhaust hose requirements. May be used for engine water circulation, discharge lines, heat exchangers and straight wet exhaust connections.

**TEMPERATURE:** -40°F to +257°F (-40°C to +125°C) continuous service.

**CONSTRUCTION:**  
**Tube:** Type P (EPDM). Black.  
**Reinforcement:** Two plies of synthetic fabric.  
**Cover:** Type P (EPDM). Black with blue stripe.  
**Design Factor:** 4:1

**STANDARDS:** Meets requirements of SAE J2006 R1.

## Marine and Engine Hose

### Marine Master™ Wet Exhaust 100SD



Color	Hose I.D.		Hose O.D.		Max. W.P.		Vac.	MBR	Wt. Per ea	Length	Std. Pack	Pkg Code	Stock or MTO	Gates Item No.	List Price Per ea
	(in)	(mm)	(in)	(mm)	(psi)	(Bar)	(In. Hg)	(in)	(Lbs.)	(ea)			(ea)		
Black	1 1/8	28.6	1.50	38.1	100	6.9	25.0	2.5	7.31	12.5	PLT	T	MTO	4686-0602	\$326.25
Black	1 1/4	31.8	1.63	41.4	100	6.9	25.0	2.5	7.92	12.5	PLT	T	MTO	4686-0604	342.57
Black	1 3/8	34.9	1.75	44.5	100	6.9	25.0	3.0	8.55	12.5	PLT	T	MTO	4686-0606	365.07
Black	1 1/2	38.1	1.88	47.8	100	6.9	20.0	3.5	9.19	12.5	PLT	T	MTO	4686-0608	376.70
Black	1 5/8	41.3	2.00	50.8	100	6.9	20.0	3.5	9.69	12.5	PLT	T	MTO	4686-0610	389.07
Black	1 3/4	44.5	2.12	53.8	100	6.9	20.0	4.0	10.46	12.5	PLT	T	MTO	4686-0612	396.38
Black	1 7/8	47.6	2.24	56.9	100	6.9	20.0	4.5	11.09	12.5	PLT	T	MTO	4686-0614	406.13
Black	2	50.8	2.36	59.9	100	6.9	20.0	5.0	11.90	12.5	PLT	T	MTO	4686-0616	429.00
Black	2 1/8	54.0	2.49	63.2	100	6.9	20.0	5.5	12.98	12.5	PLT	T	MTO	4686-0618	458.45
Black	2 1/4	57.2	2.63	66.8	100	6.9	20.0	6.0	13.04	12.5	PLT	T	MTO	4686-0620	466.88
Black	2 3/8	60.3	2.75	69.9	100	6.9	20.0	6.5	14.45	12.5	PLT	T	Stock	4686-0622	472.50
Black	2 1/2	63.5	2.90	73.7	100	6.9	20.0	6.5	15.14	12.5	PLT	T	MTO	4686-0624	493.88
Black	2 5/8	66.7	3.02	76.7	100	6.9	15.0	7.0	15.80	12.5	PLT	T	Stock	4686-0626	548.25
Black	2 3/4	69.9	3.22	81.8	100	6.9	15.0	7.5	16.48	12.5	PLT	T	MTO	4686-0628	583.70
Black	2 7/8	73.0	3.42	86.9	100	6.9	15.0	8.0	21.06	12.5	PLT	T	MTO	4686-0630	593.45
Black	3	76.2	3.54	89.9	100	6.9	15.0	9.0	19.34	12.5	PLT	T	Stock	4686-0632	614.07
Black	3	76.2	3.54	89.9	100	6.9	15.0	9.0	1.55	200	PLT	T	MTO	4686-0656	49.13
Black	3 1/2	88.9	4.04	102.6	100	6.9	15.0	9.0	22.23	12.5	PLT	T	MTO	4686-0638	686.25
Black	3 1/2	88.9	4.04	102.6	100	6.9	15.0	9.0	1.78	200	PLT	T	MTO	4686-0657	54.90
Black	4	101.6	4.54	115.3	100	6.9	10.0	12.0	27.54	12.5	PLT	T	MTO	4686-0640	794.63
Black	4 1/2	114.3	5.04	128.0	100	6.9	10.0	12.0	30.79	12.5	PLT	T	Stock	4686-0642	885.95
Black	5	127.0	5.54	140.7	100	6.9	5.0	20.0	33.93	12.5	PLT	T	Stock	4686-0643	1,050.00
Black	5 1/2	139.7	6.04	153.4	100	6.9	5.0	22.0	39.14	12.5	PLT	T	MTO	4686-0645	1,203.75
Black	6	152.4	6.68	169.7	100	6.9	5.0	24.0	40.22	12.5	PLT	T	MTO	4686-0646	1,365.00

NOTE: 4686-0656 and 4686-0657 are priced per foot.

**RECOMMENDED FOR:** Heavy-duty fabric-reinforced hose with a helical steel wire reinforcement to meet marine water and wet exhaust hose requirements. May be used for engine water circulation, discharge lines, heat exchangers and wet exhaust connections.

**TEMPERATURE:** -40°F to +257°F (-40°C to +125°C) continuous service.

**CONSTRUCTION:** **Tube:** Type P (EPDM). Black.  
**Reinforcement:** Two plies of synthetic fabric and two built-in helical steel wires.  
**Cover:** Type P (EPDM). Black corrugated with blue stripe.  
**Design Factor:** 2:1

**STANDARDS:** Meets requirements of SAE J2006 R2.

AGRICULTURE

AIR BREATHING

AIR DUCT

AIR AND MULTI-PURPOSE

CHEMICAL

FOOD AND BEVERAGE

MARINE AND ENGINE

MATERIAL HANDLING

MINING

OILFIELD

PETROLEUM

PRESSURE WASH AND WASHDOWN

STEAM

WATER

CLAMPS

COUPLINGS AND FERRULES

HOSE FINDER

CHEMICAL RESISTANCE TABLE

## Marine and Engine Hose

### Marine Master™ Plus Wet Exhaust (15-100) SD

Formerly - 4684CF (Wet Exhaust)



Color	Hose I.D.	Hose O.D.	Max. W.P.	Vac.	MBR	Wt. Per ft	Length	Std. Pack	Pkg Code	Stock or MTO (ft)	Gates Item No.	List Price Per ft
	(in)	(mm)	(psi)	(in. Hg)	(in)	(Lbs.)	(ft)					
Black	1	25.4	100	25.0	3.0	.51	10	STRT	T	Stock	4684-1540	\$19.80
Black	1 1/8	28.6	100	25.0	4.0	.56	10	STRT	T	Stock	4684-1545	21.44
Black	1 1/4	31.8	100	25.0	4.0	.61	10	STRT	T	Stock	4684-1551	22.61
Black	1 3/8	34.9	85	25.0	4.0	.66	10	STRT	T	Stock	4684-1556	23.25
Black	1 1/2	38.1	85	20.0	4.0	.70	10	STRT	T	Stock	4684-1561	23.72
Black	1 5/8	41.3	75	20.0	5.0	.75	10	STRT	T	Stock	4684-1601	24.02
Black	1 3/4	44.5	75	20.0	5.0	.80	10	STRT	T	Stock	4684-1611	25.41
Black	1 7/8	47.6	60	20.0	5.0	.85	10	STRT	T	Stock	4684-1651	26.90
Black	2	50.8	62	20.0	5.0	.90	10	Ctn	T	Stock	4684-1660	28.07
Black	2 1/8	54.0	55	20.0	6.0	.95	10	Ctn	T	Stock	4684-1670	29.10
Black	2 1/4	57.2	55	20.0	6.0	1.00	10	Ctn	T	Stock	4684-1680	30.60
Black	2 3/8	60.3	50	20.0	7.0	1.06	10	Ctn	T	Stock	4684-1690	32.91
Black	2 1/2	63.5	50	20.0	7.0	1.11	10	Ctn	T	Stock	4684-1700	33.84
Black	2 5/8	66.7	40	15.0	9.0	1.16	10	Ctn	T	Stock	4684-1711	34.29
Black	2 3/4	69.9	40	15.0	10.0	1.21	10	Ctn	T	Stock	4684-1720	34.58
Black	2 7/8	73.0	40	15.0	11.0	1.26	10	Ctn	T	Stock	4684-1730	35.75
Black	3	76.2	44	15.0	12.0	1.32	10	Ctn	T	Stock	4684-1740	36.57
Black	3	76.2	44	15.0	12.0	1.54	200	PLT	T	MTO	4684-1706	36.57
Black	3 1/2	88.9	35	15.0	17.0	1.50	10	PLT	T	Stock	4684-1750	41.45
Black	3 1/2	88.9	35	15.0	17.0	1.37	200	PLT	T	MTO	4684-1707	41.45
Black	4	101.6	30	10.0	24.0	1.65	10	PLT	T	Stock	4684-1760	43.74
Black	4 1/2	114.3	25	5.0	27.0	1.85	10	PLT	T	MTO	4684-1764	47.63
Black	4 1/2	114.3	25	5.0	27.0	1.76	200	PLT	T	MTO	4684-1708	47.63
Black	5	127.0	20	5.0	30.0	2.02	10	PLT	T	MTO	4684-1766	51.51
Black	5	127.0	20	5.0	30.0	2.21	200	PLT	T	MTO	4684-1709	51.51
Black	6	152.4	15	5.0	36.0	2.40	10	PLT	T	MTO	4684-1722	59.27

**RECOMMENDED FOR:** Marine wet exhaust and general purpose applications. Suitable for coolant lines where tight bends are required.

**TEMPERATURE:** -40°F to +212°F (-40°C to +100°C) continuous service.

**CONSTRUCTION:**  
**Tube:** Type C (Nitrile). Black. Oil and heat-resistant.  
**Reinforcement:** Synthetic fabric with built-in wire.  
**Cover:** Type A (Chloroprene). Black corrugated with red stripe. Oil and heat-resistant.  
**Design Factor:** 4:1

**STANDARDS:** Meets requirements of SAE 20R2, SAE 20R5, SAE J2006.

**Tube:** ARPM (Class B) Medium oil-resistance.  
**Cover:** ARPM (Class C) Limited oil-resistance.

## Marine and Engine Hose

### C5M Marine Fuel Line Hose



Color	Hose I.D.		Hose O.D.		Max. W.P.		Vac.	MBR	Wt. Per ft	Length	Std. Pack	Pkg Code	Stock or MTO	Gates Item No.	List Price Per ft
	(in)	(mm)	(in)	(mm)	(psi)	(Bar)									
Blue	1/4	6.4	.58	14.7	500	34.5	24.0	1.3	.21	385	Reel	E	Stock	3658-1965	\$**
Blue	5/16	7.9	.67	17.0	500	34.5	24.0	1.3	.27	385	Reel	E	Stock	3658-1969	**
Blue	13/32	10.3	.77	19.6	500	34.5	24.0	1.8	.33	330	Reel	F	Stock	3658-1973	**
Blue	1/2	12.7	.92	23.4	500	34.5	10.0	2.3	.40	275	Reel	F	Stock	3658-1977	**
Blue	5/8	15.9	1.08	27.4	500	34.5	10.0	2.8	.51	220	Reel	F	Stock	3658-1981	**
Blue	7/8	22.2	1.23	31.2	500	34.5	10.0	3.5	.62	165	Reel	F	Stock	3658-1985	**

NOTE: \*\* Refer to Hydraulic Price Sheet (35096-00) for Prices or call Customer Service 1-800-366-3128.

**RECOMMENDED FOR:** All commercial and recreational vessel fuel line applications. Suitable for marine diesel, gasoline, B100 Bio-Diesel, gasohol fuels and hot oil applications.

**TEMPERATURE:** -4°F to +212°F (-20°C to +100°C) continuous service.

**CONSTRUCTION:**  
**Tube:** Type C (Nitrile). Black. Oil and heat-resistant.  
**Reinforcement:** Braided, high tensile steel wire.  
**Cover:** Type C2 (Modified Nitrile). Blue.  
**Design Factor:** 4:1

**COUPLINGS:** Brass or Carbon Steel C5 Field Attachable couplings reference Gates Hydraulic catalog #35093.

**STANDARDS:** Meets requirements of SAE J1942 and SAE J1527, USCG Type A, Class 1, Style R3, SAE J30R2, MSHA, ABS and ISO 7840-A1.

**Tube:** ARPM (Class A) High oil-resistance.  
**Cover:** ARPM (Class C) Limited oil-resistance.

AGRICULTURE

AIR BREATHING

AIR DUCT

AIR AND MULTI-PURPOSE

CHEMICAL

FOOD AND BEVERAGE

MARINE AND ENGINE

MATERIAL HANDLING

MINING

OILFIELD

PETROLEUM

PRESSURE WASH AND WASHDOWN

STEAM

WATER

CLAMPS

COUPLINGS AND FERRULES

HOSE FINDER

CHEMICAL RESISTANCE TABLE

## Marine and Engine Hose

### 4219M Marine Master™ Fuel Line 40



AGRICULTURE
AIR BREATHING
AIR DUCT
AIR AND MULTI-PURPOSE
CHEMICAL
FOOD AND BEVERAGE
MARINE AND ENGINE
MATERIAL HANDLING
MINING
OILFIELD
PETROLEUM
PRESSURE WASH AND WASHDOWN
STEAM
WATER
CLAMPS
COUPLINGS AND FERRULES
HOSE FINDER
CHEMICAL RESISTANCE TABLE

Color	Hose I.D.		Hose O.D.		Max. W.P.		Vac.	MBR	Wt. Per ea	Length	Std. Pack	Pkg Code	Stock or MTO (ea)	Gates Item No.	List Price Per ea
	(in)	(mm)	(in)	(mm)	(psi)	(Bar)									
Black	1/4	6.4	.64	16.3	40	2.8	28.0	2.5	4.73	25	Ctn	T	Stock	4219-4145	\$154.76
Black	1/4	6.4	.64	16.3	40	2.8	28.0	2.5	9.46	50	Ctn	T	Stock	4219-4146	309.51
Black	1/4	6.4	.64	16.3	40	2.8	28.0	2.5	45.36	250	Reel	WW	Stock	4219-4140	1,406.85
Black	5/16	7.9	.70	17.8	40	2.8	28.0	3.0	5.08	25	Ctn	T	Stock	4219-4565	180.53
Black	5/16	7.9	.70	17.8	40	2.8	28.0	3.0	53.57	250	Reel	WW	MTO	4219-4560	1,641.12
Black	3/8	9.5	.77	19.6	40	2.8	28.0	3.0	6.10	25	Ctn	T	Stock	4219-4385	210.02
Black	3/8	9.5	.77	19.6	40	2.8	28.0	3.0	11.04	50	Ctn	T	Stock	4219-4567	420.03
Black	3/8	9.5	.77	19.6	40	2.8	28.0	3.0	60.99	250	Reel	WW	Stock	4219-4380	1,909.20
Black	1/2	12.7	.89	22.6	40	2.8	28.0	5.0	7.37	25	Ctn	T	Stock	4219-4125	236.76
Black	1/2	12.7	.89	22.6	40	2.8	28.0	5.0	73.66	250	Reel	WW	Stock	4219-4120	2,152.32
Black	5/8	15.9	1.01	25.7	40	2.8	28.0	6.0	8.61	25	Ctn	T	Stock	4219-4585	282.12
Black	5/8	15.9	1.01	25.7	40	2.8	28.0	6.0	86.10	250	Reel	WW	Stock	4219-4580	2,564.75

**RECOMMENDED FOR:** Flexible connections between rigid fuel distribution lines and engine. Excellent for vent lines and emission control systems. Suitable for marine diesel and gasohol blends of ethanol, methanol and ethers up to 10%.

**TEMPERATURE:** -40°F to +212°F (-40°C to +100°C) continuous service.

**CONSTRUCTION:**  
**Tube:** Type C (Nitrile). Black. Oil and heat-resistant.  
**Reinforcement:** Braided, high tensile synthetic cord.  
**Cover:** Type A (Chloroprene). Black.  
**Design Factor:** 5:1

**STANDARDS:** Meets requirements of SAE J1527, USCG Type A1, Class 1, Style R1.  
**Tube:** ARPM (Class A) High oil-resistance.

## Marine and Engine Hose

### 4219G Fuel Line (35-50)



Color	Hose I.D.		Hose O.D.		Max. W.P.		Vac.	MBR	Wt. Per ft	Length	Std. Pack	Pkg Code	Stock or MTO	Gates Item No.	List Price Per ft
	(in)	(mm)	(in)	(mm)	(psi)	(Bar)									
Black	5/32	4.0	.36	9.1	50	3.4	24.0	2.0	.05	550	Reel	DD	Stock	4219-0104	\$1.56
Black	3/16	4.8	.41	10.4	50	3.4	24.0	3.0	.07	550	Reel	DD	Stock	4219-0093	1.62
Black	1/4	6.4	.50	12.7	50	3.4	24.0	3.0	.10	550	Reel	DD	Stock	4219-0103	1.82
Black	5/16	7.9	.56	14.2	50	3.4	24.0	3.0	.12	550	Reel	DD	Stock	4219-0107	1.97
Black	3/8	9.5	.62	15.7	50	3.4	24.0	4.0	.15	550	Reel	DD	Stock	4219-0109	2.09
Black	1/2	12.7	.78	19.8	35	2.4	10.0	5.0	.18	550	Reel	DD	Stock	4219-0102	2.85
Black	5/8	15.9	.94	23.9	35	2.4	10.0	6.0	.25	550	Reel	DD	Stock	4219-0097	3.90
Black	3/4	19.1	1.13	28.7	35	2.4	10.0	7.0	.36	200	Ctn	YY	Stock	4219-0116	5.79

**RECOMMENDED FOR:** Fuel line applications to provide flexible connections between rigid fuel distribution lines and the engine. Also for use in evaporative emission control systems and as a vent line.

**CAUTION:** Not recommended for fuel injection systems.

**TEMPERATURE:** -40°F to +257°F (-40°C to +125°C) continuous service.

**CONSTRUCTION:** **Tube:** Type C (Nitrile). Black. Oil, gasoline and ethanol resistant.  
**Reinforcement:** Synthetic, high tensile textile.  
**Cover:** Type C2 (Modified Nitrile). Black. Fuel, oil, ozone and high temperature resistant.  
**Design Factor:** 4:1

**STANDARDS:** Exceeds requirements of SAE 30R6 and SAE 30R7.  
**Tube:** ARPM (Class A) High oil-resistance.

AGRICULTURE

AIR BREATHING

AIR DUCT

AIR AND MULTI-PURPOSE

CHEMICAL

FOOD AND BEVERAGE

MARINE AND ENGINE

MATERIAL HANDLING

MINING

OILFIELD

PETROLEUM

PRESSURE WASH AND WASHDOWN

STEAM

WATER

CLAMPS

COUPLINGS AND FERRULES

HOSE FINDER

CHEMICAL RESISTANCE TABLE

## Marine and Engine Hose

### 4663K Fuel Fill Hose - Corrugated



Color	Hose I.D.	Hose O.D.	Max. W.P.	Vac.	MBR	Wt. Per ft	Length	Std. Pack	Pkg Code	Stock or MTO	Gates Item No.	List Price Per ft			
	(in)	(mm)	(in)	(mm)	(psi)	(Bar)	(In. Hg)	(in)	(Lbs.)	(ft)	(ft)				
Black	1 3/8	34.9	1.63	41.4	20	1.4	30.0	5.0	.38	10	Ctn	T	Stock	4663-2828	\$23.87
Black	1 1/2	38.1	1.77	45.0	20	1.4	30.0	5.0	.41	10	Ctn	T	Stock	4663-2830	24.68
Black	1 5/8	41.3	1.90	48.3	20	1.4	30.0	5.5	.44	10	Ctn	T	MTO	4663-3624	25.25
Black	1 3/4	44.5	2.02	51.3	20	1.4	30.0	6.0	.47	10	Ctn	T	MTO	4663-3976	26.18
Black	1 7/8	47.6	2.14	54.4	20	1.4	30.0	6.0	.50	10	Ctn	T	MTO	4663-2933	26.85
Black	2	50.8	2.25	57.2	20	1.4	30.0	7.0	.53	10	Ctn	T	Stock	4663-2930	27.78
Black	2 1/4	57.2	2.50	63.5	20	1.4	30.0	8.0	.59	10	Ctn	T	Stock	4663-2932	30.03
Black	2 1/2	63.5	2.75	69.9	20	1.4	30.0	12.0	.65	10	Ctn	T	MTO	4663-2929	31.64
Black	3	76.2	3.27	83.1	20	1.4	30.0	—	.84	10	Ctn	T	MTO	4663-3625	35.63

**RECOMMENDED FOR:** Fuel tank filler applications to provide a flexible connector between fuel tank and fill pipe. Suitable for fill applications on automobiles, trucks, buses and other similar applications where exceptionally flexible hose is required.

**TEMPERATURE:** -40°F to +212°F (-40°C to +100°C) continuous service.

**CONSTRUCTION:**  
**Tube:** Type C (Nitrile). Black. Oil and heat-resistant.  
**Reinforcement:** Single ply of synthetic fabric and two built-in helical steel wires.  
**Cover:** Type A (Chloroprene). Black.  
**Design Factor:** 4:1

**STANDARDS:** Meets requirements of SAE 30R5.  
**Tube:** ARPM (Class B) Medium oil-resistance.  
**Cover:** ARPM (Class C) Limited oil-resistance.

AGRICULTURE
AIR BREATHING
AIR DUCT
AIR AND MULTI-PURPOSE
CHEMICAL
FOOD AND BEVERAGE
MARINE AND ENGINE
MATERIAL HANDLING
MINING
OILFIELD
PETROLEUM
PRESSURE WASH AND WASHDOWN
STEAM
WATER
CLAMPS
COUPLINGS AND FERRULES
HOSE FINDER
CHEMICAL RESISTANCE TABLE

## Windshield Washer and Vacuum Tubing



Color	Hose I.D.		Hose O.D.		Max. W.P.		Vac.	MBR	Wt. Per ea	Length	Std. Pack	Pkg Code	Stock or MTO	Gates Item No.	List Price Per ea
	(in)	(mm)	(in)	(mm)	(psi)	(Bar)									
Black	7/64	2.8	.22	5.6	25	1.7	24.0	1.5	1.00	50	Ctn	T	Stock	4040-4101	\$28.31
Black	5/32	4.0	.31	7.9	25	1.7	24.0	1.5	2.24	50	Ctn	T	Stock	4040-4104	40.82
Black	7/32	5.6	.42	10.7	25	1.7	24.0	2.0	3.66	50	Ctn	T	Stock	4040-4107	47.07
Black	1/4	6.4	.45	11.4	25	1.7	24.0	2.0	3.95	50	Ctn	T	Stock	4040-4110	54.60
Black	5/16	7.9	.50	12.7	25	1.7	24.0	2.5	1.74	25	Ctn	T	Stock	4040-4112	36.84
Black	3/8	9.5	.63	16.0	25	1.7	24.0	3.0	3.60	25	Ctn	T	Stock	4040-4113	50.91

**RECOMMENDED FOR:** Ideal for windshield washer systems and vacuum-operated accessories.

**TEMPERATURE:** -40°F to +257°F (-40°C to +125°C) continuous service.

**CONSTRUCTION:** Tube: Type P (EPDM). Black. Heat-resistant.  
Design Factor: NR

**STANDARDS:** Tested to SAE J1037.

AGRICULTURE

AIR BREATHING

AIR DUCT

AIR AND MULTI-PURPOSE

CHEMICAL

FOOD AND BEVERAGE

MARINE AND ENGINE

MATERIAL HANDLING

MINING

OILFIELD

PETROLEUM

PRESSURE WASH AND WASHDOWN

STEAM

WATER

CLAMPS

COUPLINGS AND FERRULES

HOSE FINDER

CHEMICAL RESISTANCE TABLE



## Material Handling Hose

### Bulk Master™ Dry Cement (20-75) D Formerly - 609W



#### 1/4" Tube Thickness (XTreme™)

Color	Hose I.D.		Hose O.D.		Max. W.P.		Vac.	MBR	Wt. Per ft	Length	Std. Pack	Pkg Code	Stock or MTO (ft)	Gates Item No.	List Price Per ft
	(in)	(mm)	(in)	(mm)	(psi)	(Bar)									
Black	4	101.6	4.73	120.1	60	4.1	—	48.0	2.71	100	PLT	T	Stock	3129-0570	\$39.38

#### 3/16" Tube Thickness (Plus)

Color	Hose I.D.		Hose O.D.		Max. W.P.		Vac.	MBR	Wt. Per ft	Length	Std. Pack	Pkg Code	Stock or MTO (ft)	Gates Item No.	List Price Per ft
	(in)	(mm)	(in)	(mm)	(psi)	(Bar)									
Black	4	101.6	4.61	117.1	60	4.1	—	48.0	2.11	100	PLT	T	Stock	3129-0790	\$34.83

#### 1/8" Tube Thickness

Color	Hose I.D.		Hose O.D.		Max. W.P.		Vac.	MBR	Wt. Per ft	Length	Std. Pack	Pkg Code	Stock or MTO (ft)	Gates Item No.	List Price Per ft
	(in)	(mm)	(in)	(mm)	(psi)	(Bar)									
Black	3	76.2	3.47	88.1	75	5.2	—	36.0	1.30	100	PLT	T	Stock	3129-0660	\$26.01
Black	4	101.6	4.47	113.5	75	5.2	—	48.0	1.71	100	PLT	T	Stock	3129-0670	30.29
Black	4	101.6	4.47	113.5	75	5.2	—	48.0	1.69	200	PLT	T	MTO	3129-0672	30.29
Black	4 1/2	114.3	4.97	126.2	35	2.4	—	54.0	1.92	100	PLT	T	Stock	3129-0675	32.72
Black	5	127.0	5.47	138.9	75	5.2	—	60.0	2.12	100	PLT	T	Stock	3129-0680	35.79
Black	6	152.4	6.47	164.3	25	1.7	—	72.0	2.51	100	PLT	T	Stock	3129-0690	42.78
Black	6 5/8	168.3	7.10	180.3	20	1.4	—	72.0	2.35	100	PLT	T	MTO	3129-0700	48.17

**RECOMMENDED FOR:** Pneumatic transfer of bulk cement and other dry bulk materials.

**TEMPERATURE:** -40°F to +150°F (-40°C to +66°C) continuous service.

**CONSTRUCTION:** **Tube:** Type D3 (Natural Rubber). Black. Static-conductive.  
**Reinforcement:** Synthetic, high tensile textile.  
**Cover:** Type D (SBR). Black with gray stripe.  
**Design Factor:** 4:1

**COUPLINGS:** 5, 7, 49 or 78. Reference the Hose Coupling Section.

AGRICULTURE

AIR BREATHING

AIR DUCT

AIR AND MULTI-PURPOSE

CHEMICAL

FOOD AND BEVERAGE

MARINE AND ENGINE

MATERIAL HANDLING

MINING

OILFIELD

PETROLEUM

PRESSURE WASH AND WASHDOWN

STEAM

WATER

CLAMPS

COUPLINGS AND FERRULES

HOSE FINDER

CHEMICAL RESISTANCE TABLE

## Material Handling Hose

### Bulk Master™ Plus (35-60) SD

Formerly - 688SB



Color	Hose I.D.		Hose O.D.		Max. W.P.		Vac.	MBR	Wt. Per ft	Length	Std. Pack	Pkg Code	Stock or MTO	Gates Item No.	List Price Per ft
	(in)	(mm)	(in)	(mm)	(psi)	(Bar)									
Black	2	50.8	2.77	70.4	60	4.1	30.0	16.0	1.74	100	PLT	T	Stock	4691-0305	\$37.05
Black	2	50.8	2.77	70.4	60	4.1	30.0	16.0	1.74	200	PLT	T	MTO	4691-0306	37.05
Black	2 1/2	63.5	3.27	83.1	60	4.1	30.0	20.0	1.65	100	PLT	T	MTO	4691-0320	50.58
Black	3	76.2	3.81	96.8	60	4.1	30.0	24.0	2.66	100	PLT	T	Stock	4691-0325	50.87
Black	4	101.6	4.77	121.2	45	3.1	30.0	32.0	3.37	100	PLT	T	Stock	4691-0340	66.39
Black	4	101.6	4.77	121.2	45	3.1	30.0	32.0	3.37	200	PLT	T	MTO	4691-4342	66.39
Black	4 1/2	114.3	5.27	133.9	40	2.8	30.0	36.0	3.70	50	PLT	T	Stock	4691-0355	78.99
Black	5	127.0	5.77	146.6	40	2.8	30.0	40.0	4.14	50	PLT	T	Stock	4691-0360	85.80
Black	6	152.4	6.76	171.7	40	2.8	30.0	48.0	5.07	50	PLT	T	Stock	4691-0346	93.35
Black	6	152.4	6.76	171.7	40	2.8	30.0	48.0	5.07	200	PLT	T	MTO	4691-0349	93.35
Black	6 5/8	168.3	7.47	189.7	35	2.4	30.0	36.0	5.36	50	PLT	T	MTO	4691-0370	138.53

**RECOMMENDED FOR:** Transfer of bulk materials via suction, gravity or pneumatic systems where abrasion resistance is the primary requirement. Examples: Dry cement, sand, gravel, feed, seed and slurries.

**TEMPERATURE:** -40°F to +150°F (-40°C to +66°C) continuous service.

**CONSTRUCTION:** **Tube:** Type D3 (Natural Rubber). Black. Static-conductive. 3/16" thick.  
**Reinforcement:** Synthetic, high tensile textile with steel wire helix.  
**Cover:** Type D (SBR). Black corrugated with gray stripe.  
**Design Factor:** 4:1

**COUPLINGS:** 5, 6, 7, 49 or 78. Reference the Hose Coupling Section.

AGRICULTURE

AIR BREATHING

AIR DUCT

AIR AND MULTI-PURPOSE

CHEMICAL

FOOD AND BEVERAGE

MARINE AND ENGINE

MATERIAL HANDLING

MINING

OILFIELD

PETROLEUM

PRESSURE WASH AND WASHDOWN

STEAM

WATER

CLAMPS

COUPLINGS AND FERRULES

HOSE FINDER

CHEMICAL RESISTANCE TABLE

## Material Handling Hose

### Bulk Master™ Hot Air Blower (40-130) SD HT



AGRICULTURE
AIR BREATHING
AIR DUCT
AIR AND MULTI-PURPOSE
CHEMICAL
FOOD AND BEVERAGE
MARINE AND ENGINE
MATERIAL HANDLING
MINING
OILFIELD
PETROLEUM
PRESSURE WASH AND WASHDOWN
STEAM
WATER
CLAMPS
COUPLINGS AND FERRULES
HOSE FINDER
CHEMICAL RESISTANCE TABLE

Color	Hose I.D.		Hose O.D.		Max. W.P.		Vac.	MBR	Wt. Per ft	Length	Std. Pack	Pkg Code	Stock or MTO	Gates Item No.	List Price Per ft
	(in)	(mm)	(in)	(mm)	(psi)	(Bar)									
Black	1 1/2	38.1	2.08	52.8	130	9.0	30.0	8.0	.89	100	PLT	T	Stock	4691-0501	\$24.03
Black	2	50.8	2.58	65.5	125	8.6	30.0	9.0	1.00	100	PLT	T	Stock	4691-0502	26.33
Black	2 1/2	63.5	3.08	78.2	110	7.6	30.0	14.0	1.43	100	PLT	T	Stock	4691-0503	31.50
Black	3	76.2	3.64	92.5	100	6.9	30.0	18.0	1.63	100	PLT	T	Stock	4691-0504	37.22
Black	3 1/2	88.9	4.14	105.2	85	5.9	30.0	21.0	1.95	100	PLT	T	MTO	4691-0505	42.06
Black	4	101.6	4.64	117.9	75	5.2	30.0	24.0	2.21	100	PLT	T	Stock	4691-0506	46.22
Black	5	127.0	5.74	145.8	55	3.8	30.0	30.0	3.13	100	PLT	T	MTO	4691-0507	61.89
Black	6	152.4	6.74	171.2	40	2.8	30.0	36.0	4.54	100	PLT	T	MTO	4691-0508	71.16

**RECOMMENDED FOR:** Conveying hot air up to +350°F from blower or compressor to storage tank used in the transfer of dry bulk commodities. Can also be used for transferring mild chemicals at ambient temperatures.

**CAUTION:** -40°F to +125°F (-40°C to +52°C) for mild chemical transfer. For chemicals above +125°F or suitability for use with a specific chemical, contact Denver Product Application at (303) 744-5070.

**TEMPERATURE:** -40°F to +350°F (-40°C to +177°C) for hot air service.

**CONSTRUCTION:**  
**Tube:** Type P (EPDM). Black.  
**Reinforcement:** Synthetic, high tensile textile with steel wire helix.  
**Cover:** Type P (EPDM). Black with gray stripe.  
**Design Factor:** 4:1

**COUPLINGS:** 5, 7 or 49. Block 49 (Cam and Groove) should not be used for compressed air service and are not recommended for high temperature service. Reference the Hose Coupling Section.

## Material Handling Hose

### Bulk Master™ (4-24) SD

Formerly - 770SB



Color	Hose I.D.		Hose O.D.		Max. W.P.		Vac.	MBR	Wt. Per ft	Length	Std. Pack	Pkg Code	Stock or MTO	Gates Item No.	List Price Per ft
	(in)	(mm)	(in)	(mm)	(psi)	(Bar)									
Black	1	25.4	1.39	35.3	4	.3	20.0	5.0	.49	100	PLT	T	MTO	4691-0400	\$21.30
Black	1 1/4	31.8	1.64	41.7	5	.3	20.0	5.0	.59	100	PLT	T	Stock	4691-0405	21.53
Black	1 1/2	38.1	1.89	48.0	6	.4	20.0	6.0	.68	100	PLT	T	Stock	4691-0410	21.99
Black	2	50.8	2.39	60.7	8	.6	20.0	8.0	.75	100	PLT	T	Stock	4691-0420	22.73
Black	2 1/2	63.5	2.89	73.4	9	.6	20.0	9.0	.91	100	PLT	T	MTO	4691-0430	24.36
Black	3	76.2	3.39	86.1	12	.8	20.0	10.0	1.03	100	PLT	T	Stock	4691-0435	26.85
Black	4	101.6	4.39	111.5	16	1.1	20.0	15.0	1.35	100	PLT	T	MTO	4691-0440	37.58
Black	5	127.0	5.53	140.5	20	1.4	20.0	20.0	2.27	50	PLT	T	Stock	4691-0450	58.38
Black	6	152.4	6.53	165.9	24	1.7	20.0	24.0	3.20	50	PLT	T	MTO	4691-0455	72.21

**RECOMMENDED FOR:** Light-duty vacuum service in industrial and maintenance applications conveying air, dust, fine particles, leaves, grass, etc.

**TEMPERATURE:** -40°F to +150°F (-40°C to +66°C) continuous service.

**CONSTRUCTION:** **Tube:** Type D3 (Natural Rubber). Black. Static-conductive.  
**Reinforcement:** Synthetic, high tensile textile with steel wire helix.  
**Cover:** Type D (SBR). Black corrugated with gray stripe.  
**Design Factor:** 4:1

**COUPLINGS:** 5, 6, 7 or 78. Reference the Hose Coupling Section.

AGRICULTURE

AIR BREATHING

AIR DUCT

AIR AND MULTI-PURPOSE

CHEMICAL

FOOD AND BEVERAGE

MARINE AND ENGINE

MATERIAL HANDLING

MINING

OILFIELD

PETROLEUM

PRESSURE WASH AND WASHDOWN

STEAM

WATER

CLAMPS

COUPLINGS AND FERRULES

HOSE FINDER

CHEMICAL RESISTANCE TABLE

## Material Handling Hose

### Bulk Master™ Sand Blast (120-150) D

Formerly - 429W



AGRICULTURE
AIR BREATHING
AIR DUCT
AIR AND MULTI-PURPOSE
CHEMICAL
FOOD AND BEVERAGE
MARINE AND ENGINE
MATERIAL HANDLING
MINING
OILFIELD
PETROLEUM
PRESSURE WASH AND WASHDOWN
STEAM
WATER
CLAMPS
COUPLINGS AND FERRULES
HOSE FINDER
CHEMICAL RESISTANCE TABLE

Color	Hose I.D.		Hose O.D.		Max. W.P.		Vac.	MBR	Wt. Per ft	Length	Std. Pack	Pkg Code	Stock or MTO	Gates Item No.	List Price Per ft
	(in)	(mm)	(in)	(mm)	(psi)	(Bar)									
Black	1/2	12.7	1.23	31.2	150	10.3	25.0	5.0	.55	50	PLT	T	Stock	4129-0085	\$11.46
Black	3/4	19.1	1.50	38.1	150	10.3	15.0	8.0	.70	50	PLT	T	Stock	4129-0086	15.00
Black	1	25.4	1.63	41.4	150	10.3	5.0	12.0	.70	50	PLT	T	Stock	4129-0256	18.53
Black	1	25.4	1.87	47.5	150	10.3	5.0	12.0	.96	50	PLT	T	Stock	4129-0100	21.09
Black	1 1/4	31.8	2.16	54.9	150	10.3	5.0	12.0	1.12	50	PLT	T	Stock	4129-0105	25.32
Black	1 1/2	38.1	2.37	60.2	135	9.3	5.0	18.0	1.56	50	PLT	T	Stock	4129-0150	28.20
Black	2	50.8	2.94	74.7	120	8.3	5.0	20.0	2.00	50	PLT	T	Stock	4129-0200	35.72

**RECOMMENDED FOR:** Sand, shot-blasting work and wherever abrasive materials are carried at high velocity.

**TEMPERATURE:** -40°F to +150°F (-40°C to +66°C) continuous service.

**CONSTRUCTION:** **Tube:** Type D3 (Natural Rubber). Black. Static-conductive.  
**Reinforcement:** Synthetic, high tensile textile.  
**Cover:** Type D (SBR). Black with gray stripe. All sizes are perforated.  
**Design Factor:** 4:1

**COUPLINGS:** 36. Reference the Hose Coupling Section.

## Material Handling Hose

### Bulk Master™ PVC (25-40) SD AR Formerly - Master-Flex® 400



Color	Hose I.D.		Hose O.D.		Max. W.P.*		Vac.*	MBR	Wt. Per ft	Length	Std. Pack	Pkg Code	Stock or MTO	Gates Item No.	List Price Per ft
	(in)		(mm)		(in)								(mm)		
Black	1 1/2	38.1	1.88	47.8	40	2.8	28.0	3.0	.38	100	PLT	T	MTO	7744-6102	\$9.29
Black	2	50.8	2.41	61.2	35	2.4	28.0	4.0	.54	100	PLT	T	Stock	7744-6103	13.35
Black	2 1/2	63.5	2.98	75.7	35	2.4	28.0	5.0	.77	100	PLT	T	Stock	7744-6104	18.18
Black	3	76.2	3.87	98.3	30	2.1	28.0	6.0	1.05	100	PLT	T	Stock	7744-6105	23.75
Black	4	101.6	4.65	118.1	30	2.1	28.0	8.0	1.70	100	PLT	T	Stock	7744-6106	40.71
Black	5	127.0	5.77	146.6	30	2.1	28.0	9.0	2.40	100	PLT	T	Stock	7744-6107	63.32
Black	6	152.4	6.86	174.2	25	1.7	28.0	12.0	3.21	100	PLT	T	Stock	7744-6108	73.05
Black	8	203.2	9.10	231.1	25	1.7	28.0	16.0	5.77	50	PLT	T	Stock	7744-6209	83.42

NOTE: \* Working Pressure and Vacuum at +72°F (+22°C).

**RECOMMENDED FOR:** Transfer of bulk materials via suction, pneumatic or gravity systems where tube abrasion resistance is the primary requirement and a static-conductive hose is needed. Can also be used for vacuum or ducting service.

**TEMPERATURE:** -30°F to +140°F (-34°C to +60°C) continuous service.

**CONSTRUCTION: Tube:** Type C (Nitrile) blend. Static conductive.  
Type D (SBR).

**Reinforcement:** Rigid PVC helix. Black.

**Cover:** Type G (PVC). Black with gray helix. Corrugated.

**Design Factor:** 3:1

**COUPLINGS:** 1, 6, 7, 49 or 78. Reference the Hose Coupling Section.

**STANDARDS: Tube:** ARPM (Class B) Medium oil-resistance.

AGRICULTURE

AIR BREATHING

AIR DUCT

AIR AND MULTI-PURPOSE

CHEMICAL

FOOD AND BEVERAGE

MARINE AND ENGINE

MATERIAL HANDLING

MINING

OILFIELD

PETROLEUM

PRESSURE WASH AND WASHDOWN

STEAM

WATER

CLAMPS

COUPLINGS AND FERRULES

HOSE FINDER

CHEMICAL RESISTANCE TABLE

## Mining Hose

### Mine Master™ Spray 1000

Formerly - 1000 MP/Mine Spray



AGRICULTURE
AIR BREATHING
AIR DUCT
AIR AND MULTI-PURPOSE
CHEMICAL
FOOD AND BEVERAGE
MARINE AND ENGINE
MATERIAL HANDLING
MINING
OILFIELD
PETROLEUM
PRESSURE WASH AND WASHDOWN
STEAM
WATER
CLAMPS
COUPLINGS AND FERRULES
HOSE FINDER
CHEMICAL RESISTANCE TABLE

Color	Hose I.D.		Hose O.D.		Max. W.P.		Vac.	MBR	Wt. Per ft	Length	Std. Pack	Pkg Code	Stock or MTO	Gates Item No.	List Price Per ft
	(in)		(mm)		(in)								(mm)		
Yellow	1/2	12.7	.84	21.3	1000	68.9	30.0	5.0	.29	50	Ctn	T	Stock	3619-0699	\$7.82
Yellow	1/2	12.7	.84	21.3	1000	68.9	30.0	5.0	.29	50	Bulk	1200	MTO	3619-0761	7.44
Yellow	1/2	12.7	.84	21.3	1000	68.9	30.0	5.0	.29	100	Ctn	T	Stock	3619-0716	7.82
Yellow	3/4	19.1	1.10	27.9	1000	68.9	25.0	8.0	.43	50	Ctn	T	Stock	3619-0700	8.76
Yellow	3/4	19.1	1.10	27.9	1000	68.9	25.0	8.0	.43	50	Bulk	850	MTO	3619-0762	8.34
Yellow	3/4	19.1	1.10	27.9	1000	68.9	25.0	8.0	.43	100	Ctn	T	Stock	3619-0721	8.76
Yellow	3/4	19.1	1.10	27.9	1000	68.9	25.0	8.0	.43	100	Bulk	1000	MTO	3619-0789	5.56
Yellow	1	25.4	1.42	36.1	1000	68.9	25.0	11.0	.66	50	Ctn	T	Stock	3619-0701	10.44
Yellow	1	25.4	1.42	36.1	1000	68.9	25.0	11.0	.66	50	Bulk	700	MTO	3619-0763	9.95
Yellow	1	25.4	1.42	36.1	1000	68.9	25.0	11.0	.66	100	Ctn	T	Stock	3619-0786	10.44
Yellow	1	25.4	1.42	36.1	1000	68.9	25.0	11.0	.66	100	Bulk	400	MTO	3619-0790	9.95
Yellow	1 1/4	31.8	1.69	42.9	1000	68.9	20.0	16.0	.81	50	Ctn	T	Stock	3619-0702	15.17
Yellow	1 1/4	31.8	1.69	42.9	1000	68.9	20.0	16.0	.81	50	Bulk	300	Stock	3619-0764	14.45
Yellow	1 1/4	31.8	1.69	42.9	1000	68.9	20.0	16.0	.81	100	Ctn	T	Stock	3619-0787	15.17
Yellow	1 1/4	31.8	1.69	42.9	1000	68.9	20.0	16.0	.81	100	Bulk	100	MTO	3619-0791	9.63
Yellow	1 1/2	38.1	1.92	48.8	1000	68.9	15.0	18.0	1.07	50	Ctn	T	Stock	3619-0708	23.16
Yellow	1 1/2	38.1	1.92	48.8	1000	68.9	15.0	18.0	1.07	50	Bulk	250	Stock	3619-0765	22.05
Yellow	1 1/2	38.1	1.92	48.8	1000	68.9	15.0	18.0	1.07	100	Ctn	T	Stock	3619-0788	23.16
Yellow	1 1/2	38.1	1.92	48.8	1000	68.9	15.0	18.0	1.07	100	Bulk	200	MTO	3619-0792	22.05
Yellow	2	50.8	2.45	62.2	1000	68.9	10.0	25.0	1.47	50	Ctn	T	Stock	3619-0760	27.36
Yellow	2	50.8	2.45	62.2	1000	68.9	10.0	25.0	1.47	50	Bulk	200	Stock	3619-0766	26.06
Yellow	2	50.8	2.45	62.2	1000	68.9	10.0	25.0	1.47	100	Ctn	T	Stock	3619-0745	27.36

**RECOMMENDED FOR:** High-pressure water service in underground mining applications and hot water washdown service. The thick cover meets MSHA's self-extinguishing requirements, and is designed for the tough mining environment.

**CAUTION:** Air service working pressure is 300 psi for all sizes.

**TEMPERATURE:** -40°F to +212°F (-40°C to +100°C) service range.

**CONSTRUCTION:**  
**Tube:** Type P (EPDM). Black.  
**Reinforcement:** Braided, high tensile steel wire.  
**Cover:** Type C2 (Modified Nitrile). Yellow (non-marking). All sizes are perforated.  
**Design Factor:** 4:1

**COUPLINGS:** 80 Gates GSP (1 1/2" or 2" only), 74 Gates MegaCrimp® (1/2" through 1 1/4"), 14, 15 or 19 (up to 300 PSI only). Reference the Hose Coupling Section.

**STANDARDS:** **Tube:** ARPM (Class C) Limited oil-resistance.  
**Cover:** ARPM (Class B) Medium oil-resistance. Meets MSHA Flame-resistant.

## Mining Hose

### Mine Master™ Longwall Emulsion 1000

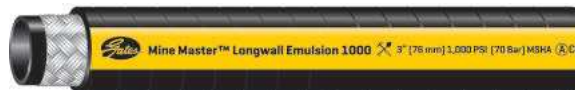

Color	Hose I.D.		Hose O.D.		Max. W.P.		Vac.	MBR	Wt. Per ft	Length	Std. Pack	Pkg Code	Stock or MTO	Gates Item No.	List Price Per ft
	(in)	(mm)	(in)	(mm)	(psi)	(Bar)									
Black	2 1/2	63.5	3.34	84.8	1000	68.9	10.0	20.0	3.17	50	Ctn	T	MTO	3619-0809	\$43.37
Black	2 1/2	63.5	3.34	84.8	1000	68.9	10.0	20.0	3.17	100	Ctn	T	MTO	3619-0811	47.70
Black	3	76.2	3.91	99.3	1000	68.9	10.0	20.0	4.14	50	Ctn	T	MTO	3619-0810	57.72
Black	3	76.2	3.91	99.3	1000	68.9	10.0	20.0	4.14	100	Ctn	T	Stock	3619-3531	63.50
Yellow	3	76.2	3.91	99.3	1000	68.9	10.0	20.0	4.14	50	Ctn	T	MTO	3619-0051	62.34
Yellow	3	76.2	3.91	99.3	1000	68.9	10.0	20.0	4.14	100	Ctn	T	MTO	3619-3530	68.58

**RECOMMENDED FOR:** Flexible connections in high-pressure water distribution and emulsion systems used in a variety of industries. The thick cover meets MSHA's self-extinguishing requirements, and is designed for the tough mining environment.

**TEMPERATURE:** -40°F to +212°F (-40°C to +100°C) normal service.

**CONSTRUCTION:**  
**Tube:** Type A (Chloroprene). Black.  
**Reinforcement:** Braided, high tensile steel wire.  
**Cover:** Type C2 (Modified Nitrile). Yellow.  
 Type C2 (Specially compounded elastomer). Black with yellow stripe.  
**Design Factor:** 4:1

**COUPLINGS:** 14, 15 or reusable male couplings (Wildman). Reference the Hose Coupling Section.

**STANDARDS:**  
**Tube:** ARPM (Class B) Medium oil-resistance.  
**Cover:** ARPM (Class B) Medium oil-resistance. Meets MSHA Flame-resistant.

AGRICULTURE

AIR BREATHING

AIR DUCT

AIR AND MULTI-PURPOSE

CHEMICAL

FOOD AND BEVERAGE

MARINE AND ENGINE

MATERIAL HANDLING

MINING

OILFIELD

PETROLEUM

PRESSURE WASH AND WASHDOWN

STEAM

WATER

CLAMPS

COUPLINGS AND FERRULES

HOSE FINDER

CHEMICAL RESISTANCE TABLE



## Mining Hose

### Mine Master™ Air Drill 600HT Formerly - Scorpion™



Color	Hose I.D.	Hose O.D.	Max. W.P.	Vac.	MBR	Wt. Per ft	Length	Std. Pack	Pkg Code	Stock or MTO	Gates Item No.	List Price Per ft			
	(in)	(mm)											(in)	(mm)	(psi)
Black	1 1/2	38.1	2.02	51.3	600	41.4	—	12.0	1.13	50	Ctn	QQ	Stock	3618-0311	\$60.59
	2	50.8	2.62	66.5	600	41.4	—	16.0	1.51	50	Ctn	QQ	Stock	3618-0312	64.77
	2	50.8	2.62	66.5	600	41.4	—	16.0	1.63	50	Ctn	T	MTO	3618-0336	68.01
Black	2 1/2	63.5	3.12	79.2	600	41.4	—	18.0	1.89	50	Ctn	QQ	Stock	3618-0313	68.94
	3	76.2	3.64	92.5	600	41.4	—	20.0	2.46	50	Ctn	QQ	Stock	3618-0314	73.13
	3	76.2	3.64	92.5	600	41.4	—	18.0	2.62	50	Ctn	T	MTO	3618-0333	76.79
Black	4	101.6	4.79	121.7	600	41.4	—	25.0	4.10	50	Ctn	QQ	MTO	3618-0315	89.04

**RECOMMENDED FOR:** High-pressure and high-temperature air hose used on industrial, construction, pneumatic mining and drilling applications requiring a wire-braided hose with a high-temperature thick rubber cover.

**TEMPERATURE:** -40°F to +300°F (-40°C to +149°C).

**CONSTRUCTION:**  
**Tube:** Type J (CPE). Black.  
**Reinforcement:** Braided, high tensile steel wire.  
**Cover:** Type J (CPE). Black with yellow stripe. All sizes perforated.  
**Design Factor:** 4:1

**COUPLINGS:** 14, 15, 18, 35, 71 Permanent Swaged or 80 Gates GSP (1 1/2" or 2" only). Reference the Hose Coupling Section.

**STANDARDS:**  
**Tube:** ARPM (Class B) Medium oil-resistance.  
**Cover:** ARPM (Class B) Medium oil-resistance.

AGRICULTURE
AIR BREATHING
AIR DUCT
AIR AND MULTI-PURPOSE
CHEMICAL
FOOD AND BEVERAGE
MARINE AND ENGINE
MATERIAL HANDLING
MINING
OILFIELD
PETROLEUM
PRESSURE WASH AND WASHDOWN
STEAM
WATER
CLAMPS
COUPLINGS AND FERRULES
HOSE FINDER
CHEMICAL RESISTANCE TABLE

## Mining Hose

### Mine Master™ Air Drill 500 Formerly - 18MB



Color	Hose I.D.		Hose O.D.		Max. W.P.		Vac.	MBR	Wt. Per ft	Length	Std. Pack	Pkg Code	Stock or MTO	Gates Item No.	List Price Per ft
	(in)	(mm)	(in)	(mm)	(psi)	(Bar)									
Gray	3/4	19.1	1.28	32.5	500	34.5	25.0	6.0	.41	50	Ctn	T	Stock	3618-0011	\$17.96
Gray	1	25.4	1.55	39.4	500	34.5	25.0	8.0	.80	50	Ctn	T	MTO	3618-0021	20.85
Gray	1 1/4	31.8	1.80	45.7	500	34.5	15.0	10.0	1.02	50	Ctn	T	MTO	3618-0031	25.91
Gray	1 1/2	38.1	2.21	56.1	500	34.5	15.0	12.0	1.42	50	Ctn	T	Stock	3618-0041	33.89
Gray	2	50.8	2.77	70.4	500	34.5	15.0	14.0	2.30	50	Ctn	T	Stock	3618-0051	47.99
Gray	2	50.8	2.77	70.4	500	34.5	15.0	14.0	1.26	60	Ctn	T	MTO	3618-0052	47.99
Gray	2	50.8	2.77	70.4	500	34.5	15.0	14.0	1.99	100	Ctn	T	MTO	3618-1000	47.99
Gray	2 1/2	63.5	3.46	87.9	500	34.5	10.0	30.0	3.28	50	Ctn	T	Stock	3618-0201	58.41
Gray	2 1/2	63.5	3.46	87.9	500	34.5	10.0	30.0	3.28	60	Ctn	T	Stock	3618-0205	58.41
Gray	3	76.2	3.97	100.8	500	34.5	10.0	36.0	4.10	50	Ctn	T	Stock	3618-0215	70.76
Gray	4	101.6	5.06	128.5	500	34.5	10.0	47.6	5.32	50	Ctn	T	Stock	3618-0225	94.40

**RECOMMENDED FOR:** Extra heavy-duty, high-pressure use on industrial, construction and pneumatic mining applications requiring wire-braided hose with an oil-resistant tube and abrasion-resistant cover.

**TEMPERATURE:** -30°F to +212°F (-34°C to +100°C) continuous service.

**CONSTRUCTION:**  
**Tube:** Type A (Chloroprene). Black.  
**Reinforcement:** Braided, high tensile steel wire.  
**Cover:** Type C2 (Modified Nitrile). Gray with yellow stripe. All sizes are perforated. For 3/4" through 1 1/4" sizes only.  
 Type D3 (Natural Rubber). Gray with yellow stripe. All sizes are perforated. For 1 1/2" through 4" sizes only.  
**Design Factor:** 4:1

**COUPLINGS:** 14, 15, 18, 35 or 80 Gates GSP (1 1/2" or 2" only). Reference the Hose Coupling Section.

**STANDARDS:**  
**Tube:** ARPM (Class B) Medium oil-resistance.  
**Cover:** ARPM (Class C) Limited oil-resistance.

AGRICULTURE

AIR BREATHING

AIR DUCT

AIR AND MULTI-PURPOSE

CHEMICAL

FOOD AND BEVERAGE

MARINE AND ENGINE

MATERIAL HANDLING

MINING

OILFIELD

PETROLEUM

PRESSURE WASH AND WASHDOWN

STEAM

WATER

CLAMPS

COUPLINGS AND FERRULES

HOSE FINDER

CHEMICAL RESISTANCE TABLE

## Mining Hose

### Mine Master™ Air Drill 500 FR Formerly - 500 MP Air Drill



Color	Hose I.D.		Hose O.D.		Max. W.P.		Vac.	MBR	Wt. Per ft	Length	Std. Pack	Pkg Code	Stock or MTO	Gates Item No.	List Price Per ft
	(in)	(mm)	(in)	(mm)	(psi)	(Bar)	(In. Hg)	(in)	(Lbs.)	(ft)			(ft)		
Black	3/4	19.1	1.11	28.2	500	34.5	25.0	6.0	.41	100	Ctn	T	Stock	3618-0801	\$13.47
Black	1	25.4	1.45	36.8	500	34.5	25.0	8.0	.66	100	Ctn	T	Stock	3618-0802	15.65
Black	1 1/4	31.8	1.74	44.2	500	34.5	15.0	10.0	.86	100	Ctn	T	Stock	3618-0803	19.43
Black	1 1/2	38.1	1.99	50.5	500	34.5	15.0	12.0	1.00	100	Ctn	T	Stock	3618-0804	25.40
Black	2	50.8	2.50	63.5	500	34.5	15.0	14.0	1.39	100	Ctn	T	Stock	3618-0805	36.00
Black	2 1/2	63.5	3.14	79.8	500	34.5	10.0	30.0	2.15	100	Ctn	T	MTO	3618-0806	43.82
Black	3	76.2	3.67	93.2	500	34.5	10.0	36.0	2.77	100	Ctn	T	MTO	3618-0807	53.09
Yellow	3/4	19.1	1.11	28.2	500	34.5	25.0	6.0	.41	100	Ctn	T	Stock	3618-0808	14.36
Yellow	1	25.4	1.45	36.8	500	34.5	25.0	8.0	.65	100	Ctn	T	Stock	3618-0809	16.70
Yellow	1 1/4	31.8	1.74	44.2	500	34.5	15.0	10.0	.85	100	Ctn	T	MTO	3618-0810	20.75
Yellow	1 1/2	38.1	1.99	50.5	500	34.5	15.0	12.0	1.00	100	Ctn	T	Stock	3618-0811	27.08
Yellow	2	50.8	2.50	63.5	500	34.5	15.0	14.0	1.39	100	Ctn	T	Stock	3618-0812	38.39
Yellow	2 1/2	63.5	3.14	79.8	500	34.5	10.0	30.0	2.15	100	Ctn	T	MTO	3618-0813	46.76
Yellow	3	76.2	3.67	93.2	500	34.5	10.0	36.0	2.77	100	Ctn	T	MTO	3618-0814	56.60

NOTE: For 4" I.D. see Mine Master™ Air Drill.

**RECOMMENDED FOR:** Heavy-duty, high-pressure use on industrial, construction and pneumatic mining applications requiring wire-braided hose with an oil-resistant tube and abrasion-resistant cover.

**TEMPERATURE:** -22°F to +180°F (-30°C to +82°C) continuous service.

**CONSTRUCTION:** **Tube:** Type C (Nitrile). Black.  
**Reinforcement:** Braided, high tensile steel wire.  
**Cover:** Type C2 (Modified Nitrile). Black with yellow stripe. All sizes are perforated.  
Type C2 (Modified Nitrile). Yellow with black stripe. All sizes are perforated.  
**Design Factor:** 4:1

**COUPLINGS:** 14, 15, 18, 35 or 80 Gates GSP (1 1/2" or 2" only). Reference the Hose Coupling Section.

**STANDARDS:** **Tube:** ARPM (Class B) Medium oil-resistance.  
**Cover:** ARPM (Class B) Medium oil-resistance. Meets MSHA Flame-resistant.

## Mining Hose

### Mine Master™ Rock Dust 100SD



Color	Hose I.D.		Hose O.D.		Max. W.P.		Vac.	MBR	Wt. Per ft	Length	Std. Pack	Pkg Code	Stock or MTO	Gates Item No.	List Price Per ft
	(in)	(mm)	(in)	(mm)	(psi)	(Bar)									
Black	1 1/4	31.8	1.67	42.4	100	6.9	30.0	6.0	.56	100	PLT	T	Stock	4691-0700	\$17.72
Black	1 1/2	38.1	1.92	48.8	100	6.9	30.0	8.0	.66	100	PLT	T	MTO	4691-0701	17.91
Black	2	50.8	2.41	61.2	100	6.9	30.0	10.0	.89	100	PLT	T	MTO	4691-0702	18.15
Black	2 1/2	63.5	2.92	74.2	100	6.9	30.0	12.0	.98	100	PLT	T	Stock	4691-0703	23.49
Black	3	76.2	3.41	86.6	100	6.9	30.0	15.0	1.29	100	PLT	T	Stock	4691-0704	24.09

**RECOMMENDED FOR:** Rock dusting applications in underground coal mines where limestone dust (or other inert rock-derived dusting agent) is sprayed in order to isolate exposed coal surfaces from potential heat or ignition sources. Lightweight and flexible for easy handling.

**TEMPERATURE:** -40°F to +180°F (-40°C to +82°C).

**CONSTRUCTION:**  
**Tube:** Type D (Natural Rubber). Black. Static-conductive.  
**Reinforcement:** Synthetic, high tensile textile with steel wire helix.  
**Cover:** Type C2 (Modified Nitrile). Black with yellow stripe.  
**Design Factor:** 4:1

**COUPLINGS:** 1, 6, 7, 21, 49 or 78. Reference the Hose Coupling Section.

**STANDARDS:** **Cover:** Meets MSHA Flame-resistant.

AGRICULTURE

AIR BREATHING

AIR DUCT

AIR AND MULTI-PURPOSE

CHEMICAL

FOOD AND BEVERAGE

MARINE AND ENGINE

MATERIAL HANDLING

MINING

OILFIELD

PETROLEUM

PRESSURE WASH AND WASHDOWN

STEAM

WATER

CLAMPS

COUPLINGS AND FERRULES

HOSE FINDER

CHEMICAL RESISTANCE TABLE

## Black Gold® ABS Chemical Plus XLPE 250SD



AGRICULTURE
AIR BREATHING
AIR DUCT
AIR AND MULTI-PURPOSE
CHEMICAL
FOOD AND BEVERAGE
MARINE AND ENGINE
MATERIAL HANDLING
MINING
OILFIELD
PETROLEUM
PRESSURE WASH AND WASHDOWN
STEAM
WATER
CLAMPS
COUPLINGS AND FERRULES
HOSE FINDER
CHEMICAL RESISTANCE TABLE

Color	Hose I.D.		Hose O.D.		Max. W.P.		Vac.	MBR	Wt. Per ft	Length	Std. Pack	Pkg Code	Stock or MTO (ft)	Gates Item No.	List Price Per ft
	(in)	(mm)	(in)	(mm)	(psi)	(Bar)									
Black	1	25.4	1.50	38.1	250	17.2	30.0	5.0	.56	200	PLT	T	Stock	4695-0933	\$25.33
Black	2	50.8	2.58	65.5	250	17.2	30.0	10.0	1.19	200	PLT	T	Stock	4695-0934	39.39
Black	3	76.2	3.71	94.2	250	17.2	30.0	18.0	2.37	200	PLT	T	Stock	4695-0935	74.52
Black	4	101.6	4.70	119.4	250	17.2	30.1	24.0	3.05	200	PLT	T	Stock	4695-0936	89.76

**RECOMMENDED FOR:** Transfer of chemical products from a supply ship to an offshore drilling rig or platform; and for transfer applications on offshore or onshore drilling rigs or platforms. See Gates Chemical Resistance Table for proper hose selection.

**TEMPERATURE:** -40°F to +250°F (-40°C to +121°C).



**CONSTRUCTION:**  
**Tube:** Type K (Gatron™ Modified Cross-linked Polyethylene.)  
**Reinforcement:** Multiple plies of synthetic cord. Wire helix.  
**Cover:** Type P (EPDM). Black corrugated with purple stripe.  
**Design Factor:** 5:1

**COUPLINGS:** 71 (permanent crimp or swage). Reference the Hose Coupling Section.

**STANDARDS:** ABS approved.

## Black Gold® ABS Drill Water 300SD



Color	Hose I.D.		Hose O.D.		Max. W.P.		Vac.	MBR	Wt. Per ft	Length	Std. Pack	Pkg Code	Stock or MTO	Gates Item No.	List Price Per ft
	(in)	(mm)	(in)	(mm)	(psi)	(Bar)	(In. Hg)	(in)	(Lbs.)	(ft)			(ft)		
Black	2	50.8	2.62	66.5	300	20.7	30.0	12.0	1.19	200	PLT	T	Stock	4686-0028	\$21.84
Black	3	76.2	3.62	91.9	300	20.7	30.0	24.0	2.62	200	PLT	T	Stock	4686-0029	35.29
Black	4	101.6	4.62	117.3	300	20.7	30.0	30.0	3.18	200	PLT	T	Stock	4686-0030	44.81
Black	5	127.0	5.92	150.4	300	20.7	30.0	48.0	5.05	100	PLT	T	Stock	4686-0066	67.52
Black	6	152.4	6.92	175.8	300	20.7	30.0	60.0	7.53	100	PLT	T	Stock	4686-0067	91.92

**RECOMMENDED FOR:** Transfer of non-potable water or liquids not containing oils or chemicals from a supply ship to an offshore drilling rig or platform. Various water-based transfer applications for offshore or onshore work sites. The heavy-duty reinforcement is designed to survive extreme oilfield application requirements. The specially compounded cover material is designed to withstand the harshest environment including abrasion and weathering.

**CAUTION:** Not for drinking water or food products.

**TEMPERATURE:** -40°F to +150°F (-40°C to +66°C) continuous service.

**CONSTRUCTION:** **Tube:** Type P (EPDM). Black.  
**Reinforcement:** Synthetic, high tensile textile with steel wire helix.  
**Cover:** Type P (EPDM). Black with green stripe.  
**Design Factor:** 4:1

**COUPLINGS:** Crimped or swaged couplings. 71. Reference the Hose Coupling Section.

**STANDARDS:** ABS approved.

AGRICULTURE

AIR BREATHING

AIR DUCT

AIR AND MULTI-PURPOSE

CHEMICAL

FOOD AND BEVERAGE

MARINE AND ENGINE

MATERIAL HANDLING

MINING

OILFIELD

PETROLEUM

PRESSURE WASH AND WASHDOWN

STEAM

WATER

CLAMPS

COUPLINGS AND FERRULES

HOSE FINDER

CHEMICAL RESISTANCE TABLE

**Black Gold® ABS Drill Water 300D**



AGRICULTURE
AIR BREATHING
AIR DUCT
AIR AND MULTI-PURPOSE
CHEMICAL
FOOD AND BEVERAGE
MARINE AND ENGINE
MATERIAL HANDLING
MINING
OILFIELD
PETROLEUM
PRESSURE WASH AND WASHDOWN
STEAM
WATER
CLAMPS
COUPLINGS AND FERRULES
HOSE FINDER
CHEMICAL RESISTANCE TABLE

Color	Hose I.D.	Hose O.D.	Max. W.P.	Vac.	MBR	Wt. Per ft	Length	Std. Pack	Pkg Code	Stock or MTO	Gates Item No.	List Price Per ft			
	(in)	(mm)											(in)	(mm)	(psi)
Black	2	50.8	2.58	65.5	300	20.7	10.0	14.0	.94	200	PLT	T	Stock	3137-1280	\$21.88
Black	3	76.2	3.64	92.5	300	20.7	10.0	21.0	1.49	200	PLT	T	Stock	3137-1281	29.57
Black	4	101.6	4.64	117.9	300	20.7	10.0	28.0	1.94	200	PLT	T	Stock	3137-1282	36.00
Black	5	127.0	5.78	146.8	300	20.7	10.0	48.0	2.85	100	PLT	T	Stock	3137-1302	54.64
Black	6	152.4	6.82	173.2	300	20.7	10.0	60.0	2.85	100	PLT	T	Stock	3137-1303	69.37

**RECOMMENDED FOR:** Transfer of non-potable water or liquids not containing oils or chemicals from a supply ship to an offshore drilling rig or platform. Various water-based transfer applications for offshore or onshore work sites. The heavy-duty reinforcement is designed to survive extreme oilfield application requirements. The specially compounded cover material is designed to withstand the harshest environment including abrasion and weathering.

**CAUTION:** Not for drinking water or food products.

**TEMPERATURE:** -40°F to +150°F (-40°C to +66°C) continuous service.

**CONSTRUCTION:** **Tube:** Type P (EPDM). Black.  
**Reinforcement:** Synthetic, high tensile textile.  
**Cover:** Type P (EPDM). Black with green stripe.  
**Design Factor:** 4:1

**COUPLINGS:** Crimped or swaged couplings. 71. Reference the Hose Coupling Section.

**STANDARDS:** ABS approved.

# Black Gold® Slim Hole Rotary (1500-5000)

Formerly - Powerbraid® Plus



## 1,500 - 3,000 Working Pressure

Color	Hose I.D.		Hose O.D.		Max. W.P.		Vac.	MBR	Wt. Per ft	Length	Std. Pack	Pkg Code	Stock or MTO	Gates Item No.	List Price Per ft
	(in)	(mm)	(in)	(mm)	(psi)	(Bar)									
Black	2	50.8	2.63	66.8	3000	206.8	—	25.0	2.95	50	Ctn	T	Stock	3670-0655	\$100.49
Black	2	50.8	2.63	66.8	3000	206.8	—	25.0	2.95	200	Ctn	T	Stock	3670-0660	100.49
Black	2 1/2	63.5	3.38	85.9	2500	172.4	—	30.0	3.60	50	Ctn	T	Stock	3670-0656	117.06
Black	3	76.2	3.90	99.1	2000	137.9	—	36.0	4.74	50	Ctn	T	Stock	3670-0657	125.42
Black	4	101.6	5.06	128.5	1500	103.4	—	48.0	7.22	50	Ctn	T	Stock	3670-0701	156.77

## 5,000 Working Pressure

Color	Hose I.D.		Hose O.D.		Max. W.P.		Vac.	MBR	Wt. Per ft	Length	Std. Pack	Pkg Code	Stock or MTO	Gates Item No.	List Price Per ft
	(in)	(mm)	(in)	(mm)	(psi)	(Bar)									
Black	1	25.4	1.53	38.9	5000	344.7	—	12.0	1.49	200	Ctn	T	Stock	3670-0665	\$69.08
Black	1 1/4	31.8	1.97	50.0	5000	344.7	—	16.5	2.67	200	Ctn	T	Stock	3670-0670	97.80
Black	1 1/2	38.1	2.26	57.4	5000	344.7	—	20.0	3.33	200	Ctn	T	Stock	3670-0675	114.08
Black	2	50.8	2.80	71.1	5000	344.7	—	25.0	4.94	50	Ctn	T	Stock	3670-0679	148.50
Black	2	50.8	2.80	71.1	5000	344.7	—	25.0	4.94	200	Ctn	T	Stock	3670-0680	148.50

**RECOMMENDED FOR:** Rotary applications on work over rigs and slim hole or seismograph rigs designed to operate at a maximum of 1,500 to 5,000 PSI rated working pressure depending on size. Applications on small or medium-size drilling rigs used for water well operations, water well core drill, blast or shot hole operations. For normal mud applications on small to medium-sized rigs where flexible connections are needed for pressure lines conveying mud.

**TEMPERATURE:** -40°F to +180°F (-40°C to +82°C) continuous service.

**CONSTRUCTION:** **Tube:** Type C (Nitrile). Black.  
**Reinforcement:** High tensile steel wire.  
**Cover:** Type A (Chloroprene). Black with yellow stripe. All sizes are perforated.  
**Design Factor:** 2.5:1

**COUPLINGS:** 1 1/4" I.D. 5,000 psi. Gates 20GS-20MPAPI (7347-76955)  
 1" I.D. 5,000 psi. Gates 16GS-16MPLH (7347-76545)  
 2 1/2", 3" and 4" - Swaged-On Permanent Couplings - API threads on connecting end of stem for easy flange attachment. Strong collar to anchor ferrule to stem. Electroplated steel. Also available in stainless steel and other special metals. Wildman Type Q reusable couplings.  
 4" - Use George Myer Stem and Ferrule.  
 71 Permanent (Mulconroy - API threads only) or reusable male couplings (Wildman - API threads only). 77 Gates GSM with Integral 2" Fig. 1502 Hammer Unions or 80 Gates GSP (1 1/2" or 2" only). Reference the Hose Coupling Section. For GS couplings reference Gates Hydraulic Hose catalog #35093.  
 Sources: Dixon Valve and Coupling Co., George Myer Co, Inc.

**STANDARDS:** **Tube:** ARPM (Class A) High oil-resistance.  
**Cover:** Meets MSHA Flame-resistant.

AGRICULTURE

AIR BREATHING

AIR DUCT

AIR AND MULTI-PURPOSE

CHEMICAL

FOOD AND BEVERAGE

MARINE AND ENGINE

MATERIAL HANDLING

MINING

OILFIELD

PETROLEUM

PRESSURE WASH AND WASHDOWN

STEAM

WATER

CLAMPS

COUPLINGS AND FERRULES

HOSE FINDER

CHEMICAL RESISTANCE TABLE



## Black Gold® ABS Potable Water 300SD



AGRICULTURE
AIR BREATHING
AIR DUCT
AIR AND MULTI-PURPOSE
CHEMICAL
FOOD AND BEVERAGE
MARINE AND ENGINE
MATERIAL HANDLING
MINING
OILFIELD
PETROLEUM
PRESSURE WASH AND WASHDOWN
STEAM
WATER
CLAMPS
COUPLINGS AND FERRULES
HOSE FINDER
CHEMICAL RESISTANCE TABLE

Color	Hose I.D.		Hose O.D.		Max. W.P.		Vac.	MBR	Wt. Per ft	Length	Std. Pack	Pkg Code	Stock or MTO (ft)	Gates Item No.	List Price Per ft
	(in)	(mm)	(in)	(mm)	(psi)	(Bar)									
Orange	4	101.6	4.96	126.0	300	20.7	29.0	28.0	3.68	200	PLT	T	Stock	3132-5013	\$81.01
Orange	5	127.0	6.09	154.7	300	20.7	29.0	36.0	5.05	100	PLT	T	Stock	3132-5032	114.09
Orange	6	152.4	7.16	181.9	300	20.7	29.0	40.0	6.69	100	PLT	T	Stock	3132-5033	146.88

**RECOMMENDED FOR:** Transfer of potable water, non-potable water or liquids not containing oils or chemicals from a supply ship to an offshore drilling rig or platform. Various water-based transfer applications for offshore or onshore work sites. The food-grade tube meets FDA requirements and will not impart taste to drinking water. The heavy-duty reinforcement is designed to survive extreme oilfield application requirements. The specially compounded cover material is designed to withstand the harshest environment including abrasion and weathering.

**CAUTION:** Do not alternate between potable water and non-potable liquid transfer to avoid cross-contamination of drinking water or food products.

**TEMPERATURE:** -40°F to +150°F (-40°C to +66°C).

**CONSTRUCTION:**  
**Tube:** Type D2 (Natural Rubber). White.  
**Reinforcement:** Synthetic, high tensile textile with steel wire helix.  
**Cover:** Type P (EPDM). Orange with blue stripe.  
**Design Factor:** 4:1

**COUPLINGS:** Crimped or swaged couplings. 71. Reference the Hose Coupling Section.

**STANDARDS:** ABS approved.  
 Food-grade tube meets FDA requirements. Hose designed to withstand 2.5 ton tensile force.

**Black Gold® ABS Potable Water 300D**



Color	Hose I.D.		Hose O.D.		Max. W.P.		Vac.	MBR	Wt. Per ft	Length	Std. Pack	Pkg Code	Stock or MTO	Gates Item No.	List Price Per ft
	(in)	(mm)	(in)	(mm)	(psi)	(Bar)									
Orange	2	50.8	2.69	68.3	300	20.7	—	—	1.27	200	PLT	T	Stock	3132-5010	\$31.21
Orange	3	76.2	3.74	95.0	300	20.7	—	—	1.82	200	PLT	T	Stock	3132-5011	62.05
Orange	4	101.6	4.69	119.1	300	20.7	—	—	1.75	200	PLT	T	Stock	3132-5012	89.03

**RECOMMENDED FOR:** Transfer of potable water, non-potable water or liquids not containing oils or chemicals from a supply ship to an offshore drilling rig or platform. Various water-based transfer applications for offshore or onshore work sites. The food-grade tube meets FDA requirements and will not impart taste to drinking water. The heavy-duty reinforcement is designed to survive extreme oilfield application requirements. The specially compounded cover material is designed to withstand the harshest environment including abrasion and weathering.

**CAUTION:** Do not alternate between potable water and non-potable liquid transfer to avoid cross-contamination of drinking water or food products.

**TEMPERATURE:** -40°F to +150°F (-40°C to +66°C).

**CONSTRUCTION:**  
**Tube:** Type D2 (Natural Rubber). White.  
**Reinforcement:** Synthetic, high tensile textile.  
**Cover:** Type P (EPDM). Orange with blue stripe.  
**Design Factor:** 4:1

**COUPLINGS:** Crimped or swaged couplings. 71. Reference the Hose Coupling Section.

**STANDARDS:** ABS approved.  
 Food-grade tube meets FDA requirements. Hose designed to withstand 2.5 ton tensile force.

AGRICULTURE
AIR BREATHING
AIR DUCT
AIR AND MULTI-PURPOSE
CHEMICAL
FOOD AND BEVERAGE
MARINE AND ENGINE
MATERIAL HANDLING
MINING
OILFIELD
PETROLEUM
PRESSURE WASH AND WASHDOWN
STEAM
WATER
CLAMPS
COUPLINGS AND FERRULES
HOSE FINDER
CHEMICAL RESISTANCE TABLE

**Black Gold® Potable Water (150-300) D**  
Formerly - Aquarius®



AGRICULTURE
AIR BREATHING
AIR DUCT
AIR AND MULTI-PURPOSE
CHEMICAL
FOOD AND BEVERAGE
MARINE AND ENGINE
MATERIAL HANDLING
MINING
OILFIELD
PETROLEUM
PRESSURE WASH AND WASHDOWN
STEAM
WATER
CLAMPS
COUPLINGS AND FERRULES
HOSE FINDER
CHEMICAL RESISTANCE TABLE

Color	Hose I.D.	Hose O.D.	Max. W.P.	Vac.	MBR	Wt. Per ft	Length	Std. Pack	Pkg Code	Stock or MTO	Gates Item No.	List Price Per ft				
	(in)	(mm)											(in)	(mm)	(psi)	(Bar)
Tan	1	25.4	1.53	38.9	300	20.7	15.0	10.0	10.0	.56	200	PLT	T	MTO	3132-0803	\$14.79
Tan	2	50.8	2.70	68.6	300	20.7	10.0	14.0	14.0	1.49	200	PLT	T	MTO	3132-0815	28.80
Tan	3	76.2	3.70	94.0	200	13.8	10.0	21.0	21.0	2.15	200	PLT	T	MTO	3132-0823	39.80
Tan	4	101.6	4.70	119.4	150	10.3	10.0	28.0	28.0	2.74	200	PLT	T	MTO	3132-0832	49.10

**RECOMMENDED FOR:** Transfer of potable water, non-potable water or liquids not containing oils or chemicals and applications which require a lightweight, flexible hose with a tight bend radius and a high rated working pressure in long continuous lengths.

**TEMPERATURE:** -40°F to +150°F (-40°C to +66°C) continuous service.

**CONSTRUCTION:**  
**Tube:** Type D2 (Natural Rubber food-grade). White.  
**Reinforcement:** Multiple plies of synthetic cord.  
**Cover:** Type P (EPDM). Tan with blue stripe. Abrasion and weather resistant.  
**Design Factor:** 4:1

**COUPLINGS:** 14, 15, 71 or 8. Reference the Hose Coupling Section.

**STANDARDS:** Tube meets FDA requirements.

Black Gold® ABS Bulk Material 300SD



Color	Hose I.D.		Hose O.D.		Max. W.P.		Vac.	MBR	Wt. Per ft	Length	Std. Pack	Pkg Code	Stock or MTO	Gates Item No.	List Price Per ft
	(in)	(mm)	(in)	(mm)	(psi)	(Bar)	(In. Hg)	(in)	(Lbs.)	(ft)			(ft)		
Black	3	76.2	4.23	107.4	300	20.7	29.0	32.0	3.47	200	PLT	T	Stock	4691-0017	\$53.41
Black	4	101.6	5.30	134.6	300	20.7	29.0	42.0	4.71	200	PLT	T	Stock	4691-0018	67.39
Black	5	127.0	6.33	160.8	300	20.7	29.0	51.0	6.02	100	PLT	T	Stock	4691-0039	83.16
Black	6	152.4	7.33	186.2	300	20.7	29.0	60.0	6.02	100	PLT	T	Stock	4691-0040	99.17

**RECOMMENDED FOR:** Transfer of abrasive materials such as barite and cement from a supply ship to an offshore drilling rig or platform; and for transfer applications on offshore or onshore drilling rigs or platforms. The heavy-duty reinforcement is designed to survive extreme oilfield application requirements. The specially compounded cover material is designed to withstand the harshest environment including abrasion and weathering.

**CAUTION:** The hose tube is specially compounded to conduct electricity. No static wires are required. (The helical wires in the SD version can be connected to the couplings for extra protection.)

**TEMPERATURE:** -40°F to +150°F (-40°C to +66°C).

**CONSTRUCTION:**  
**Tube:** Type D3 (Natural Rubber). Black. Static-conductive.  
**Reinforcement:** Synthetic, high tensile textile with steel wire helix.  
**Cover:** Type D (SBR). Black with yellow stripe.  
**Design Factor:** 4:1

**COUPLINGS:** Crimped or swaged couplings. 71. Reference the Hose Coupling Section.

**STANDARDS:** ABS approved.  
 Hose designed to withstand 6.0 ton tensile force.

AGRICULTURE

AIR BREATHING

AIR DUCT

AIR AND MULTI-PURPOSE

CHEMICAL

FOOD AND BEVERAGE

MARINE AND ENGINE

MATERIAL HANDLING

MINING

OILFIELD

PETROLEUM

PRESSURE WASH AND WASHDOWN

STEAM

WATER

CLAMPS

COUPLINGS AND FERRULES

HOSE FINDER

CHEMICAL RESISTANCE TABLE

## Black Gold® ABS Bulk Material (250-300) D



AGRICULTURE
AIR BREATHING
AIR DUCT
AIR AND MULTI-PURPOSE
CHEMICAL
FOOD AND BEVERAGE
MARINE AND ENGINE
MATERIAL HANDLING
MINING
OILFIELD
PETROLEUM
PRESSURE WASH AND WASHDOWN
STEAM
WATER
CLAMPS
COUPLINGS AND FERRULES
HOSE FINDER
CHEMICAL RESISTANCE TABLE

Color	Hose I.D.	Hose O.D.	Max. W.P.	Vac.	MBR	Wt. Per ft	Length	Std. Pack	Pkg Code	Stock or MTO	Gates Item No.	List Price Per ft			
	(in)	(mm)											(in)	(mm)	(psi)
Black	3	76.2	3.98	101.1	300	20.7	10.0	21.0	2.64	200	PLT	T	Stock	3129-1000	\$39.83
Black	4	101.6	4.96	126.0	300	20.7	10.0	28.0	3.40	200	PLT	T	Stock	3129-1001	47.28
Black	5	127.0	6.14	156.0	300	20.7	10.0	35.0	4.67	100	PLT	T	Stock	3129-1013	70.17
Black	6	152.4	7.13	181.1	250	17.2	10.0	42.0	5.51	100	PLT	T	Stock	3129-1014	69.96

**RECOMMENDED FOR:** Transfer of abrasive materials such as barite and cement from a supply ship to an offshore drilling rig or platform; and for transfer applications on offshore or onshore drilling rigs or platforms. The heavy-duty reinforcement is designed to survive extreme oilfield application requirements. The specially compounded cover material is designed to withstand the harshest environment including abrasion and weathering.

**CAUTION:** The hose tube is specially compounded to conduct electricity. No static wires are required. (The helical wires in the SD version can be connected to the couplings for extra protection.)

**TEMPERATURE:** -40°F to +150°F (-40°C to +66°C).

**CONSTRUCTION:**  
**Tube:** Type D3 (Natural Rubber). Black. Static-conductive.  
**Reinforcement:** Synthetic, high tensile textile.  
**Cover:** Type D (SBR). Black with yellow stripe.  
**Design Factor:** 4:1

**COUPLINGS:** Crimped or swaged couplings. 71. Reference the Hose Coupling Section.

**STANDARDS:** ABS approved.  
 Hose designed to withstand 6.0 ton tensile force.

# Black Gold® Blender Transfer 150D



Color	Hose I.D.	Hose O.D.	Max. W.P.	Vac.	MBR	Wt. Per ft	Length	Std. Pack	Pkg Code	Stock or MTO (ft)	Gates Item No.	List Price Per ft
	(in)	(mm)	(psi)	(in. Hg)	(in)	(Lbs.)	(ft)					
Black	4	4.73	150	—	—	3.07	100	PLT	T	Stock	4110-0400	\$65.63
Black	5	5.73	150	—	—	3.77	100	PLT	T	MTO	4110-0500	80.58

**RECOMMENDED FOR:** Transfer of water, petroleum-based fluids, dilute acids, chemicals and abrasive slurries used in oil and gas well stimulation and fracking.

**TEMPERATURE:** -40°F to +180°F (-40°C to +82°C).

**CONSTRUCTION:**  
**Tube:** Type C (Nitrile). Black.  
**Reinforcement:** Synthetic, high tensile textile.  
**Cover:** Type A (Chloroprene). Black with red stripe.  
**Design Factor:** 4:1

**STANDARDS:** **Tube:** ARPM (Class A) High oil-resistance.

AGRICULTURE

AIR BREATHING

AIR DUCT

AIR AND MULTI-PURPOSE

CHEMICAL

FOOD AND BEVERAGE

MARINE AND ENGINE

MATERIAL HANDLING

MINING

OILFIELD

PETROLEUM

PRESSURE WASH AND WASHDOWN

STEAM

WATER

CLAMPS

COUPLINGS AND FERRULES

HOSE FINDER

CHEMICAL RESISTANCE TABLE

## Black Gold® Super-Vac® (60-150) SD



### Smooth Cover

Color	Hose I.D.		Hose O.D.		Max. W.P.		Vac.	MBR	Wt. Per ft	Length	Std. Pack	Pkg Code	Stock or MTO (ft)	Gates Item No.	List Price Per ft
	(in)	(mm)	(in)	(mm)	(psi)	(Bar)									
Black	1 3/4	44.5	2.12	53.8	150	10.3	30.0	4.0	.84	100	PLT	T	MTO	4688-0660	\$15.93
Black	2	50.8	2.47	62.7	150	10.3	30.0	4.0	1.00	100	PLT	T	MTO	4688-1496	18.54
Black	3	76.2	3.52	89.4	150	10.3	30.0	6.0	1.77	100	PLT	T	MTO	4688-1497	27.37
Black	4	101.6	4.52	114.8	100	6.9	30.0	8.0	2.29	100	PLT	T	MTO	4688-1498	36.63

### Corrugated Cover

Color	Hose I.D.		Hose O.D.		Max. W.P.		Vac.	MBR	Wt. Per ft	Length	Std. Pack	Pkg Code	Stock or MTO (ft)	Gates Item No.	List Price Per ft
	(in)	(mm)	(in)	(mm)	(psi)	(Bar)									
Black	1	25.4	1.42	36.1	150	10.3	30.0	3.0	.52	100	PLT	T	Stock	4688-0651	\$13.06
Black	1 1/4	31.8	1.68	42.7	150	10.3	30.0	3.0	.67	100	PLT	T	Stock	4688-0653	13.85
Black	1 1/2	38.1	1.97	50.0	150	10.3	30.0	3.0	.77	100	PLT	T	Stock	4688-0656	15.06
Black	2	50.8	2.47	62.7	150	10.3	30.0	4.0	.99	100	PLT	T	Stock	4688-0665	18.54
Black	2	50.8	2.47	62.7	150	10.3	30.0	4.0	.94	200	PLT	T	MTO	4688-0668	18.54
Black	2 1/2	63.5	2.99	75.9	150	10.3	30.0	5.0	1.52	100	PLT	T	Stock	4688-0675	24.00
Black	3	76.2	3.52	89.4	150	10.3	30.0	6.0	1.89	100	PLT	T	Stock	4688-0680	27.37
Black	4	101.6	4.52	114.8	100	6.9	30.0	8.0	2.47	100	PLT	T	Stock	4688-0690	36.63
Black	4	101.6	4.52	114.8	100	6.9	30.0	8.0	2.29	200	PLT	T	MTO	4688-2178	40.29
Black	6	152.4	6.67	169.4	60	4.1	30.0	18.0	4.56	20	PLT	T	Stock	4688-0697	61.03
Black	6	152.4	6.67	169.4	60	4.1	30.0	18.0	4.56	50	PLT	T	Stock	4688-0698	61.03
Black	6	152.4	6.67	169.4	60	4.1	30.0	18.0	4.29	100	PLT	T	MTO	4688-1613	61.03
Black	6	152.4	6.67	169.4	60	4.1	30.0	18.0	4.56	200	PLT	T	MTO	4688-0702	61.03

**RECOMMENDED FOR:** Tank truck service, including oilfield vacuum truck, where full suction or rated working pressures are required. Ideal for applications handling crude oil, salt and fresh water, tank bottoms, drilling mud, dilute solutions of hydrochloric acids, diesel fuels and sewage transfer. Reference Gates Chemical Resistance Table.

**CAUTION:** Not recommended for refined petroleum products such as gasoline or diesel. Drain hose after use.

**TEMPERATURE:** -40°F to +180°F (-29°C to +82°C) continuous service.

**CONSTRUCTION:**  
**Tube:** Type C (Nitrile). Black.  
**Reinforcement:** Synthetic, high tensile textile with steel wire helix.  
**Cover:** Type D (SBR). Black corrugated with blue stripe.  
**Design Factor:** 4:1

**COUPLINGS:** 6, 7 or 78. (for ambient temperatures only). Reference the Hose Coupling Section.

**STANDARDS:** **Tube:** ARPM (Class B) Medium oil-resistance.

AGRICULTURE
AIR BREATHING
AIR DUCT
AIR AND MULTI-PURPOSE
CHEMICAL
FOOD AND BEVERAGE
MARINE AND ENGINE
MATERIAL HANDLING
MINING
OILFIELD
PETROLEUM
PRESSURE WASH AND WASHDOWN
STEAM
WATER
CLAMPS
COUPLINGS AND FERRULES
HOSE FINDER
CHEMICAL RESISTANCE TABLE

## Black Gold® Oilfield Vacuum (100-150) SD



Color	Hose I.D.		Hose O.D.		Max. W.P.		Vac.	MBR	Wt. Per ft	Length	Std. Pack	Pkg Code	Stock or MTO (ft)	Gates Item No.	List Price Per ft
	(in)	(mm)	(in)	(mm)	(psi)	(Bar)									
Black	2	50.8	2.47	62.7	150	10.3	30.0	4.0	1.05	100	PLT	T	Stock	4688-1761	\$17.05
Black	3	76.2	3.50	88.9	150	10.3	30.0	6.0	2.17	100	PLT	T	Stock	4688-1762	25.18
Black	4	101.6	4.52	114.8	100	6.9	30.0	8.0	2.14	100	PLT	T	Stock	4688-1763	33.70

**RECOMMENDED FOR:** An economical, lightweight hose designed for oilfield waste pit recovery, tank truck service, including oilfield vacuum truck, where full suction or rated working pressures are required. Ideal for applications handling crude oil, salt and fresh water, tank bottoms, drilling mud, dilute solutions of hydrochloric acids and sewage transfer. Reference Gates Chemical Resistance Table.

**CAUTION:** Not recommended for refined petroleum products such as gasoline or diesel. Drain hose after use.

**TEMPERATURE:** -40°F to +150°F (-40°C to +66°C) continuous service. NOTE: Diesel fuel normally conveyed below +120°F (+49°C).

**CONSTRUCTION:**  
**Tube:** Type C (Nitrile). Black.  
**Reinforcement:** Synthetic, high tensile textile cord with steel wire helix.  
**Cover:** Type D (SBR). Black corrugated with blue stripe.  
**Design Factor:** 3:1

**COUPLINGS:** 6, 7 or 78. (for ambient temperatures only). Reference the Hose Coupling Section.

**STANDARDS:** **Tube:** ARPM (Class B) Medium oil-resistance.

AGRICULTURE

AIR BREATHING

AIR DUCT

AIR AND MULTI-PURPOSE

CHEMICAL

FOOD AND BEVERAGE

MARINE AND ENGINE

MATERIAL HANDLING

MINING

OILFIELD

PETROLEUM

PRESSURE WASH AND WASHDOWN

STEAM

WATER

CLAMPS

COUPLINGS AND FERRULES

HOSE FINDER

CHEMICAL RESISTANCE TABLE



## Black Gold® Super-Vac® MegaFlex® (100-200) SD



AGRICULTURE
AIR BREATHING
AIR DUCT
AIR AND MULTI-PURPOSE
CHEMICAL
FOOD AND BEVERAGE
MARINE AND ENGINE
MATERIAL HANDLING
MINING
OILFIELD
PETROLEUM
PRESSURE WASH AND WASHDOWN
STEAM
WATER
CLAMPS
COUPLINGS AND FERRULES
HOSE FINDER
CHEMICAL RESISTANCE TABLE

Color	Hose I.D.		Hose O.D.		Max. W.P.		Vac.	MBR	Wt. Per ft	Length	Std. Pack	Pkg Code	Stock or MTO	Gates Item No.	List Price Per ft
	(in)	(mm)	(in)	(mm)	(psi)	(Bar)									
Black	2	50.8	2.39	60.7	150	10.3	30.0	2.0	.80	100	PLT	T	Stock	4688-2104	\$20.39
Black	2	50.8	2.39	60.7	150	10.3	30.0	2.0	1.00	200	PLT	T	MTO	4688-2105	20.39
Black	3	76.2	3.47	88.1	150	10.3	30.0	3.0	1.33	100	PLT	T	Stock	4688-2107	30.11
Black	3	76.2	3.47	88.1	150	10.3	30.0	3.0	1.77	200	PLT	T	MTO	4688-2164	21.68
Black	4	101.6	4.52	114.8	100	6.9	30.0	4.0	2.29	100	PLT	T	Stock	4688-2108	40.29
Black	4	101.6	4.52	114.8	200	13.8	30.0	4.0	2.12	100	PLT	T	Stock	4688-2109	44.32
Black	4	101.6	4.52	114.8	200	13.8	30.0	4.0	2.29	200	PLT	T	MTO	4688-2165	32.89

**RECOMMENDED FOR:** Tank truck service, including oilfield vacuum tank, where full suction is required. Ideal for applications handling crude oil, salt and fresh water, tank bottoms, drilling mud, dilute solutions of hydrochloric acid, diesel fuels, and sewage transfer.

**CAUTION:** Not recommended for refined petroleum products such as gasoline or diesel. Drain hose after use.

**TEMPERATURE:** -40°F to +180°F (-40°C to +82°C) continuous service.

**CONSTRUCTION:**  
**Tube:** Type C (Nitrile). Black.  
**Reinforcement:** Synthetic, high tensile textile with dual steel wire helix.  
**Cover:** Type D (SBR). Black corrugated with blue stripe.  
**Design Factor:** 4:1

**COUPLINGS:** 7, 49 or 73. (for ambient temperatures only). Reference the Hose Coupling Section.

**STANDARDS:** **Tube:** ARPM (Class B) Medium oil-resistance.

**Black Gold® ABS Mud and Oil 300SD**



Color	Hose I.D.	Hose O.D.	Max. W.P.	Vac.	MBR	Wt. Per ft	Length	Std. Pack	Pkg Code	Stock or MTO	Gates Item No.	List Price Per ft			
	(in)	(mm)											(in)	(mm)	(psi)
Black	2	50.8	2.87	72.9	300	20.7	30.0	24.0	1.88	200	PLT	T	Stock	4689-0001	\$29.57
Black	3	76.2	3.85	97.8	300	20.7	30.0	32.0	2.83	200	PLT	T	Stock	4689-0005	41.01
Black	4	101.6	5.10	129.5	300	20.7	30.0	42.0	4.48	200	PLT	T	Stock	4689-0002	57.28
Black	5	127.0	6.20	157.5	300	20.7	30.0	51.0	6.00	100	PLT	T	Stock	4689-0006	78.69
Black	6	152.4	7.40	188.0	300	20.7	30.0	60.0	8.59	100	PLT	T	Stock	4689-0007	99.95

**RECOMMENDED FOR:** Transfer of abrasive, water-based and petroleum-based drilling fluids from a supply ship to an offshore drilling rig or platform; and for transfer applications on offshore or onshore drilling rigs or platforms. The nitrile tube material is designed to provide chemical resistance to petroleum-based fluids and is made with extra thickness to resist abrasion. It uses the same tube compound as Gates Black Gold® Grade D & E Rotary & Vibrator hoses. The heavy-duty reinforcement is designed to survive extreme oilfield application requirements. The neoprene cover material is designed to withstand the harshest offshore environment including abrasion, weathering (cracks) and extra chemical-resistance for any petroleum products that may come in contact with the cover.

**CAUTION:** Not recommended for transferring refined petroleum products such as gasoline.

**TEMPERATURE:** -40°F to +180°F (-40°C to +82°C).

**CONSTRUCTION:** **Tube:** Type C (Nitrile). Black.  
**Reinforcement:** Synthetic, high tensile textile with steel wire helix.  
**Cover:** Type A (Chloroprene). Black with white stripe.  
**Design Factor:** 4:1

**COUPLINGS:** Crimped or swaged couplings. 71. Reference the Hose Coupling Section.

**STANDARDS:** ABS approved.  
 ARPM (Class A) High oil-resistance.

AGRICULTURE

AIR BREATHING

AIR DUCT

AIR AND MULTI-PURPOSE

CHEMICAL

FOOD AND BEVERAGE

MARINE AND ENGINE

MATERIAL HANDLING

MINING

OILFIELD

PETROLEUM

PRESSURE WASH AND WASHDOWN

STEAM

WATER

CLAMPS

COUPLINGS AND FERRULES

HOSE FINDER

CHEMICAL RESISTANCE TABLE

## Black Gold® ABS Mud and Oil 300D



AGRICULTURE
AIR BREATHING
AIR DUCT
AIR AND MULTI-PURPOSE
CHEMICAL
FOOD AND BEVERAGE
MARINE AND ENGINE
MATERIAL HANDLING
MINING
OILFIELD
PETROLEUM
PRESSURE WASH AND WASHDOWN
STEAM
WATER
CLAMPS
COUPLINGS AND FERRULES
HOSE FINDER
CHEMICAL RESISTANCE TABLE

Color	Hose I.D.	Hose O.D.	Max. W.P.	Vac.	MBR	Wt. Per ft	Length	Std. Pack	Pkg Code	Stock or MTO	Gates Item No.	List Price Per ft			
	(in)	(mm)											(in)	(mm)	(psi)
Black	2	50.8	2.62	66.5	300	20.7	10.0	14.0	1.12	200	PLT	T	Stock	3150-0503	\$24.93
Black	3	76.2	3.62	91.9	300	20.7	10.0	21.0	1.94	200	PLT	T	Stock	3150-0504	34.79
Black	4	101.6	4.62	117.3	300	20.7	10.0	28.0	2.39	200	PLT	T	Stock	3150-0505	41.62
Black	5	127.0	5.92	150.4	300	20.7	10.0	35.0	4.40	100	PLT	T	Stock	3150-0509	66.34
Black	6	152.4	6.92	175.8	300	20.7	10.0	42.0	5.25	100	PLT	T	Stock	3150-0508	82.06

**RECOMMENDED FOR:** Transfer of abrasive, water-based and petroleum-based drilling fluids from a supply ship to an offshore drilling rig or platform; and for transfer applications on offshore or onshore drilling rigs or platforms. The nitrile tube material is designed to provide chemical resistance to petroleum-based fluids and is made with extra thickness to resist abrasion. It uses the same tube compound as Gates Black Gold® Grade D & E Rotary & Vibrator hoses. The heavy-duty reinforcement is designed to survive extreme oilfield application requirements. The neoprene cover material is designed to withstand the harshest offshore environment including abrasion, weathering (cracks) and extra chemical-resistance for any petroleum products that may come in contact with the cover.

**CAUTION:** Not recommended for transferring refined petroleum products such as gasoline.

**TEMPERATURE:** -40°F to +180°F (-40°C to +82°C).

**CONSTRUCTION:**  
**Tube:** Type C (Nitrile). Black.  
**Reinforcement:** Synthetic, high tensile textile.  
**Cover:** Type A (Chloroprene). Black with white stripe.  
**Design Factor:** 4:1

**COUPLINGS:** Crimped or swaged couplings. 71. Reference the Hose Coupling Section.

**STANDARDS:** ABS approved.  
ARPM (Class A) High oil-resistance.

**Black Gold® Fuel 300SD**  
Formerly - Sea Horse® HW



Color	Hose I.D.	Hose O.D.	Max. W.P.	Vac.	MBR	Wt. Per ft	Length	Std. Pack	Pkg Code	Stock or MTO	Gates Item No.	List Price Per ft			
	(in)	(mm)											(in)	(mm)	(psi)
Black	2	50.8	2.78	70.6	300	20.7	30.0	10.0	1.60	200	PLT	T	Stock	4688-0584	\$47.98
Black	3	76.2	3.86	98.0	300	20.7	30.0	18.0	2.59	200	PLT	T	Stock	4688-0585	67.30
Black	4	101.6	4.87	123.7	300	20.7	30.0	24.0	3.52	200	PLT	T	Stock	4688-0587	79.06
Black	6	152.4	7.07	179.6	300	20.7	30.0	36.0	5.00	100	PLT	T	Stock	4688-0589	168.00
Black	6	152.4	7.07	179.6	300	20.7	30.0	36.0	6.67	200	PLT	T	MTO	4688-0588	168.00

**RECOMMENDED FOR:** Transfer of refined fuels (commercial gasoline and diesel fuel) oils and other petroleum products. Ideal for offshore/onshore transfer applications involving suction and discharge service for diesel oils and other similar petroleum products where an extremely lightweight, hardwall, flexible hose with a high rated working pressure and a small minimum bend radius is required. Transfer of water, petroleum-based fluids, dilute acids, chemicals and abrasive slurries used in oil and gas well stimulation and fracking.

**CAUTION:** For Bio-Diesel and other alternative fuel applications, see Fuel Master™ XTreme™. Petroleum transfer hoses may be used with all grades of Bio-Diesel only if the exposure is intermittent and the hose is drained between uses. Transfer hoses are designed for intermittent contact with refined fuels and must be drained after use. Do not convey fuels over +120°F (+49°C).

**TEMPERATURE:** -40°F to +180°F (-40°C to +82°C) continuous service.

**CONSTRUCTION:**  
**Tube:** Type C (Nitrile). Black.  
**Reinforcement:** Synthetic, high tensile textile with steel wire helix.  
**Cover:** Type A (Chloroprene). Black with brown stripe.  
**Design Factor:** 4:1

**COUPLINGS:** 14, 15 or 71. Reference the Hose Coupling Section.

**STANDARDS:** **Tube:** ARPM (Class A) High oil-resistance.

AGRICULTURE

AIR BREATHING

AIR DUCT

AIR AND MULTI-PURPOSE

CHEMICAL

FOOD AND BEVERAGE

MARINE AND ENGINE

MATERIAL HANDLING

MINING

OILFIELD

PETROLEUM

PRESSURE WASH AND WASHDOWN

STEAM

WATER

CLAMPS

COUPLINGS AND FERRULES

HOSE FINDER

CHEMICAL RESISTANCE TABLE

**Black Gold® Fuel 300D**  
Formerly - Sea Horse®



AGRICULTURE
AIR BREATHING
AIR DUCT
AIR AND MULTI-PURPOSE
CHEMICAL
FOOD AND BEVERAGE
MARINE AND ENGINE
MATERIAL HANDLING
MINING
OILFIELD
PETROLEUM
PRESSURE WASH AND WASHDOWN
STEAM
WATER
CLAMPS
COUPLINGS AND FERRULES
HOSE FINDER
CHEMICAL RESISTANCE TABLE

Color	Hose I.D.	Hose O.D.	Max. W.P.	Vac.	MBR	Wt. Per ft	Length	Std. Pack	Pkg Code	Stock or MTO	Gates Item No.	List Price Per ft			
	(in)	(mm)											(in)	(mm)	(psi)
Black	2	50.8	2.66	67.6	300	20.7	10.0	14.0	1.78	200	PLT	T	Stock	4110-0701	\$37.40
Black	2 1/2	63.5	3.16	80.3	300	20.7	10.0	17.0	2.16	200	PLT	T	MTO	4110-0704	46.43
Black	3	76.2	3.70	94.0	300	20.7	10.0	21.0	2.45	200	PLT	T	Stock	4110-0707	53.03
Black	4	101.6	4.70	119.4	300	20.7	10.0	28.0	3.14	200	PLT	T	Stock	4110-0710	65.69
Black	5	127.0	6.84	173.7	300	20.7	10.0	35.0	4.50	200	PLT	T	Stock	4110-0713	97.44
Black	6	152.4	6.84	173.7	300	20.7	10.0	46.0	4.91	100	PLT	T	Stock	4110-0017	76.54
Black	6	152.4	6.84	173.7	300	20.7	10.0	46.0	4.91	200	PLT	T	MTO	4110-0016	76.54

**RECOMMENDED FOR:** Transfer of refined fuels (commercial gasoline, diesel fuel) oils and other petroleum products. Ideal for offshore/onshore transfer applications involving discharge service for diesel oils and other similar petroleum products where an extremely lightweight, flexible hose with a high rated working pressure and a small minimum bend radius is required. Transfer of water, petroleum-based fluids, dilute acids, chemicals and abrasive slurries used in oil and gas well stimulation and fracking.

**CAUTION:** For Bio-Diesel and other alternative fuel applications, see Fuel Master™ XTreme™. Petroleum transfer hoses may be used with all grades of Bio-Diesel only if the exposure is intermittent and the hose is drained between uses. Transfer hoses are designed for intermittent contact with refined fuels and must be drained after use. Do not convey fuels over +120°F (+49°C).

**TEMPERATURE:** -40°F to +180°F (-40°C to +82°C) continuous service.

**CONSTRUCTION:**  
**Tube:** Type C (Nitrile). Black.  
**Reinforcement:** Synthetic, high tensile textile with static wire.  
**Cover:** Type A (Chloroprene). Black with brown stripe.  
**Design Factor:** 4:1

**COUPLINGS:** 14, 15, 71 all sizes. 26 2" and 2 1/2" only. Reference the Hose Coupling Section.

**STANDARDS:** **Tube:** ARPM (Class A) High oil-resistance.

**Black Gold® Oilfield Service 400D UltraBraid®**



Color	Hose I.D.		Hose O.D.		Max. W.P.		Vac.	MBR	Wt. Per ft	Length	Std. Pack	Pkg Code	Stock or MTO	Gates Item No.	List Price Per ft
	(in)	(mm)	(in)	(mm)	(psi)	(Bar)									
Black	3	76.2	3.65	92.7	400	27.6	10.0	22.0	1.95	100	PLT	T	Stock	4110-1109	\$63.95
Black	4	101.6	4.81	122.2	400	27.6	10.0	30.0	3.13	100	PLT	T	Stock	4110-1110	90.55

**RECOMMENDED FOR:** Transfer of water, petroleum-based fluids, dilute acids, chemicals and abrasive slurries used in oil and gas well stimulation and fracking. Transfer of refined fuels (commercial gasoline, diesel fuel) oils and other petroleum products. Transfer hoses are designed for intermittent contact with refined fuels and must be drained after use. Ideal for offshore/onshore dock hose transfer applications involving discharge service for diesel oils and other similar petroleum products where an extremely lightweight, flexible hose with a high rated working pressure and a small minimum bend radius is required. For Bio-Diesel and other alternative fuel applications, see Fuel Master™ XTreme™. Petroleum transfer hoses may be used with all grades of Bio-Diesel only if the exposure is intermittent and the hose is drained between uses.

**CAUTION:** Do not convey fuels over +120°F (+49°C).

**TEMPERATURE:** -40°F to +180°F (-40°C to +82°C) continuous service.

**CONSTRUCTION:** **Tube:** Type C (Nitrile), Black.  
**Reinforcement:** Synthetic, high tensile textile with static wire.  
**Cover:** Type C4 (Carboxylated Nitrile), Black with red stripe, Yellow Carboxylated Nitrile (Type C4) Wear Indicator Layer.  
**Design Factor:** 4:1

**COUPLINGS:** 71 (permanent crimp or swage). Reference the Hose Coupling Section.

**STANDARDS:** **Tube:** ARPM (Class A) High oil-resistance.

AGRICULTURE

AIR BREATHING

AIR DUCT

AIR AND MULTI-PURPOSE

CHEMICAL

FOOD AND BEVERAGE

MARINE AND ENGINE

MATERIAL HANDLING

MINING

OILFIELD

PETROLEUM

PRESSURE WASH AND WASHDOWN

STEAM

WATER

CLAMPS

COUPLINGS AND FERRULES

HOSE FINDER

CHEMICAL RESISTANCE TABLE

**Black Gold® Oilfield Service 400SD**



AGRICULTURE
AIR BREATHING
AIR DUCT
AIR AND MULTI-PURPOSE
CHEMICAL
FOOD AND BEVERAGE
MARINE AND ENGINE
MATERIAL HANDLING
MINING
OILFIELD
PETROLEUM
PRESSURE WASH AND WASHDOWN
STEAM
WATER
CLAMPS
COUPLINGS AND FERRULES
HOSE FINDER
CHEMICAL RESISTANCE TABLE

Color	Hose I.D.		Hose O.D.		Max. W.P.		Vac.	MBR	Wt. Per ft	Length	Std. Pack	Pkg Code	Stock or MTO	Gates Item No.	List Price Per ft
	(in)	(mm)	(in)	(mm)	(psi)	(Bar)									
Black	2	50.8	2.84	72.1	400	27.6	30.0	15.0	2.03	200	PLT	T	MTO	4688-0590	\$57.67
Black	3	76.2	4.00	101.6	400	27.6	30.0	20.0	3.66	200	PLT	T	Stock	4688-0591	73.97
Black	4	101.6	4.99	126.7	400	27.6	30.0	25.0	4.64	200	PLT	T	Stock	4688-0592	87.27

**RECOMMENDED FOR:** Transfer of water, petroleum-based fluids, dilute acids, chemicals and abrasive slurries used in oil and gas well stimulation and fracking. Transfer of refined fuels (commercial gasoline, diesel fuel) oils and other petroleum products. Transfer hoses are designed for intermittent contact with refined fuels and must be drained after use. Ideal for offshore/onshore dock hose transfer applications involving suction and discharge service for diesel oils and other similar petroleum products where an extremely light-weight, hardwall, flexible hose with a high rated working pressure and a small minimum bend radius is required. For Bio-Diesel and other alternative fuel applications, see Fuel Master™ XTreme™. Petroleum transfer hoses may be used with all grades of Bio-Diesel only if the exposure is intermittent and the hose is drained between uses.

**CAUTION:** Do not convey fuels over +120°F (+49°C).

**TEMPERATURE:** -40°F to +180°F (-40°C to +82°C) continuous service.

**CONSTRUCTION:** **Tube:** Type C (Nitrile). Black.  
**Reinforcement:** Synthetic, high tensile textile with steel wire helix.  
**Cover:** Type A (Chloroprene). Black with red stripe.  
**Design Factor:** 4:1

**COUPLINGS:** 14, 15 or 71. Reference the Hose Coupling Section.

**STANDARDS:** **Tube:** ARPM (Class A) High oil-resistance.

Black Gold® Oilfield Service 400D



Chloroprene Cover

Color	Hose I.D.		Hose O.D.		Max. W.P.		Vac.	MBR	Wt. Per ft	Length	Std. Pack	Pkg Code	Stock or MTO	Gates Item No.	List Price Per ft
	(in)	(mm)	(in)	(mm)	(psi)	(Bar)									
Black	2	50.8	2.70	68.6	400	27.6	10.0	17.0	1.51	200	PLT	T	MTO	4110-0715	\$41.60
Black	3	76.2	3.67	93.2	400	27.6	10.0	22.0	2.14	200	PLT	T	Stock	4110-0716	57.78
Black	4	101.6	4.83	122.7	400	27.6	10.0	30.0	3.43	200	PLT	T	Stock	4110-0717	72.33

MegaTuff® UHMWPE Cover (Abrasion-resistant)

Color	Hose I.D.		Hose O.D.		Max. W.P.		Vac.	MBR	Wt. Per ft	Length	Std. Pack	Pkg Code	Stock or MTO	Gates Item No.	List Price Per ft
	(in)	(mm)	(in)	(mm)	(psi)	(Bar)									
Black	3	76.2	3.67	93.2	400	27.6	10.0	22.0	1.51	100	PLT	T	Stock	4110-1107	\$63.56
Black	3	76.2	3.67	93.2	400	27.6	10.0	22.0	1.51	200	PLT	T	Stock	4110-1101	63.56
Black	4	101.6	4.84	122.9	400	27.6	10.0	30.0	3.17	100	PLT	T	MTO	4110-1108	79.56
Black	4	101.6	4.84	122.9	400	27.6	10.0	30.0	3.10	200	PLT	T	MTO	4110-1102	79.56

**RECOMMENDED FOR:** Transfer of water, petroleum-based fluids, dilute acids, chemicals and abrasive slurries used in oil and gas well stimulation and fracking. Transfer of refined fuels (commercial gasoline, diesel fuel) oils and other petroleum products. Transfer hoses are designed for intermittent contact with refined fuels and must be drained after use. Ideal for offshore/onshore dock hose transfer applications involving discharge service for diesel oils and other similar petroleum products where an extremely lightweight, flexible hose with a high rated working pressure and a small minimum bend radius is required. For Bio-Diesel and other alternative fuel applications, see Fuel Master™ XTreme™. Petroleum transfer hoses may be used with all grades of Bio-Diesel only if the exposure is intermittent and the hose is drained between uses.

**CAUTION:** Do not convey fuels over +120°F (+49°C).

**TEMPERATURE:** -40°F to +180°F (-40°C to +82°C) continuous service.

**CONSTRUCTION:** **Tube:** Type C (Nitrile). Black.  
**Reinforcement:** Synthetic, high tensile textile with static wire.  
**Cover:** Type A (Chloroprene). Black with red stripe.  
 Type L (Ultra High Molecular Weight Polyethylene) MegaTuff® UHMWPE.  
**Design Factor:** 4:1

**COUPLINGS:** 14, 15 or 71. Reference the Hose Coupling Section.

**STANDARDS:** **Tube:** ARPM (Class A) High oil-resistance.

AGRICULTURE

AIR BREATHING

AIR DUCT

AIR AND MULTI-PURPOSE

CHEMICAL

FOOD AND BEVERAGE

MARINE AND ENGINE

MATERIAL HANDLING

MINING

OILFIELD

PETROLEUM

PRESSURE WASH AND WASHDOWN

STEAM

WATER

CLAMPS

COUPLINGS AND FERRULES

HOSE FINDER

CHEMICAL RESISTANCE TABLE



## Black Gold® Oilfield Service (100-150) SD



AGRICULTURE
AIR BREATHING
AIR DUCT
AIR AND MULTI-PURPOSE
CHEMICAL
FOOD AND BEVERAGE
MARINE AND ENGINE
MATERIAL HANDLING
MINING
OILFIELD
PETROLEUM
PRESSURE WASH AND WASHDOWN
STEAM
WATER
CLAMPS
COUPLINGS AND FERRULES
HOSE FINDER
CHEMICAL RESISTANCE TABLE

Color	Hose I.D.		Hose O.D.		Max. W.P. (psi)	Max. W.P. (Bar)	Vac. (In. Hg)	MBR (in)	Wt. Per ea (Lbs.)	Length (ea)	Std. Pack	Pkg Code	Stock or MTO (ea)	Gates Item No.	List Price Per ea
	(in)	(mm)	(in)	(mm)											
Black	8	203.2	8.74	222.0	100	6.9	30.0	24.0	117.00	19	STRT	T	Stock	4688-2024	\$1,613.16
Black	8	203.2	8.74	222.0	100	6.9	30.0	24.0	217.00	20	STRT	T	Stock	4688-2025	1,688.37
Black	8	203.2	8.74	222.0	100	6.9	30.0	24.0	305.29	50	STRT	T	Stock	4688-2026	3,906.65
Black	8	203.2	9.00	228.6	150	10.3	30.0	24.0	165.73	20	STRT	T	Stock	4688-2048	2,200.26
Black	8	203.2	9.00	228.6	150	10.3	30.0	24.0	436.00	50	STRT	T	Stock	4688-2047	5,221.56

**RECOMMENDED FOR:** Heavy-duty suction and discharge applications handling crude oil, salt and fresh water, tank sediments, drilling mud and mild chemicals for oilfield applications such as frac tank connections.

**CAUTION:** Service life of transfer hoses can be extended by draining hoses after use.

**TEMPERATURE:** -40°F to +180°F (-40°C to +82°C) continuous service.

**CONSTRUCTION:**  
**Tube:** Type C (Nitrile). Black.  
**Reinforcement:** Synthetic, high tensile textile reinforcement with dual steel wire helix.  
**Cover:** Type D (SBR/Nitrile). Black with blue stripe.  
**Design Factor:** 3:1

**COUPLINGS:** 7, 21, 49 or 61. Reference the Hose Coupling Section.

**STANDARDS:**  
**Tube:** ARPM (Class A) High oil-resistance.  
**Cover:** ARPM (Class C) Limited oil-resistance.

# Black Gold® Oilfield Frac 400SD



Color	Hose I.D.		Hose O.D.		Max. W.P.		Vac.	MBR	Wt. Per ft	Length	Std. Pack	Pkg Code	Stock or MTO (ft)	Gates Item No.	List Price Per ft
	(in)	(mm)	(in)	(mm)	(psi)	(Bar)									
Black	4	101.6	4.78	121.4	400	27.6	30.0	38.0	3.92	100	PLT	T	Stock	4688-2222	\$48.26
Black	4	101.6	4.78	121.4	400	27.6	30.0	38.0	3.92	200	PLT	T	Stock	4688-2223	48.26

**RECOMMENDED FOR:** Heavy-duty, rugged hose that can serve applications such as transfer of hydraulic fracturing fluids, abrasive slurries and high pressure water applications in oil and gas well stimulation and fracking. Can handle waste water that has gas or petroleum impurities.

**TEMPERATURE:** -40°F to +180°F (-40°C to +82°C).

**CONSTRUCTION:**  
**Tube:** Type C (Nitrile). Black.  
**Reinforcement:** Synthetic, high tensile textile reinforcement with dual steel wire helix.  
**Cover:** Type D (SBR). Black with white stripe.  
**Design Factor:** 4:1

**COUPLINGS:** 71 (permanent crimp or swage) or 21 if pressure needed is 100 psi or below. Reference the Hose Coupling Section.

**STANDARDS:** Gates proprietary design.  
**Tube:** ARPM (Class A) Nitrile for high oil-resistance.  
**Cover:** SBR for abrasion-resistance.

AGRICULTURE

AIR BREATHING

AIR DUCT

AIR AND MULTI-PURPOSE

CHEMICAL

FOOD AND BEVERAGE

MARINE AND ENGINE

MATERIAL HANDLING

MINING

OILFIELD

PETROLEUM

PRESSURE WASH AND WASHDOWN

STEAM

WATER

CLAMPS

COUPLINGS AND FERRULES

HOSE FINDER

CHEMICAL RESISTANCE TABLE

## Black Gold® Oilfield Frac 400D



AGRICULTURE
AIR BREATHING
AIR DUCT
AIR AND MULTI-PURPOSE
CHEMICAL
FOOD AND BEVERAGE
MARINE AND ENGINE
MATERIAL HANDLING
MINING
OILFIELD
PETROLEUM
PRESSURE WASH AND WASHDOWN
STEAM
WATER
CLAMPS
COUPLINGS AND FERRULES
HOSE FINDER
CHEMICAL RESISTANCE TABLE

Color	Hose I.D.		Hose O.D.		Max. W.P.		Vac.	MBR	Wt. Per ft	Length	Std. Pack	Pkg Code	Stock or MTO	Gates Item No.	List Price Per ft
	(in)	(mm)	(in)	(mm)	(psi)	(Bar)									
Black	4	101.6	4.78	121.4	400	27.6	10.0	30.0	2.81	100	PLT	T	Stock	4110-0009	\$38.35
Black	4	101.6	4.78	121.4	400	27.6	10.0	30.0	2.81	200	PLT	T	MTO	4110-0010	38.35

**RECOMMENDED FOR:** Transfer of abrasive slurries used in oil and gas well stimulation and fracking, high-pressure water applications.

**TEMPERATURE:** -40°F to +180°F (-40°C to +82°C).

**CONSTRUCTION:**  
**Tube:** Type C (Nitrile). Black.  
**Reinforcement:** Synthetic, high tensile textile reinforcement.  
**Cover:** Type D (SBR). Black with white stripe.  
**Design Factor:** 4:1

**COUPLINGS:** 71 (permanent crimp or swage) or 21 if pressure needed is 100 psi or below. Reference the Hose Coupling Section.

**STANDARDS:** Gates proprietary design.  
**Tube:** ARPM (Class A) Nitrile for high oil-resistance.  
**Cover:** SBR for abrasion-resistance.

## Petroleum Hose

### Fuel Master™ XTreme™ 150SD Formerly - Longhorn® AF



#### Smooth Cover

Color	Hose I.D.	Hose O.D.	Max. W.P.	Vac.	MBR	Wt. Per ft	Length	Std. Pack	Pkg Code	Stock or MTO	Gates Item No.	List Price Per ft
	(in)											
Black	1	25.4	150	30.0	3.0	.59	100	PLT	T	Stock	4688-1700	\$19.09
Black	1	25.4	150	30.0	3.0	.59	200	PLT	T	MTO	4688-1701	19.09
Black	1 1/4	31.8	150	30.0	4.0	.70	100	PLT	T	MTO	4688-1702	20.89
Black	1 1/4	31.8	150	30.0	4.0	.70	200	PLT	T	MTO	4688-1703	20.89
Black	1 1/2	38.1	150	30.0	4.0	.87	100	PLT	T	Stock	4688-1704	22.91
Black	1 1/2	38.1	150	30.0	4.0	.87	200	PLT	T	MTO	4688-1705	22.91
Black	2	50.8	150	30.0	6.0	1.10	100	PLT	T	Stock	4688-1706	24.09
Black	2	50.8	150	30.0	6.0	1.10	200	PLT	T	MTO	4688-1707	24.09
Black	2 1/2	63.5	150	30.0	8.0	1.47	100	PLT	T	MTO	4688-1708	32.13
Black	2 1/2	63.5	150	30.0	8.0	1.47	200	PLT	T	MTO	4688-1709	32.13
Black	3	76.2	150	30.0	9.0	1.86	100	PLT	T	Stock	4688-1710	37.04
Black	3	76.2	150	30.0	9.0	1.86	200	PLT	T	MTO	4688-1711	37.04
Black	4	101.6	150	30.0	12.0	2.59	100	PLT	T	Stock	4688-1712	52.36
Black	4	101.6	150	30.0	12.0	2.59	200	PLT	T	MTO	4688-1713	52.36

#### Corrugated Cover

Color	Hose I.D.	Hose O.D.	Max. W.P.	Vac.	MBR	Wt. Per ft	Length	Std. Pack	Pkg Code	Stock or MTO	Gates Item No.	List Price Per ft
	(in)											
Black	1	25.4	150	30.0	3.0	.59	100	PLT	T	MTO	4688-1718	\$19.09
Black	1	25.4	150	30.0	3.0	.59	200	PLT	T	MTO	4688-1719	19.09
Black	1 1/4	31.8	150	30.0	4.0	.70	100	PLT	T	Stock	4688-1720	20.89
Black	1 1/4	31.8	150	30.0	4.0	.70	200	PLT	T	MTO	4688-1721	20.89
Black	1 1/2	38.1	150	30.0	4.0	.87	100	PLT	T	Stock	4688-1722	22.91
Black	1 1/2	38.1	150	30.0	4.0	.87	200	PLT	T	MTO	4688-1723	22.91
Black	2	50.8	150	30.0	6.0	.59	100	PLT	T	Stock	4688-1724	24.09
Black	2	50.8	150	30.0	6.0	.59	200	PLT	T	MTO	4688-1725	24.09
Black	2 1/2	63.5	150	30.0	8.0	1.47	100	PLT	T	MTO	4688-1726	32.13
Black	2 1/2	63.5	150	30.0	8.0	1.47	200	PLT	T	MTO	4688-1727	32.13
Black	3	76.2	150	30.0	9.0	1.86	100	PLT	T	Stock	4688-1728	37.04
Black	3	76.2	150	30.0	9.0	1.86	200	PLT	T	MTO	4688-1729	37.04
Black	4	101.6	150	30.0	12.0	2.59	100	PLT	T	MTO	4688-1730	52.36
Black	4	101.6	150	30.0	12.0	2.59	200	PLT	T	MTO	4688-1731	52.36

**RECOMMENDED FOR:** Fuel Master™ XTreme™ is designed and engineered specifically for constant contact use in the transfer of alternative fuels such as bio-diesel, bio-diesel blends, ethanol and ethanol blends. It can also be used for constant contact use in the transfer of commercial gasolines, diesel fuels, oils and other petroleum products. It is ideal for tank truck, terminal loading and in-plant operations.

**CAUTION:** Service life of transfer hoses can be extended by draining hoses after use.

**TEMPERATURE:** -30°F to +180°F (-34°C to +82°C). Warning: Do not convey fuels over +120°F (+49°C). Contact Denver Product Application (303) 744-5070 for use at temperature extremes.

**CONSTRUCTION:** **Tube:** Type C (Nitrile). Black.  
**Reinforcement:** Synthetic, high tensile textile with steel wire helix.  
**Cover:** Type C2 (Modified Nitrile). Black with red stripe.  
**Design Factor:** 4:1

**COUPLINGS:** 7, 26, 49 or 78. (for ambient temperatures only). Reference the Hose Coupling Section.

**STANDARDS:** **Tube:** ARPM (Class A) High oil-resistance.  
**Cover:** ARPM (Class A) High oil-resistance.  
 Meets MSHA Flame-resistant.

AGRICULTURE

AIR BREATHING

AIR DUCT

AIR AND MULTI-PURPOSE

CHEMICAL

FOOD AND BEVERAGE

MARINE AND ENGINE

MATERIAL HANDLING

MINING

OILFIELD

PETROLEUM

PRESSURE WASH AND WASHDOWN

STEAM

WATER

CLAMPS

COUPLINGS AND FERRULES

HOSE FINDER

CHEMICAL RESISTANCE TABLE

## Petroleum Hose

### Fuel Master™ XTreme™ 150SD MegaFlex® Formerly - Petroleum Drop 150SD MegaFlex®



AGRICULTURE
AIR BREATHING
AIR DUCT
AIR AND MULTI-PURPOSE
CHEMICAL
FOOD AND BEVERAGE
MARINE AND ENGINE
MATERIAL HANDLING
MINING
OILFIELD
PETROLEUM
PRESSURE WASH AND WASHDOWN
STEAM
WATER
CLAMPS
COUPLINGS AND FERRULES
HOSE FINDER
CHEMICAL RESISTANCE TABLE

Color	Hose I.D.		Hose O.D.		Max. W.P.		Vac.	MBR	Wt. Per ft	Length	Std. Pack	Pkg Code	Stock or MTO	Gates Item No.	List Price Per ft
	(in)	(mm)	(in)	(mm)	(psi)	(Bar)									
Red	2	50.8	2.45	62.2	150	10.3	30.0	2.0	.94	100	PLT	T	Stock	4688-2011	\$37.97
Red	2	50.8	2.45	62.2	150	10.3	30.0	2.0	1.13	200	PLT	T	MTO	4688-2012	37.97
Red	3	76.2	3.44	87.4	150	10.3	30.0	3.0	1.65	100	PLT	T	Stock	4688-2015	48.71
Red	3	76.2	3.44	87.4	150	10.3	30.0	3.0	1.78	200	PLT	T	MTO	4688-2016	48.71
Red	4	101.6	4.48	113.8	150	10.3	30.0	4.0	2.16	100	PLT	T	Stock	4688-2017	65.68
Red	4	101.6	4.48	113.8	150	10.3	30.0	4.0	2.16	200	PLT	T	MTO	4688-2018	65.68

**RECOMMENDED FOR:** Transfer of commercial gasoline, diesel fuels, oils and other petroleum products including bio-diesel, bio-diesel blends, ethanol and ethanol blends. It is ideal for tank truck, terminal loading and in-plant operations and oilfield service truck use where a super flexible, maximum kink-resistant fuel transfer hose is needed. Hose life can be extended by draining hose after use.

**TEMPERATURE:** -30°F to +180°F (-34°C to +82°C) continuous service.

**CONSTRUCTION:**  
**Tube:** Type C (Nitrile). Black.  
**Reinforcement:** Synthetic, high tensile textile with dual wire helix.  
**Cover:** Type C2 (Modified Nitrile). Red corrugated with black stripe.  
**Design Factor:** 4:1

**COUPLINGS:** 7, 26, 49 or 73. Crimp Sleeves (78) can be used with cam and groove type stems (49) at temperatures below +125°F (+52°C). Reference the Hose Coupling Section.

**STANDARDS:** **Tube:** ARPM (Class A) High oil-resistance.

## Petroleum Hose

### Fuel Master™ 150SD

Formerly - Longhorn®



#### Smooth Cover

Color	Hose I.D.		Hose O.D.		Max. W.P.		Vac.	MBR	Wt. Per ft	Length	Std. Pack	Pkg Code	Stock or MTO	Gates Item No.	List Price Per ft
	(in)	(mm)	(in)	(mm)	(psi)	(Bar)									
Black	1	25.4	1.50	38.1	150	10.3	30.0	3.0	.54	100	PLT	T	Stock	4688-1305	\$17.36
Black	1	25.4	1.50	38.1	150	10.3	30.0	3.0	.54	200	PLT	T	MTO	4688-0454	17.36
Black	1 1/4	31.8	1.75	44.5	150	10.3	30.0	4.0	.71	100	PLT	T	Stock	4688-1306	18.99
Black	1 1/2	38.1	2.02	51.3	150	10.3	30.0	4.0	1.05	100	PLT	T	Stock	4688-1307	20.83
Black	1 1/2	38.1	2.02	51.3	150	10.3	30.0	4.0	1.05	200	PLT	T	MTO	4688-1493	20.83
Black	2	50.8	2.52	64.0	150	10.3	30.0	6.0	1.34	100	PLT	T	Stock	4688-1308	21.90
Black	2	50.8	2.52	64.0	150	10.3	30.0	6.0	1.34	200	PLT	T	MTO	4688-1342	21.90
Black	2 1/2	63.5	3.05	77.5	150	10.3	30.0	8.0	1.76	100	PLT	T	Stock	4688-1309	29.20
Black	2 1/2	63.5	3.05	77.5	150	10.3	30.0	8.0	1.76	200	PLT	T	MTO	4688-0455	29.20
Black	3	76.2	3.53	89.7	150	10.3	30.0	9.0	2.40	100	PLT	T	Stock	4688-1310	33.67
Black	3	76.2	3.53	89.7	150	10.3	30.0	9.0	2.40	200	PLT	T	MTO	4688-1343	33.67
Black	4	101.6	4.57	116.1	150	10.3	30.0	12.0	3.29	100	PLT	T	Stock	4688-1311	47.60
Black	4	101.6	4.57	116.1	150	10.3	30.0	12.0	3.29	200	PLT	T	MTO	4688-1344	47.60
Black	6	152.4	6.79	172.5	150	10.3	30.0	17.0	7.51	100	PLT	T	MTO	4688-1465	114.24

#### Corrugated Cover

Color	Hose I.D.		Hose O.D.		Max. W.P.		Vac.	MBR	Wt. Per ft	Length	Std. Pack	Pkg Code	Stock or MTO	Gates Item No.	List Price Per ft
	(in)	(mm)	(in)	(mm)	(psi)	(Bar)									
Black	2	50.8	2.52	64.0	150	10.3	30.0	5.0	1.08	100	PLT	T	Stock	4688-1351	\$21.90
Black	2 1/2	63.5	3.05	77.5	150	10.3	30.0	8.0	1.40	100	PLT	T	MTO	4688-1511	29.20
Black	3	76.2	3.53	89.7	150	10.3	30.0	8.0	2.67	100	PLT	T	Stock	4688-1352	33.67
Black	4	101.6	4.64	117.9	150	10.3	30.0	11.0	3.14	100	PLT	T	Stock	4688-1353	47.60
Black	6	152.4	6.79	172.5	150	10.3	30.0	17.0	7.51	50	PLT	T	Stock	4688-1355	114.24
Black	6	152.4	6.79	172.5	150	10.3	30.0	17.0	5.46	100	PLT	T	MTO	4688-1612	114.24
Black	6	152.4	6.79	172.5	150	10.3	30.0	17.0	5.91	200	PLT	T	Stock	4688-1362	114.24

**RECOMMENDED FOR:** Transfer of refined fuels (commercial gasoline and diesel fuel), oils and other petroleum products. Ideal for oilfield service truck use.

**CAUTION:** Service life of transfer hoses can be extended by draining hoses after use. For Bio-Diesel and other alternative fuel applications, see Fuel Master™ XTreme™. Petroleum transfer hoses may be used with all grades of Bio-Diesel only if the exposure is intermittent and the hose is drained between uses.

**TEMPERATURE:** -40°F to +180°F (-40°C to +82°C). Warning: Do not convey fuels over +120°F (+49°C).

**CONSTRUCTION:** **Tube:** Type C (Nitrile). Black.  
**Reinforcement:** Synthetic, high tensile textile with steel wire helix.  
**Cover:** Type A (Chloroprene). Black corrugated with red stripe.  
**Design Factor:** 4:1

**COUPLINGS:** 7, 26, 49 or 78. (for ambient temperatures only). Reference the Hose Coupling Section.

**STANDARDS:** **Tube:** ARP (Class A) High oil-resistance.

AGRICULTURE

AIR BREATHING

AIR DUCT

AIR AND MULTI-PURPOSE

CHEMICAL

FOOD AND BEVERAGE

MARINE AND ENGINE

MATERIAL HANDLING

MINING

OILFIELD

PETROLEUM

PRESSURE WASH AND WASHDOWN

STEAM

WATER

CLAMPS

COUPLINGS AND FERRULES

HOSE FINDER

CHEMICAL RESISTANCE TABLE

## Petroleum Hose

### Fuel Master™ 150SD MegaFlex® Formerly - Longhorn® MegaFlex®



AGRICULTURE
AIR BREATHING
AIR DUCT
AIR AND MULTI-PURPOSE
CHEMICAL
FOOD AND BEVERAGE
MARINE AND ENGINE
MATERIAL HANDLING
MINING
OILFIELD
PETROLEUM
PRESSURE WASH AND WASHDOWN
STEAM
WATER
CLAMPS
COUPLINGS AND FERRULES
HOSE FINDER
CHEMICAL RESISTANCE TABLE

Color	Hose I.D.		Hose O.D.		Max. W.P.		Vac.	MBR	Wt. Per ft	Length	Std. Pack	Pkg Code	Stock or MTO	Gates Item No.	List Price Per ft
	(in)	(mm)	(in)	(mm)	(psi)	(Bar)									
Black	1	25.4	1.41	35.8	150	10.3	30.0	1.0	.46	100	PLT	T	MTO	4688-1732	\$19.09
Black	1 1/2	38.1	1.90	48.3	150	10.3	30.0	1.5	.72	100	PLT	T	Stock	4688-2031	22.91
Black	2	50.8	2.39	60.7	150	10.3	30.0	2.0	.86	100	PLT	T	Stock	4688-1733	24.09
Black	3	76.2	3.44	87.4	150	10.3	30.0	3.0	1.45	100	PLT	T	Stock	4688-1734	37.04
Black	4	101.6	4.48	113.8	150	10.3	30.0	4.0	2.29	100	PLT	T	Stock	4688-1735	52.36
Black	6	152.4	6.55	166.4	150	10.3	30.0	6.0	4.15	100	PLT	T	MTO	4688-2033	125.66

**RECOMMENDED FOR:** Transfer of refined fuels (commercial gasoline and diesel fuel), oils and other petroleum products. Ideal for tank truck, fuel farm, and oilfield service truck use where a super flexible, maximum kink-resistant fuel transfer hose is needed.

**CAUTION:** Service life of transfer hoses can be extended by draining hoses after use.

**TEMPERATURE:** -40°F to +180°F (-40°C to +82°C). Warning: Do not convey fuels over +120°F (+49°C).

**CONSTRUCTION:**  
**Tube:** Type C (Nitrile). Black.  
**Reinforcement:** Synthetic, high tensile textile reinforcement with steel wire helix.  
**Cover:** Type A (Chloroprene). Black corrugated with red stripe.  
**Design Factor:** 4:1

**COUPLINGS:** 7, 26, 49 or 78. (for ambient temperatures only).

**STANDARDS:** **Tube:** ARPM (Class A) High oil-resistance.

## Petroleum Hose

### Fuel Master™ 150SD LT MegaFlex® Formerly - Arctic Longhorn® MegaFlex®



Color	Hose I.D.		Hose O.D.		Max. W.P.		Vac.	MBR	Wt. Per ft	Length	Std. Pack	Pkg Code	Stock or MTO	Gates Item No.	List Price Per ft
	(in)	(mm)	(in)	(mm)	(psi)	(Bar)	(In. Hg)	(in)	(Lbs.)	(ft)			(ft)		
Blue	2	50.8	2.38	60.5	150	10.3	30.0	2.0	1.13	100	PLT	T	Stock	4688-2040	\$27.82
Blue	2	50.8	2.38	60.5	150	10.3	30.0	2.0	1.13	200	PLT	T	MTO	4688-2041	27.82
Blue	3	76.2	3.44	87.4	150	10.3	30.0	3.0	1.61	100	PLT	T	Stock	4688-2042	38.52
Blue	3	76.2	3.44	87.4	150	10.3	30.0	3.0	1.13	200	PLT	T	MTO	4688-2043	38.52
Blue	4	101.6	4.49	114.0	150	10.3	30.0	4.0	1.13	100	PLT	T	Stock	4688-2044	51.59
Blue	4	101.6	4.49	114.0	150	10.3	30.0	4.0	1.13	200	PLT	T	MTO	4688-2045	51.59

**RECOMMENDED FOR:** Transfer of refined fuels (commercial gasoline and diesel fuel), oils and other petroleum products. It is ideal for tank truck, fuel farm and oilfield service truck use where a super flexible cold weather fuel transfer hose is needed. Hose life can be extended by draining hose after use. Hose maintains flexibility down to -65°F.

**CAUTION:** Service life of transfer hoses can be extended by draining hoses after use.

**TEMPERATURE:** -65°F to +180°F (-54°C to +82°C) continuous service.

**CONSTRUCTION:**  
**Tube:** Type C (Nitrile). Black.  
**Reinforcement:** Synthetic, high tensile textile with dual wire helix.  
**Cover:** Type A (Chloroprene). Blue corrugated with black stripe.  
**Design Factor:** 4:1

**COUPLINGS:** 7, 26, 49 or 78. (for ambient temperatures only). Reference the Hose Coupling Section.

**STANDARDS:** **Tube:** ARPM (Class A) High oil-resistance.

AGRICULTURE

AIR BREATHING

AIR DUCT

AIR AND MULTI-PURPOSE

CHEMICAL

FOOD AND BEVERAGE

MARINE AND ENGINE

MATERIAL HANDLING

MINING

OILFIELD

PETROLEUM

PRESSURE WASH AND WASHDOWN

STEAM

WATER

CLAMPS

COUPLINGS AND FERRULES

HOSE FINDER

CHEMICAL RESISTANCE TABLE



## Petroleum Hose

### Fuel Master™ 150D Formerly - Steer®



AGRICULTURE
AIR BREATHING
AIR DUCT
AIR AND MULTI-PURPOSE
CHEMICAL
FOOD AND BEVERAGE
MARINE AND ENGINE
MATERIAL HANDLING
MINING
OILFIELD
PETROLEUM
PRESSURE WASH AND WASHDOWN
STEAM
WATER
CLAMPS
COUPLINGS AND FERRULES
HOSE FINDER
CHEMICAL RESISTANCE TABLE

Color	Hose I.D.		Hose O.D.		Max. W.P.		Vac.	MBR	Wt. Per ft	Length	Std. Pack	Pkg Code	Stock or MTO	Gates Item No.	List Price Per ft
	(in)	(mm)	(in)	(mm)	(psi)	(Bar)									
Black	2	50.8	2.44	62.0	150	10.3	—	—	.92	100	PLT	T	Stock	4688-1320	\$19.71
Black	2	50.8	2.44	62.0	150	10.3	—	—	.92	200	PLT	T	MTO	4688-1491	19.71
Black	3	76.2	3.45	87.6	150	10.3	—	—	1.37	100	PLT	T	Stock	4688-1321	30.31
Black	3	76.2	3.45	87.6	150	10.3	—	—	1.37	200	PLT	T	MTO	4688-1530	30.31
Black	4	101.6	4.51	114.6	150	10.3	—	—	2.03	100	PLT	T	Stock	4688-1322	42.84
Black	4	101.6	4.51	114.6	150	10.3	—	—	2.03	200	PLT	T	MTO	4688-1531	42.84

**RECOMMENDED FOR:** Transfer of refined fuels (commercial gasoline and diesel fuel), oils and other petroleum products. Ideal for oilfield service truck use.

**CAUTION:** Service life of transfer hoses can be extended by draining hoses after use. For Bio-Diesel and other alternative fuel applications, see Fuel Master™ XTreme™. Petroleum transfer hoses may be used with all grades of Bio-Diesel only if the exposure is intermittent and the hose is drained between uses.

**TEMPERATURE:** -40°F to +180°F (-40°C to +82°C). Warning: Do not convey fuels over +120°F (+49°C).

**CONSTRUCTION:**  
**Tube:** Type C (Nitrile). Black.  
**Reinforcement:** Braided, high tensile synthetic textile cord with static conductor.  
**Cover:** Type A (Chloroprene). Black with red stripe.  
**Design Factor:** 4:1

**COUPLINGS:** 7, 26, 49 or 78. (for ambient temperatures only). Reference the Hose Coupling Section.

**STANDARDS:** **Tube:** ARPM (Class A) High oil-resistance.

## Petroleum Hose

### Fuel Master™ 100SD Formerly - Maverick™



Color	Hose I.D.	Hose O.D.	Max. W.P.	Vac.	MBR	Wt. Per ft	Length	Std. Pack	Pkg Code	Stock or MTO	Gates Item No.	List Price Per ft			
	(in)	(mm)											(in)	(mm)	(psi)
Red	2	50.8	2.48	63.0	100	6.9	30.0	4.0	1.11	100	PLT	T	Stock	4687-0251	\$19.32
Red	2	50.8	2.48	63.0	100	6.9	30.0	4.0	1.35	200	PLT	T	MTO	4687-0200	19.32
Red	3	76.2	3.50	88.9	100	6.9	30.0	6.0	1.71	100	PLT	T	Stock	4687-0252	29.70
Red	4	101.6	4.50	114.3	100	6.9	30.0	11.0	2.38	100	PLT	T	Stock	4687-0253	41.99

**RECOMMENDED FOR:** Transfer of refined fuels (commercial gasoline and diesel fuel), oils and other petroleum products. Ideal for oilfield service truck use.

**CAUTION:** Service life of transfer hoses can be extended by draining hoses after use. For Bio-Diesel and other alternative fuel applications, see Fuel Master™ XTreme™. Petroleum transfer hoses may be used with all grades of Bio-Diesel only if the exposure is intermittent and the hose is drained between uses.

**TEMPERATURE:** -40°F to +180°F (-40°C to +82°C). Warning: Do not convey fuels over +120°F (+49°C).

**CONSTRUCTION:**  
**Tube:** Type C (Nitrile). Black.  
**Reinforcement:** Synthetic, high tensile textile with steel wire helix.  
**Cover:** Type C2 (Modified Nitrile). Red corrugated with white stripe.  
**Design Factor:** 4:1

**COUPLINGS:** 7, 26, 49 or 78. (for ambient temperatures only). Reference the Hose Coupling Section.

**STANDARDS:** **Tube:** ARPM (Class A) High oil-resistance.

AGRICULTURE

AIR BREATHING

AIR DUCT

AIR AND MULTI-PURPOSE

CHEMICAL

FOOD AND BEVERAGE

MARINE AND ENGINE

MATERIAL HANDLING

MINING

OILFIELD

PETROLEUM

PRESSURE WASH AND WASHDOWN

STEAM

WATER

CLAMPS

COUPLINGS AND FERRULES

HOSE FINDER

CHEMICAL RESISTANCE TABLE

## Petroleum Hose

### Fuel Master™ PVC 65SD Formerly - Master-Flex® Fuel Delivery



AGRICULTURE
AIR BREATHING
AIR DUCT
AIR AND MULTI-PURPOSE
CHEMICAL
FOOD AND BEVERAGE
MARINE AND ENGINE
MATERIAL HANDLING
MINING
OILFIELD
PETROLEUM
PRESSURE WASH AND WASHDOWN
STEAM
WATER
CLAMPS
COUPLINGS AND FERRULES
HOSE FINDER
CHEMICAL RESISTANCE TABLE

Color	Hose I.D.	Hose O.D.	Max. W.P.*	Vac.*	MBR	Wt. Per ft	Length	Std. Pack	Pkg Code	Stock or MTO (ft)	Gates Item No.	List Price Per ft			
	(in)	(mm)	(in)	(mm)	(psi)	(Bar)	(In. Hg)						(in)	(Lbs.)	(ft)
Black	3	76.2	3.76	95.5	65	4.5	28.0	6.0	1.71	100	PLT	T	Stock	7744-7103	\$45.42
Black	4	101.6	4.79	121.7	65	4.5	28.0	8.0	2.44	100	PLT	T	Stock	7744-7104	58.31

NOTE: \* Working Pressure and Vacuum at +72°F (+22°C).

**RECOMMENDED FOR:** Transfer of commercial gasolines, diesel fuel, oils and other petroleum products. Ideal for oilfield service truck use.

**TEMPERATURE:** -30°F to +130°F (-34°C to +55°C). Warning: Do not convey fuels over +120°F (+49°C).

**CONSTRUCTION:**  
**Tube:** Type C3 (Modified Nitrile). Black.  
**Reinforcement:** Polyester fabric with static wire.  
**Cover:** Type G (PVC). Black with yellow helix.  
**Design Factor:** 4:1

**COUPLINGS:** 6, 7, 49 or 78. Reference the Hose Coupling Section.

Fuel Master™ PVC 65SD Sleeve



Color	Hose I.D.		Wt. Per ea (Lbs.)	Length (ea)	Std. Pack	Pkg Code	Stock or MTO	Gates Item No.	List Price Per ea
	(in)	(mm)					(ea)		
Black	3	76.2	5.13	3	Ctn	T	MTO	7744-8103	\$67.86
Black	4	101.6	7.32	3	Ctn	T	MTO	7744-8104	75.96

**RECOMMENDED FOR:** Soft black PVC sleeve is designed to fit Gates Fuel Delivery Hose and provides a smooth banding surface.

**INSTALLATION:** Apply the sleeve by twisting in a clockwise direction. Use of an appropriate lubricant, i.e. soapy water solution, will simplify sleeve application and reduce possibility of damage to hose cover. Make sure sleeve is applied prior to coupling insertion.

AGRICULTURE
AIR BREATHING
AIR DUCT
AIR AND MULTI-PURPOSE
CHEMICAL
FOOD AND BEVERAGE
MARINE AND ENGINE
MATERIAL HANDLING
MINING
OILFIELD
PETROLEUM
PRESSURE WASH AND WASHDOWN
STEAM
WATER
CLAMPS
COUPLINGS AND FERRULES
HOSE FINDER
CHEMICAL RESISTANCE TABLE

**Fuel Master™ PVC Vapor Recovery 5SD**  
Formerly - Master-Flex® Vapor Recovery



AGRICULTURE
AIR BREATHING
AIR DUCT
AIR AND MULTI-PURPOSE
CHEMICAL
FOOD AND BEVERAGE
MARINE AND ENGINE
MATERIAL HANDLING
MINING
OILFIELD
PETROLEUM
PRESSURE WASH AND WASHDOWN
STEAM
WATER
CLAMPS
COUPLINGS AND FERRULES
HOSE FINDER
CHEMICAL RESISTANCE TABLE

Color	Hose I.D.	Hose O.D.	Max. W.P.*	Vac.*	MBR	Wt. Per ft	Length	Std. Pack	Pkg Code	Stock or MTO	Gates Item No.	List Price Per ft			
	(in)	(mm)											(in)	(mm)	(psi)
Clear	1 1/2	38.1	1.88	47.8	5	.3	—	1.5	.36	100	Ctn	T	Stock	7744-7015	\$12.84
Clear	2	50.8	2.43	61.7	5	.3	—	2.0	.48	100	Ctn	T	Stock	7744-7020	16.53
Clear	3	76.2	3.54	89.9	5	.3	—	3.0	.69	100	Ctn	T	Stock	7744-7030	29.93
Clear	4	101.6	4.56	115.8	5	.3	—	4.0	.92	100	Ctn	T	Stock	7744-7040	44.25
Clear	5	127.0	5.51	140.0	5	.3	—	5.0	1.13	100	Ctn	T	Stock	7744-7050	52.28
Clear	6	152.4	6.52	165.6	5	.3	—	6.0	1.24	100	Ctn	T	Stock	7744-7060	85.32

NOTE: \* Working Pressure and Vacuum at +72°F (+22°C).

**RECOMMENDED FOR:** Vapor Recovery for use with Gates Fuel Master™ and Fuel Master™ PVC. Can also be used for ducting, dust and light abrasive material handling.

**TEMPERATURE:** -30°F to +140°F (-34°C to +60°C) continuous service.

**CONSTRUCTION:**  
**Tube:** Type U (Polyurethane). Clear.  
**Reinforcement:** Rigid yellow PVC helix with copper static wire.  
**Cover:** Type G (PVC). Clear with yellow helix.  
**Design Factor:** N/A

**COUPLINGS:** 7, 26, 49 or 78. Reference the Hose Coupling Section.

### Fuel Master™ PVC Vapor Recovery 5SD Sleeve



Color	Hose I.D.		Wt. Per ea (Lbs.)	Length (ea)	Std. Pack	Pkg Code	Stock or MTO (ea)	Gates Item No.	List Price Per ea
	(in)	(mm)							
Gray	3	76.2	5.13	3	Ctn	T	MTO	7744-8030	\$67.86
Gray	4	101.6	7.32	3	Ctn	T	Stock	7744-8040	75.96

**RECOMMENDED FOR:** Soft gray PVC sleeve is designed to fit Gates Vapor Recovery Hose and provides a smooth banding surface.

**CONSTRUCTION:** Design Factor: N/A

**INSTALLATION:** Apply the sleeve by twisting in a clockwise direction. Use of an appropriate lubricant, i.e. soapy water solution, will simplify sleeve application and reduce possibility of damage to hose cover. Make sure sleeve is applied prior to coupling insertion.

AGRICULTURE

AIR BREATHING

AIR DUCT

AIR AND MULTI-PURPOSE

CHEMICAL

FOOD AND BEVERAGE

MARINE AND ENGINE

MATERIAL HANDLING

MINING

OILFIELD

PETROLEUM

PRESSURE WASH AND WASHDOWN

STEAM

WATER

CLAMPS

COUPLINGS AND FERRULES

HOSE FINDER

CHEMICAL RESISTANCE TABLE

## Petroleum Hose

### Fuel Master™ Delivery 200 Formerly - Fuel Oil Delivery



AGRICULTURE
AIR BREATHING
AIR DUCT
AIR AND MULTI-PURPOSE
CHEMICAL
FOOD AND BEVERAGE
MARINE AND ENGINE
MATERIAL HANDLING
MINING
OILFIELD
PETROLEUM
PRESSURE WASH AND WASHDOWN
STEAM
WATER
CLAMPS
COUPLINGS AND FERRULES
HOSE FINDER
CHEMICAL RESISTANCE TABLE

Color	Hose I.D.	Hose O.D.	Max. W.P.	Vac.	MBR	Wt. Per ft	Length	Std. Pack	Pkg Code	Stock or MTO	Gates Item No.	List Price Per ft			
	(in)	(mm)											(in)	(mm)	(psi)
Red	1	25.4	1.50	38.1	200	13.8	10.0	8.0	.58	100	Ctn	T	Stock	3221-0410	\$15.21
Red	1	25.4	1.50	38.1	200	13.8	10.0	8.0	.58	125	Ctn	T	Stock	3221-0411	15.21
Red	1	25.4	1.50	38.1	200	13.8	10.0	8.0	.58	150	Ctn	T	Stock	3221-0412	15.21
Red	1	25.4	1.50	38.1	200	13.8	10.0	8.0	.58	175	Ctn	T	Stock	3221-0413	15.21
Red	1 1/4	31.8	1.75	44.5	200	13.8	10.0	10.0	.75	100	Ctn	T	Stock	3221-0414	17.67
Red	1 1/4	31.8	1.75	44.5	200	13.8	10.0	10.0	.75	125	Ctn	T	Stock	3221-0415	17.67
Red	1 1/4	31.8	1.75	44.5	200	13.8	10.0	10.0	.75	150	Ctn	T	Stock	3221-0416	17.67
Red	1 1/4	31.8	1.75	44.5	200	13.8	10.0	10.0	.75	175	Ctn	T	Stock	3221-0417	17.67
Red	1 3/8	34.9	1.87	47.5	200	13.8	10.0	10.0	.86	100	Ctn	T	Stock	3221-0418	20.19
Red	1 3/8	34.9	1.87	47.5	200	13.8	10.0	10.0	.86	125	Ctn	T	Stock	3221-0419	20.19
Red	1 3/8	34.9	1.87	47.5	200	13.8	10.0	10.0	.86	150	Ctn	T	Stock	3221-0420	20.19
Red	1 3/8	34.9	1.87	47.5	200	13.8	10.0	10.0	.86	175	Ctn	T	Stock	3221-0421	20.19
Red	1 1/2	38.1	2.08	52.8	200	13.8	10.0	12.0	.95	100	PLT	T	Stock	3221-0422	25.50
Red	1 1/2	38.1	2.08	52.8	200	13.8	10.0	12.0	.95	125	PLT	T	Stock	3221-0423	25.50
Red	1 1/2	38.1	2.08	52.8	200	13.8	10.0	12.0	.95	150	PLT	T	Stock	3221-0424	25.50
Red	1 1/2	38.1	2.08	52.8	200	13.8	10.0	12.0	.95	175	PLT	T	Stock	3221-0425	25.50
Red	1 1/2	38.1	2.08	52.8	200	13.8	10.0	12.0	.95	200	PLT	T	Stock	3221-0426	25.50

**RECOMMENDED FOR:** Transferring fuel oils, diesel fuel or commercial gasolines in applications at temperatures as low as -40°F (-40°C). Compatible with Bio-Diesel fuels up to B20. Hose remains flexible to -20°F (-29°C). For home and heavy-duty commercial service where an abrasion-resistant and non-marking cover is required.

**CAUTION:** Gasoline is normally conveyed below +120°F (+49°C).

**TEMPERATURE:** -40°F to +180°F (-40°C to +82°C) continuous service.

**CONSTRUCTION:** **Tube:** Type C (Nitrile). Black.  
**Reinforcement:** High tensile synthetic textile cord.  
**Cover:** Type C4 (Carboxylated Nitrile). Red. Abrasion-resistant and non-marking.  
**Design Factor:** 4:1

**COUPLINGS:** 26 or 49. Reference the Hose Coupling Section.

**STANDARDS:** **Tube:** ARPM (Class A) High oil-resistance.  
**Cover:** Meets MSHA Flame-resistant.

## Petroleum Hose

### Fuel Master™ Delivery 200 Assemblies



Color	Hose I.D.		Hose O.D.		Max. W.P.		Vac.	MBR	Wt. Per ea	Length	Std. Pack	Pkg Code	Stock or MTO	Gates Item No.	List Price Per ea
	(in)	(mm)	(in)	(mm)	(psi)	(Bar)									
Red	1	25.4	1.50	38.1	200	13.8	10.0	8.0	64.20	100	Assy	T	MTO	3221-0075	\$2,429.12
Red	1	25.4	1.50	38.1	200	13.8	10.0	8.0	75.50	125	Assy	T	MTO	3221-0076	2,662.56
Red	1	25.4	1.50	38.1	200	13.8	10.0	8.0	90.00	150	Assy	T	MTO	3221-0077	2,876.03
Red	1	25.4	1.50	38.1	200	13.8	10.0	8.0	104.50	175	Assy	T	MTO	3221-0078	3,176.93
Red	1 1/4	31.8	1.75	44.5	200	13.8	10.0	10.0	79.00	100	Assy	T	MTO	3221-0079	3,051.86
Red	1 1/4	31.8	1.75	44.5	200	13.8	10.0	10.0	115.00	125	Assy	T	MTO	3221-0080	3,495.30
Red	1 1/4	31.8	1.75	44.5	200	13.8	10.0	10.0	121.00	150	Assy	T	MTO	3221-0081	3,894.84
Red	1 1/4	31.8	1.75	44.5	200	13.8	10.0	10.0	135.25	175	Assy	T	MTO	3221-0082	4,299.21
Red	1 3/8	34.9	1.87	47.5	200	13.8	10.0	10.0	84.00	100	Assy	T	MTO	3221-0083	3,177.93
Red	1 3/8	34.9	1.87	47.5	200	13.8	10.0	10.0	104.00	125	Assy	T	MTO	3221-0084	3,636.93
Red	1 3/8	34.9	1.87	47.5	200	13.8	10.0	10.0	137.00	150	Assy	T	MTO	3221-0085	4,059.59
Red	1 3/8	34.9	1.87	47.5	200	13.8	10.0	10.0	140.50	175	Assy	T	MTO	3221-0086	4,739.12
Red	1 1/2	38.1	2.08	52.8	200	13.8	10.0	12.0	100.00	100	Assy	T	MTO	3221-0087	3,953.12
Red	1 1/2	38.1	2.08	52.8	200	13.8	10.0	12.0	123.75	125	Assy	T	MTO	3221-0088	4,529.63
Red	1 1/2	38.1	2.08	52.8	200	13.8	10.0	12.0	135.00	150	Assy	T	MTO	3221-0089	5,139.11
Red	1 1/2	38.1	2.08	52.8	200	13.8	10.0	12.0	171.25	175	Assy	T	MTO	3221-0090	5,738.81
Red	1 1/2	38.1	2.08	52.8	200	13.8	10.0	12.0	195.00	200	Assy	T	MTO	3221-0095	6,362.48

NOTE: Coupled with Brass Internal Expansion Fittings Male/Female Swivel.

**RECOMMENDED FOR:** Transferring fuel oils, diesel fuel or commercial gasolines in applications at temperatures as low as -40°F (-40°C). Compatible with Bio-Diesel fuels up to B20. Hose remains flexible to -20°F (-29°C). For home and heavy-duty commercial service where an abrasion-resistant and non-marking cover is required.

**CAUTION:** Gasoline is normally conveyed below +120°F (+49°C).

**TEMPERATURE:** -40°F to +180°F (-40°C to +82°C) continuous service. NOTE: Diesel fuel normally conveyed below +120°F (+49°C).

**CONSTRUCTION:**  
**Tube:** Type C (Nitrile). Black.  
**Reinforcement:** High tensile synthetic textile cord.  
**Cover:** Type C4 (Carboxylated Nitrile). Red. Abrasion-resistant and non-marking.  
**Design Factor:** 4:1

**COUPLINGS:** 26 or 49. Reference the Hose Coupling Section.

**STANDARDS:**  
**Tube:** ARPM (Class A) High oil-resistance.  
**Cover:** Meets MSHA Flame-resistant.

AGRICULTURE

AIR BREATHING

AIR DUCT

AIR AND MULTI-PURPOSE

CHEMICAL

FOOD AND BEVERAGE

MARINE AND ENGINE

MATERIAL HANDLING

MINING

OILFIELD

PETROLEUM

PRESSURE WASH AND WASHDOWN

STEAM

WATER

CLAMPS

COUPLINGS AND FERRULES

HOSE FINDER

CHEMICAL RESISTANCE TABLE



## Petroleum Hose

### LP350

Formerly - LP350, LP350X



### LP350

Color	Hose I.D.		Hose O.D.		Max. W.P.		Vac.	MBR	Wt. Per ft	Length	Std. Pack	Pkg Code	Stock or MTO	Gates Item No.	List Price Per ft
	(in)	(mm)	(in)	(mm)	(psi)	(Bar)									
Black	1/4	6.4	.58	14.7	350	24.1	30.0	3.0	.14	700	Reel	EE	Stock	3220-1200	\$4.49
Black	1/4	6.4	.58	14.7	350	24.1	30.0	3.0	.14	3700	PLT	Y	MTO	3220-1201	4.04
Black	3/8	9.5	.74	18.8	350	24.1	30.0	3.0	.21	700	Reel	EE	Stock	3220-1202	5.81
Black	3/8	9.5	.74	18.8	350	24.1	30.0	3.0	.21	2000	PLT	Y	MTO	3220-1203	5.22
Black	1/2	12.7	.91	23.1	350	24.1	25.0	5.0	.28	700	Reel	EE	Stock	3220-1204	7.79
Black	1/2	12.7	.91	23.1	350	24.1	25.0	5.0	.28	1000	PLT	SS	Stock	3220-1205	7.01
Black	3/4	19.1	1.23	31.2	350	24.1	20.0	6.0	.44	100	Ctn	T	Stock	3220-1207	15.02
Black	3/4	19.1	1.23	31.2	350	24.1	20.0	6.0	.44	125	Ctn	T	Stock	3220-1208	15.02
Black	3/4	19.1	1.23	31.2	350	24.1	20.0	6.0	.44	150	Ctn	T	Stock	3220-1209	15.02
Black	3/4	19.1	1.23	31.2	350	24.1	20.0	6.0	.44	350	Reel	KK	Stock	3220-1206	13.07
Black	1	25.4	1.51	38.4	350	24.1	15.0	8.0	.66	100	Ctn	T	Stock	3220-1211	18.89
Black	1	25.4	1.51	38.4	350	24.1	15.0	8.0	.60	125	Ctn	T	Stock	3220-1212	18.89
Black	1	25.4	1.51	38.4	350	24.1	15.0	8.0	.60	150	Ctn	T	Stock	3220-1213	18.89
Black	1	25.4	1.51	38.4	350	24.1	15.0	15.0	.63	200	Ctn	T	MTO	3220-1216	18.89
Black	1	25.4	1.51	38.4	350	24.1	15.0	8.0	.60	350	Reel	KK	Stock	3220-1210	16.43
Black	1 1/4	31.8	1.85	47.0	350	24.1	10.0	10.0	.98	300	Reel	G	Stock	3220-0855	32.69
Black	1 1/2	38.1	2.25	57.2	350	24.1	10.0	12.0	1.26	60	Ctn	T	Stock	3320-0935	41.67
Black	2	50.8	2.86	72.6	350	24.1	10.0	14.0	1.84	50	Ctn	T	MTO	3320-0939	53.10
Black	2	50.8	2.86	72.6	350	24.1	10.0	14.0	1.81	60	Ctn	T	Stock	3320-0938	53.10
Black	3	76.2	3.88	98.6	350	24.1	10.0	24.0	2.58	60	Ctn	T	Stock	3320-0934	89.57

### LP350 Power Crimp® Ferrules

Size	Wt. Per ea	Std. Pack	Pkg Code	Stock or MTO	Gates Item No.	List Price Per ea
(in)	(Lbs.)			(ea)		
3/4	.21	Bulk	150	Stock	7266-0735	\$13.80
3/4	.21	Bulk	1	Stock	7266-07355	13.80
1 1/2	.80	Bulk	20	Stock	7266-0734	91.10
1 1/2	.80	Bulk	1	Stock	7266-07345	91.10
2	1.72	Bulk	12	Stock	7266-0733	114.95
2	1.72	Bulk	1	Stock	7266-07335	114.95

NOTE: These ferrules are to be used with LP350 hose only.

**RECOMMENDED FOR:** Liquid or gaseous propane, butane or any combination of these two mixtures. Can be used for natural gas (not to exceed 50 psi) under certain conditions such as: open/outside areas and well ventilated factory buildings (if local building codes permit).

**CAUTION:** Not recommended for residential, office buildings or as fuel line hose on compressed natural gas vehicles. Contact Denver Product Application (303) 744-5070 for inspection and assembly testing information.

**TEMPERATURE:** -40°F to +180°F (-40°C to +82°C) continuous service. Warning: Do not convey LP Gas over +140°F (60°C).

**CONSTRUCTION:** **Tube:** Type A (Chloroprene). Black. 1 1/2" - 3".  
Type C (Nitrile). Black. 1/4" - 1 1/4".  
**Reinforcement:** Braided, synthetic high tensile cord. 1 1/4" - 3".  
High tensile synthetic textile cord. 1/4" - 1".  
**Cover:** Type A (Chloroprene). Black. All sizes are perforated.  
**Design Factor:** 5:1

**COUPLINGS:** 72 Gates Power Crimp® for 3/4", 1 1/2" and 2" I.D. or 75 Gates GLX® sizes 1/4" to 1 1/4". For Power Crimp® ferrules, reference the Hose Coupling Section. Do not use male swivel, reusable or O-ring type couplings. For 3" I.D. use Dixon LP Boss only.

**STANDARDS:** CAN/CGA-8.1-M86.  
NFPA 58, Section 8-3.5.  
Underwriters Laboratories Standard No. 21. (Applies to all sizes).

## Petroleum Hose

### LPG Vapor 125



Color	Hose I.D.		Hose O.D.		Max. W.P.		Vac.	MBR	Wt. Per ft	Length	Std. Pack	Pkg Code	Stock or MTO	Gates Item No.	List Price Per ft
	(in)	(mm)	(in)	(mm)	(psi)	(Bar)									
Black	3/16	4.8	.44	11.2	125	8.6	30.0	2.0	.08	700	Reel	AA	Stock	3220-0451	\$1.80
Black	1/4	6.4	.53	13.5	125	8.6	30.0	3.0	.11	700	Reel	AA	Stock	3220-0456	1.88
Black	3/8	9.5	.66	16.8	125	8.6	25.0	3.0	.14	700	Reel	AA	Stock	3220-0461	2.72

**RECOMMENDED FOR:** Flexible connector for conveying low-pressure LPG (vapor only) to many types of farm and industrial heating applications; e.g., space heaters.

**CAUTION:** This hose should not be used for liquid LPG or in UL approved appliances such as barbecue grills.

**TEMPERATURE:** -30°F to +150°F (-34°C to +66°C) continuous service.

**CONSTRUCTION:** **Tube:** Type C (Nitrile). Black.  
**Reinforcement:** High tensile synthetic textile cord.  
**Cover:** Type A (Chloroprene). Black.  
**Design Factor:** 5:1

**STANDARDS:** Underwriters Laboratories Standard No. 569. (Applies to hose assemblies only).

AGRICULTURE

AIR BREATHING

AIR DUCT

AIR AND MULTI-PURPOSE

CHEMICAL

FOOD AND BEVERAGE

MARINE AND ENGINE

MATERIAL HANDLING

MINING

OILFIELD

PETROLEUM

PRESSURE WASH AND WASHDOWN

STEAM

WATER

CLAMPS

COUPLINGS AND FERRULES

HOSE FINDER

CHEMICAL RESISTANCE TABLE

## Petroleum Hose

### Fuel Master™ Curb Pump 150 Formerly - Blacksnake®



AGRICULTURE
AIR BREATHING
AIR DUCT
AIR AND MULTI-PURPOSE
CHEMICAL
FOOD AND BEVERAGE
MARINE AND ENGINE
MATERIAL HANDLING
MINING
OILFIELD
<b>PETROLEUM</b>
PRESSURE WASH AND WASHDOWN
STEAM
WATER
CLAMPS
COUPLINGS AND FERRULES
HOSE FINDER
CHEMICAL RESISTANCE TABLE

Color	Hose I.D.	Hose O.D.	Max. W.P.	Vac.	MBR	Wt. Per ft	Length	Std. Pack	Pkg Code	Stock or MTO	Gates Item No.	List Price Per ft			
	(in)	(mm)											(in)	(mm)	(psi)
Black	5/8	15.9	1.00	25.4	150	10.3	30.0	6.0	.37	500	Reel	Z	Stock	3624-0001	\$8.52
Black	3/4	19.1	1.13	28.7	150	10.3	30.0	6.0	.42	500	Reel	Z	Stock	3624-0002	8.94
Black	1	25.4	1.38	35.1	150	10.3	30.0	8.0	.57	500	Reel	Z	Stock	3624-0003	13.13

- RECOMMENDED FOR:** Dispensing all types of commercial gasolines or other petroleum-based products, from service station pumps (curb pump). A heavy-duty hardwall hose which does not collapse in reel use or behind the nozzle in heavy-duty service.
- TEMPERATURE:** -40°F to +120°F (-40°C to +49°C) continuous service.
- CONSTRUCTION:** **Tube:** Type C (Nitrile). Black.  
**Reinforcement:** Braided, high tensile steel wire.  
**Cover:** Type J (CPE). Black. 5/8" and 3/4" smooth, 1" wrapped.  
**Design Factor:** 5:1
- COUPLINGS:** 24. Reference the Hose Coupling Section.
- STANDARDS:** Underwriters Laboratories Standard No. UL330 (USA) and ULC-S612-99 (Canada).  
**Tube:** ARPM (Class A) High oil-resistance.

## Petroleum Hose

### Fuel Master™ Diesel Curb Pump 150



Color	Hose I.D.		Hose O.D.		Max. W.P.		Vac.	MBR	Wt. Per ft	Length	Std. Pack	Pkg Code	Stock or MTO	Gates Item No.	List Price Per ft
	(in)	(mm)	(in)	(mm)	(psi)	(Bar)									
Green	3/4	19.1	1.13	28.7	150	10.3	30.0	6.0	.42	500	Reel	Z	MTO	3624-1007	\$9.39
Green	7/8	22.2	1.22	31.0	150	10.3	30.0	7.0	.42	500	Reel	Z	Stock	3624-1008	12.53
Green	1	25.4	1.38	35.1	150	10.3	30.0	8.0	.53	500	Reel	Z	Stock	3624-1009	13.79

**RECOMMENDED FOR:** Dispensing of all types of petroleum diesel fuels and Bio-Diesel blends from service station pumps. A heavy-duty hardwall hose which does not collapse in reel use or behind the nozzle in heavy-duty service.

**TEMPERATURE:** -40°F to +120°F (-40°C to +49°C) continuous service.

**CONSTRUCTION:**  
**Tube:** Type C (Nitrile). Black.  
**Reinforcement:** Braided, high tensile steel wire.  
**Cover:** Type J (CPE). Green. Smooth cover.  
**Design Factor:** 5:1

**COUPLINGS:** 24. Reference the Hose Coupling Section.

**STANDARDS:** Underwriters Laboratories Standard No. UL330 (USA) and ULC-S612 (Canada).  
**Tube:** ARPM (Class A) High oil-resistance.

AGRICULTURE

AIR BREATHING

AIR DUCT

AIR AND MULTI-PURPOSE

CHEMICAL

FOOD AND BEVERAGE

MARINE AND ENGINE

MATERIAL HANDLING

MINING

OILFIELD

PETROLEUM

PRESSURE WASH AND WASHDOWN

STEAM

WATER

CLAMPS

COUPLINGS AND FERRULES

HOSE FINDER

CHEMICAL RESISTANCE TABLE

## Pressure Wash and Washdown Hose

### Clean Master™ Pressure Wash (2500-3000)

Formerly - PowerClean® 1 or 2 Wire Braid



#### Pressure Wash 2500

Color	Hose I.D.		Hose O.D.		Max. W.P.	Vac.	MBR	Wt. Per ft	Length	Std. Pack	Pkg Code	Stock or MTO	Gates Item No.	List Price Per ft	
	(in)	(mm)	(in)	(mm)											(psi)
Black	1/2	12.7	.80	20.3	2500	172.4	30.0	3.5	.28	300	Reel	S	Stock	4657-2408	\$4.13
Black	1/2	12.7	.80	20.3	2500	172.4	30.0	3.5	.28	1000	Reel	S	MTO	4657-2412	3.96
Blue	1/2	12.7	.80	20.3	2500	172.4	30.0	3.5	.28	300	Reel	S	Stock	4657-2413	4.34
Gray	1/2	12.7	.80	20.3	2500	172.4	30.0	3.5	.28	300	Reel	S	Stock	4657-2414	4.34
Yellow	1/2	12.7	.80	20.3	2500	172.4	30.0	3.5	.28	300	Reel	S	Stock	4657-2415	4.34

#### Pressure Wash 3000

Color	Hose I.D.		Hose O.D.		Max. W.P.	Vac.	MBR	Wt. Per ft	Length	Std. Pack	Pkg Code	Stock or MTO	Gates Item No.	List Price Per ft	
	(in)	(mm)	(in)	(mm)											(psi)
Black	3/8	9.5	.68	17.3	3000	206.8	30.0	2.5	.23	300	Reel	S	Stock	4657-2402	\$3.60
Black	3/8	9.5	.68	17.3	3000	206.8	30.0	2.5	.23	1000	Reel	S	Stock	4657-2401	3.47
Blue	3/8	9.5	.68	17.3	3000	206.8	30.0	2.5	.23	300	Reel	S	Stock	4657-2404	3.78
Blue	3/8	9.5	.68	17.3	3000	206.8	30.0	2.5	.23	1000	Reel	S	Stock	4657-2403	3.65
Gray	3/8	9.5	.68	17.3	3000	206.8	30.0	2.5	.23	300	Reel	S	Stock	4657-2416	3.78
Yellow	3/8	9.5	.68	17.3	3000	206.8	30.0	2.5	.23	300	Reel	S	Stock	4657-2417	3.78
Yellow	3/8	9.5	.68	17.3	3000	206.8	30.0	2.5	.24	1000	Reel	S	MTO	4657-2652	3.65

**RECOMMENDED FOR:** Hot and cold water high-pressure cleaning equipment where heavy-duty service is required. Specially compounded cover to handle pressure washer environment.

**CAUTION:** Not recommended for steam service. Use bend restrictors to extend service life.

**TEMPERATURE:** -40°F to +250°F (-40°C to +121°C). Laboratory tested for normal service. Increased operating temperatures will reduce hose assembly service life.

**CONSTRUCTION:** **Tube:** Type C (Nitrile). Black.  
**Reinforcement:** Braided, high tensile steel wire.  
**Cover:** Type C2 (Modified Nitrile). Non-marking except for black.

**COUPLINGS:** 74 Gates MegaCrimp® couplings. Reference the Hose Coupling Section.

**STANDARDS:** Exceeds EN1829-2.

AGRICULTURE
AIR BREATHING
AIR DUCT
AIR AND MULTI-PURPOSE
CHEMICAL
FOOD AND BEVERAGE
MARINE AND ENGINE
MATERIAL HANDLING
MINING
OILFIELD
PETROLEUM
PRESSURE WASH AND WASHDOWN
STEAM
WATER
CLAMPS
COUPLINGS AND FERRULES
HOSE FINDER
CHEMICAL RESISTANCE TABLE

## Pressure Wash and Washdown Hose

### Clean Master™ Pressure Wash (3500-4000)

Formerly - PowerClean® 1 or 2 Wire Braid



#### Pressure Wash 3500

Color	Hose I.D.		Hose O.D.		Max. W.P.		Vac.	MBR	Wt. Per ft	Length	Std. Pack	Pkg Code	Stock or MTO	Gates Item No.	List Price Per ft
	(in)		(mm)		(in)								(mm)		
Black	1/4	6.4	.53	13.5	3500	241.3	30.0	2.0	.15	300	Reel	S	Stock	4657-2400	\$3.00
Black	1/4	6.4	.53	13.5	3500	241.3	30.0	2.0	.15	1000	Reel	S	Stock	4657-2418	2.88
Blue	1/4	6.4	.53	13.5	3500	241.3	30.0	2.0	.15	300	Reel	S	Stock	4657-2419	3.15
Blue	1/4	6.4	.53	13.5	3500	241.3	30.0	2.0	.17	1000	Reel	S	MTO	4657-2562	3.05
Gray	1/4	6.4	.53	13.5	3500	241.3	30.0	2.0	.15	300	Reel	S	Stock	4657-2420	3.15
Yellow	1/4	6.4	.53	13.5	3500	241.3	30.0	2.0	.15	300	Reel	S	MTO	4657-2421	3.15

#### Pressure Wash 4000

Color	Hose I.D.		Hose O.D.		Max. W.P.		Vac.	MBR	Wt. Per ft	Length	Std. Pack	Pkg Code	Stock or MTO	Gates Item No.	List Price Per ft
	(in)		(mm)		(in)								(mm)		
Black	3/8	9.5	.68	17.3	4000	275.8	30.0	2.5	.23	300	Reel	S	Stock	4657-2225	\$4.34
Black	3/8	9.5	.68	17.3	4000	275.8	30.0	2.5	.23	1000	Reel	S	Stock	4657-2405	4.17
Blue	3/8	9.5	.68	17.3	4000	275.8	30.0	2.5	.23	300	Reel	S	Stock	4657-2422	4.55
Gray	3/8	9.5	.68	17.3	4000	275.8	30.0	2.5	.23	300	Reel	S	Stock	4657-2423	4.55
Gray	3/8	9.5	.68	17.3	4000	275.8	30.0	2.5	.25	1000	Reel	S	MTO	4657-2156	4.55
Red	3/8	9.5	.68	17.3	4000	275.8	30.0	2.5	.25	1000	Reel	S	MTO	4657-2499	4.55
Yellow	3/8	9.5	.68	17.3	4000	275.8	30.0	2.5	.23	300	Reel	S	MTO	4657-2424	4.55

**RECOMMENDED FOR:** Hot and cold water high-pressure cleaning equipment where heavy-duty service is required. Specially compounded cover to handle pressure washer environment.

**CAUTION:** Not recommended for steam service. Use bend restrictors to extend service life.

**TEMPERATURE:** -40°F to +250°F (-40°C to +121°C). Laboratory tested for normal service. Increased operating temperatures will reduce hose assembly service life.

**CONSTRUCTION:** **Tube:** Type C (Nitrile). Black.  
**Reinforcement:** Braided, high tensile steel wire.  
**Cover:** Type C2 (Modified Nitrile). Non-marking except for black.

**COUPLINGS:** 74 Gates MegaCrimp® couplings. Reference the Hose Coupling Section.

**STANDARDS:** Exceeds EN1829-2.

AGRICULTURE

AIR BREATHING

AIR DUCT

AIR AND MULTI-PURPOSE

CHEMICAL

FOOD AND BEVERAGE

MARINE AND ENGINE

MATERIAL HANDLING

MINING

OILFIELD

PETROLEUM

PRESSURE WASH AND WASHDOWN

STEAM

WATER

CLAMPS

COUPLINGS AND FERRULES

HOSE FINDER

CHEMICAL RESISTANCE TABLE

## Pressure Wash and Washdown Hose

### Clean Master™ Pressure Wash (4000-6000)

Formerly - PowerClean® 1 or 2 Wire Braid



#### Pressure Wash 4000

Color	Hose I.D.		Hose O.D.		Max. W.P.	Vac.	MBR	Wt. Per ft	Length	Std. Pack	Pkg Code	Stock or MTO	Gates Item No.	List Price Per ft	
	(in)	(mm)	(in)	(mm)											(psi)
Black	1/2	12.7	.86	21.8	4000	275.8	30.0	3.5	.42	300	Reel	S	Stock	4657-2426	\$5.75
Black	1/2	12.7	.86	21.8	4000	275.8	30.0	3.5	.42	1000	Reel	S	MTO	4657-2425	5.52
Blue	1/2	12.7	.86	21.8	4000	275.8	30.0	3.5	.42	300	Reel	S	MTO	4657-2409	6.03
Gray	1/2	12.7	.86	21.8	4000	275.8	30.0	3.5	.42	300	Reel	S	MTO	4657-2427	6.03
Yellow	1/2	12.7	.86	21.8	4000	275.8	30.0	3.5	.42	300	Reel	S	MTO	4657-2428	6.03

#### Pressure Wash 5000

Color	Hose I.D.		Hose O.D.		Max. W.P.	Vac.	MBR	Wt. Per ft	Length	Std. Pack	Pkg Code	Stock or MTO	Gates Item No.	List Price Per ft	
	(in)	(mm)	(in)	(mm)											(psi)
Black	3/8	9.5	.74	18.8	5000	344.7	30.0	2.5	.35	300	Reel	S	Stock	4657-2407	\$5.07
Black	3/8	9.5	.74	18.8	5000	344.7	30.0	2.5	.35	1000	Reel	S	Stock	4657-2406	4.88
Blue	3/8	9.5	.74	18.8	5000	344.7	30.0	2.5	.35	300	Reel	S	Stock	4657-2429	5.33
Gray	3/8	9.5	.74	18.8	5000	344.7	30.0	2.5	.35	300	Reel	S	MTO	4657-2430	5.33
Yellow	3/8	9.5	.74	18.8	5000	344.7	30.0	2.5	.35	300	Reel	S	MTO	4657-2431	5.33

#### Pressure Wash 6000

Color	Hose I.D.		Hose O.D.		Max. W.P.	Vac.	MBR	Wt. Per ft	Length	Std. Pack	Pkg Code	Stock or MTO	Gates Item No.	List Price Per ft	
	(in)	(mm)	(in)	(mm)											(psi)
Black	1/4	6.4	.59	15.0	6000	413.7	30.0	2.0	.25	300	Reel	S	Stock	4657-2410	\$4.11

**RECOMMENDED FOR:** Hot and cold water high-pressure cleaning equipment where heavy-duty service is required. Specially compounded cover to handle pressure washer environment.

**CAUTION:** Not recommended for steam service. Use bend restrictors to extend service life.

**TEMPERATURE:** -40°F to +250°F (-40°C to +121°C). Laboratory tested for normal service. Increased operating temperatures will reduce hose assembly service life.

**CONSTRUCTION:**  
**Tube:** Type C (Nitrile). Black.  
**Reinforcement:** Braided, high tensile steel wire.  
**Cover:** Type C2 (Modified Nitrile). Non-marking except for black.

**COUPLINGS:** 74 Gates MegaCrimp® couplings. Reference the Hose Coupling Section.

**STANDARDS:** Exceeds EN1829-2.

AGRICULTURE
AIR BREATHING
AIR DUCT
AIR AND MULTI-PURPOSE
CHEMICAL
FOOD AND BEVERAGE
MARINE AND ENGINE
MATERIAL HANDLING
MINING
OILFIELD
PETROLEUM
PRESSURE WASH AND WASHDOWN
STEAM
WATER
CLAMPS
COUPLINGS AND FERRULES
HOSE FINDER
CHEMICAL RESISTANCE TABLE

## Pressure Wash and Washdown Hose

### Clean Master™ Pressure Wash Assemblies



Color	Hose I.D.		Hose O.D.		Max. W.P.		Vac.	MBR	Wt. Per ea	Length	Std. Pack	Pkg Code	Stock or MTO	Gates Item No.	List Price Per ea
	(in)		(mm)		(in)				(mm)				(psi)		
Black	1/4	6.4	.48	12.2	3000	206.8	30.0	2.0	5.80	50	Assy	5	MTO	3604-0034	\$171.87
Black	3/8	9.5	.63	16.0	3000	206.8	30.0	2.5	11.00	50	Assy	5	Stock	3604-0035	191.73
Black	3/8	9.5	.63	16.0	3000	206.8	30.0	2.5	19.40	100	Assy	5	Stock	3604-0071	291.98
Black	1/2	12.7	.76	19.3	3000	206.8	30.0	3.5	12.98	50	Assy	5	Stock	3604-0036	222.18

**RECOMMENDED FOR:** Standard-duty use on hot and cold water high-pressure cleaning equipment. Extremely flexible, lightweight and easy to handle. Tube specially compounded to handle high-pressure water service. Specially compounded cover to handle pressure washer environment.

**CAUTION:** Not recommended for steam service.

**TEMPERATURE:** -40°F to +250°F (-40°C to +121°C). Laboratory tested for normal service. Increased operating temperatures will reduce hose assembly service life.

**CONSTRUCTION:**  
**Tube:** Type C (Nitrile). Black.  
**Reinforcement:** Braided, high tensile steel wire.  
**Cover:** Type C2 (Modified Nitrile). Black.

**COUPLINGS:** Gates permanent couplings (MP/MPX with bend restrictors applied on each end). Factory coupled assemblies only.

**STANDARDS:** Exceeds EN1829-2.

AGRICULTURE

AIR BREATHING

AIR DUCT

AIR AND MULTI-PURPOSE

CHEMICAL

FOOD AND BEVERAGE

MARINE AND ENGINE

MATERIAL HANDLING

MINING

OILFIELD

PETROLEUM

PRESSURE WASH AND WASHDOWN

STEAM

WATER

CLAMPS

COUPLINGS AND FERRULES

HOSE FINDER

CHEMICAL RESISTANCE TABLE



## Pressure Wash and Washdown Hose

### Clean Master™ Washdown 1000 Formerly - Cyclone®



AGRICULTURE
AIR BREATHING
AIR DUCT
AIR AND MULTI-PURPOSE
CHEMICAL
FOOD AND BEVERAGE
MARINE AND ENGINE
MATERIAL HANDLING
MINING
OILFIELD
PETROLEUM
PRESSURE WASH AND WASHDOWN
STEAM
WATER
CLAMPS
COUPLINGS AND FERRULES
HOSE FINDER
CHEMICAL RESISTANCE TABLE

Color	Hose I.D.	Hose O.D.	Max. W.P.	Vac.	MBR	Wt. Per ft	Length	Std. Pack	Pkg Code	Stock or MTO	Gates Item No.	List Price Per ft			
	(in)	(mm)											(in)	(mm)	(psi)
Yellow	3/8	9.5	.73	18.5	1000	68.9	30.0	4.0	.18	100	Bulk	500	Stock	3217-0584	\$6.35
Yellow	3/8	9.5	.73	18.5	1000	68.9	30.0	4.0	.18	625	Reel	BB	Stock	3217-0585	5.63
Yellow	1/2	12.7	.94	23.9	1000	68.9	30.0	5.0	.29	100	Bulk	500	MTO	3217-0587	8.82
Yellow	1/2	12.7	.94	23.9	1000	68.9	30.0	5.0	.29	625	Reel	BB	Stock	3217-0586	7.80
Yellow	3/4	19.1	1.20	30.5	1000	68.9	30.0	6.0	.41	625	Reel	BB	Stock	3217-0588	12.38

**RECOMMENDED FOR:** High-pressure washer operations using mild detergents; ideal for meat, poultry and other food processing plants. Cover is resistant to weather, oil, animal fat, abrasion and heat encountered in food plant cleaning applications.

**CAUTION:** Air service working pressure is 300 psi for all sizes.

**TEMPERATURE:** -40°F to +212°F (-40°C to +100°C) continuous washdown service.

**CONSTRUCTION:**  
**Tube:** Type C2 (Modified Nitrile). Black.  
**Reinforcement:** Braided, synthetic high tensile cord.  
**Cover:** Type C2 (Modified Nitrile). Yellow. Red, gray and blue cover available on special order. All colors non-marking.

**Design Factor:** 4:1

**COUPLINGS:** 75 Gates GLX®. Reference the Hose Coupling Section.

## Pressure Wash and Washdown Hose

### Clean Master™ Washdown

Formerly - Creamery/Paper Mill Washdown



#### Without Nozzle

Color	Hose I.D.		Hose O.D.		Max. W.P.		Vac.	MBR	Wt. Per ft	Length	Std. Pack	Pkg Code	Stock or MTO	Gates Item No.	List Price Per ft
	(in)	(mm)	(in)	(mm)	(psi)	(Bar)									
White	1/2	12.7	.91	23.1	200	13.8	25.0	5.0	.28	700	Reel	FF	Stock	3213-0401	\$4.10
White	3/4	19.1	1.25	31.8	200	13.8	15.0	6.0	.49	50	Ctn	T	Stock	3213-0413	5.87
White	3/4	19.1	1.25	31.8	200	13.8	15.0	6.0	.49	350	Reel	KK	Stock	3213-0501	5.87
White	1	25.4	1.52	38.6	200	13.8	15.0	8.0	.65	50	Ctn	T	MTO	3213-0416	8.45
White	1	25.4	1.52	38.6	200	13.8	15.0	8.0	.65	350	Reel	KK	MTO	3213-0415	8.45

#### Exact Length 500 Foot One Piece Reels

Color	Hose I.D.		Hose O.D.		Max. W.P.		Vac.	MBR	Wt. Per ft	Length	Std. Pack	Pkg Code	Stock or MTO	Gates Item No.	List Price Per ft
	(in)	(mm)	(in)	(mm)	(psi)	(Bar)									
White	1/2	12.7	.91	23.1	200	13.8	25.0	5.0	.28	500	Reel	T	Stock	3213-0451	\$4.51
White	3/4	19.1	1.25	31.8	200	13.8	15.0	6.0	.51	500	Reel	T	Stock	3213-0551	6.46

#### With Nozzle

Color	Hose I.D.		Hose O.D.		Max. W.P.		Vac.	MBR	Wt. Per ea	Length	Std. Pack	Pkg Code	Stock or MTO	Gates Item No.	List Price Per ea
	(in)	(mm)	(in)	(mm)	(psi)	(Bar)									
Gray	3/4	19.1	1.25	31.8	150	10.3	25.0	6.0	27.50	50	PLT	T	Stock	3213-0543	\$565.53
Gray	1	25.4	1.50	38.1	150	10.3	15.0	8.0	33.50	50	PLT	T	Stock	3213-0544	633.62
Gray	1 1/4	31.8	1.75	44.5	150	10.3	15.0	10.0	39.50	50	PLT	T	Stock	3213-0545	709.37

**RECOMMENDED FOR:** Cold and hot water up to +212°F (+100°C) where steam is injected into the water. Used for paper mill, food handling or processing plant washdown service requiring hose with a non-marking cover.

**CAUTION:** Not recommended for use with steam.

**TEMPERATURE:** -20°F to +180°F (-29°C to +82°C) continuous service. For nozzle only.  
-40°F to +212°F (-40°C to +100°C) continuous service.

**CONSTRUCTION:** **Tube:** Type D (SBR). Black. For nozzle only.  
Type P (EPDM). Black.  
**Reinforcement:** Braided, high tensile synthetic textile cord. For nozzle only.  
Synthetic, high tensile textile cord.  
**Cover:** Type D (Natural Rubber). Gray with green stripe. For nozzle only.  
Type P (EPDM). White. All sizes are perforated on plain end hose only.  
**Design Factor:** 4:1

**COUPLINGS:** 1, 14, 15 or 75 Gates GLX® (For without nozzle only) or 82 Gates SS (for without nozzle only). Reference the Hose Coupling Section.

AGRICULTURE

AIR BREATHING

AIR DUCT

AIR AND MULTI-PURPOSE

CHEMICAL

FOOD AND BEVERAGE

MARINE AND ENGINE

MATERIAL HANDLING

MINING

OILFIELD

PETROLEUM

PRESSURE WASH AND WASHDOWN

STEAM

WATER

CLAMPS

COUPLINGS AND FERRULES

HOSE FINDER

CHEMICAL RESISTANCE TABLE

## Steam Hose

### Plant Master® Steam 250 Formerly - 205MB Steam King®



#### Smooth Cover

Color	Hose I.D.		Hose O.D.		Max. W.P.		Vac.	MBR	Wt. Per ft	Length	Std. Pack	Pkg Code	Stock or MTO	Gates Item No.	List Price Per ft
	(in)	(mm)	(in)	(mm)	(psi)	(Bar)	(In. Hg)	(in)	(Lbs.)	(ft)			(ft)		
Black	3/8	9.5	.78	19.8	250	17.2	30.0	4.0	.26	50	Bulk	250	Stock	3605-0650	\$7.92
Black	3/8	9.5	.78	19.8	250	17.2	30.0	4.0	.26	250	Reel	LL	Stock	3605-0652	7.92
Black	1/2	12.7	1.06	26.9	250	17.2	25.0	7.0	.40	50	Bulk	200	Stock	3605-0655	9.65
Black	1/2	12.7	1.06	26.9	250	17.2	25.0	7.0	.40	50	Bulk	1500	Stock	3605-0677	9.15
Black	1/2	12.7	1.06	26.9	250	17.2	25.0	7.0	.40	500	Reel	VV	Stock	3605-0672	9.65
Black	3/4	19.1	1.28	32.5	250	17.2	20.0	9.0	.49	50	Bulk	150	Stock	3605-0664	11.22
Black	3/4	19.1	1.28	32.5	250	17.2	20.0	9.0	.49	50	Bulk	1000	Stock	3605-0679	10.67
Black	3/4	19.1	1.28	32.5	250	17.2	20.0	9.0	.49	500	Reel	VV	Stock	3605-0678	11.22
Black	1	25.4	1.63	41.4	250	17.2	20.0	11.0	.78	500	Reel	VV	Stock	3605-0668	16.28

#### Wrapped Cover

Color	Hose I.D.		Hose O.D.		Max. W.P.		Vac.	MBR	Wt. Per ft	Length	Std. Pack	Pkg Code	Stock or MTO	Gates Item No.	List Price Per ft
	(in)	(mm)	(in)	(mm)	(psi)	(Bar)	(In. Hg)	(in)	(Lbs.)	(ft)			(ft)		
Black	3/4	19.1	1.27	32.3	250	17.2	20.0	9.0	.57	50	Bulk	100	Stock	3605-0901	\$11.22
Black	1	25.4	1.52	38.6	250	17.2	20.0	11.0	.70	50	Bulk	200	Stock	3605-0665	16.28
Black	1	25.4	1.52	38.6	250	17.2	20.0	11.0	.70	50	Bulk	600	Stock	3605-0669	15.51
Black	1 1/4	31.8	1.81	46.0	250	17.2	20.0	16.0	.90	50	Ctn	T	Stock	3605-0671	23.42
Black	1 1/2	38.1	2.14	54.4	250	17.2	10.0	20.0	1.21	50	Ctn	T	Stock	3605-0676	29.52
Black	2	50.8	2.66	67.6	250	17.2	10.0	25.0	1.57	50	Ctn	T	Stock	3605-0681	35.31

#### Assemblies - Wrapped Cover

Color	Hose I.D.		Hose O.D.		Max. W.P.		Vac.	MBR	Wt. Per ea	Length	Std. Pack	Pkg Code	Stock or MTO	Gates Item No.	List Price Per ea
	(in)	(mm)	(in)	(mm)	(psi)	(Bar)	(In. Hg)	(in)	(Lbs.)	(ea)			(ea)		
Black	3/4	19.1	1.27	32.3	250	17.2	20.0	9.0	31.90	50 ft. F/F	Assy	T	Stock	3605-0736	\$642.05
Black	3/4	19.1	1.27	32.3	250	17.2	20.0	9.0	30.90	50 ft. F/M	Assy	T	Stock	3605-0737	603.36
Black	3/4	19.1	1.27	32.3	250	17.2	20.0	9.0	29.90	50 ft. M/M	Assy	T	Stock	3605-0738	564.66

**RECOMMENDED FOR:** All types of steam – saturated and superheated – up to 250 PSI and +450°F (+232°C).

**CAUTION:** Do not alternate use between steam and water.

**TEMPERATURE:** -40°F to +450°F (-40°C to +232°C) continuous service.

**CONSTRUCTION:**  
**Tube:** Type P2 (EPDM). Black.  
**Reinforcement:** Braided, high tensile steel wire.  
**Cover:** Type P2 (EPDM). Black with red stripe. All sizes are perforated.  
**Design Factor:** 10:1

**COUPLINGS:** 14, 15 or 76 only. Reference the Hose Coupling Section.

# Steam Hose

## Plant Master® Steam Plus 250

Formerly - 232MB Steam Queen®

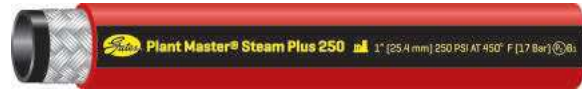

### Wrapped Cover

Color	Hose I.D.		Hose O.D.		Max. W.P.	Vac.	MBR	Wt. Per ft	Length	Std. Pack	Pkg Code	Stock or MTO	Gates Item No.	List Price Per ft	
	(in)	(mm)	(in)	(mm)											(psi)
Red	3/8	9.5	.80	20.3	250	17.2	30.0	4.0	.32	50	Ctn	T	Stock	3602-1051	\$8.24
Red	3/8	9.5	.80	20.3	250	17.2	30.0	4.0	.30	250	Reel	LL	Stock	3602-1061	8.24
Red	1/2	12.7	1.02	25.9	250	17.2	25.0	7.0	.45	50	Ctn	T	Stock	3602-1052	10.31
Red	1/2	12.7	1.02	25.9	250	17.2	25.0	7.0	.45	250	Reel	LL	Stock	3602-1062	10.31
Red	3/4	19.1	1.27	32.3	250	17.2	20.0	9.0	.60	50	Ctn	T	Stock	3602-1055	13.29
Red	3/4	19.1	1.27	32.3	250	17.2	20.0	9.0	.60	250	Reel	LL	Stock	3602-1065	13.29
Red	1	25.4	1.52	38.6	250	17.2	20.0	11.0	.73	50	Ctn	T	Stock	3602-1057	16.91
Red	1 1/2	38.1	2.18	55.4	250	17.2	10.0	20.0	1.24	50	Ctn	T	Stock	3602-1059	33.30
Red	2	50.8	2.66	67.6	250	17.2	10.0	25.0	1.80	50	Ctn	T	Stock	3602-1060	40.19

### Assemblies - Wrapped Cover

Color	Hose I.D.		Hose O.D.		Max. W.P.	Vac.	MBR	Wt. Per ea	Length	Std. Pack	Pkg Code	Stock or MTO	Gates Item No.	List Price Per ea	
	(in)	(mm)	(in)	(mm)											(psi)
Red	3/4	19.1	1.27	32.3	250	17.2	20.0	9.0	33.40	50 ft. F/F	Assy	T	Stock	3602-0002	\$769.23
Red	3/4	19.1	1.27	32.3	250	17.2	20.0	9.0	31.40	50 ft. M/M	Assy	T	Stock	3602-0004	691.85

**RECOMMENDED FOR:** All types of steam – saturated and superheated – up to 250 PSI and +450°F (+232°C). Special compound cover for use in refineries and processing plants.

**CAUTION:** Do not alternate use between steam and water.

**TEMPERATURE:** -40°F to +450°F (-40°C to +232°C) continuous service.

**CONSTRUCTION:**  
**Tube:** Type P2 (EPDM). Black.  
**Reinforcement:** Braided, high tensile steel wire.  
**Cover:** Type B1 (Special compound designed to withstand heat and oil). Red with black stripe. All sizes are perforated.  
**Design Factor:** 10:1

**COUPLINGS:** 14, 15 or 76 only. Reference the Hose Coupling Section.

AGRICULTURE

AIR BREATHING

AIR DUCT

AIR AND MULTI-PURPOSE

CHEMICAL

FOOD AND BEVERAGE

MARINE AND ENGINE

MATERIAL HANDLING

MINING

OILFIELD

PETROLEUM

PRESSURE WASH AND WASHDOWN

STEAM

WATER

CLAMPS

COUPLINGS AND FERRULES

HOSE FINDER

CHEMICAL RESISTANCE TABLE

## Water Hose

### Water Master® (100-150) SD AR

Formerly - Shark®



AGRICULTURE
AIR BREATHING
AIR DUCT
AIR AND MULTI-PURPOSE
CHEMICAL
FOOD AND BEVERAGE
MARINE AND ENGINE
MATERIAL HANDLING
MINING
OILFIELD
PETROLEUM
PRESSURE WASH AND WASHDOWN
STEAM
WATER
CLAMPS
COUPLINGS AND FERRULES
HOSE FINDER
CHEMICAL RESISTANCE TABLE

Color	Hose I.D.	Hose O.D.	Max. W.P.	Vac.	MBR	Wt. Per ft	Length	Std. Pack	Pkg Code	Stock or MTO	Gates Item No.	List Price Per ft			
	(in)	(mm)											(psi)	(Bar)	(In. Hg)
Black	1	25.4	1.45	36.8	150	10.3	30.0	5.0	.53	100	PLT	T	Stock	4686-0701	\$12.80
Black	1 1/4	31.8	1.71	43.4	150	10.3	30.0	6.0	.68	100	PLT	T	MTO	4686-0702	14.13
Black	1 1/2	38.1	1.96	49.8	150	10.3	30.0	8.0	.79	100	PLT	T	Stock	4686-0703	15.42
Black	2	50.8	2.46	62.5	150	10.3	30.0	10.0	.99	100	PLT	T	Stock	4686-0704	18.30
Black	2	50.8	2.46	62.5	150	10.3	30.0	10.0	.99	200	PLT	T	MTO	4686-0710	18.30
Black	2 1/2	63.5	3.02	76.7	150	10.3	30.0	12.0	1.44	100	PLT	T	Stock	4686-0705	23.91
Black	3	76.2	3.58	90.9	150	10.3	30.0	15.0	1.90	100	PLT	T	Stock	4686-0706	27.95
Black	4	101.6	4.58	116.3	150	10.3	30.0	20.0	2.48	100	PLT	T	Stock	4686-0707	39.72
Black	5	127.0	5.60	142.2	100	6.9	30.0	25.0	3.62	100	PLT	T	Stock	4686-0708	61.85
Black	6	152.4	6.65	168.9	100	6.9	30.0	30.0	4.84	20	PLT	T	Stock	4686-0711	78.36
Black	6	152.4	6.65	168.9	100	6.9	30.0	30.0	4.84	25	PLT	T	MTO	4686-0712	78.36
Black	6	152.4	6.65	168.9	100	6.9	30.0	30.0	4.84	100	PLT	T	Stock	4686-0709	78.36

**RECOMMENDED FOR:** Suction hose used to convey water, detergents, phosphate ester hydraulic fluids and dilute solutions of acids, alkalies and glycols.

**TEMPERATURE:** -40°F to +180°F (-40°C to +82°C) continuous service.

**CONSTRUCTION:**  
**Tube:** Type P (EPDM). Black.  
**Reinforcement:** Synthetic, high tensile textile with steel wire helix.  
**Cover:** Type D (SBR). Black with blue stripe. Abrasion-resistant.  
**Design Factor:** 3:1

**COUPLINGS:** 6, 7, 49 or 78. Reference the Hose Coupling Section.

## Water Hose

### Water Master® (100-150) SD

Formerly - Barracuda®



#### Smooth Cover

Color	Hose I.D.		Hose O.D.		Max. W.P.		Vac.	MBR	Wt. Per ft	Length	Std. Pack	Pkg Code	Stock or MTO (ft)	Gates Item No.	List Price Per ft
	(in)	(mm)	(in)	(mm)	(psi)	(Bar)									
Black	1	25.4	1.33	33.8	150	10.3	30.0	5.0	.39	100	PLT	T	MTO	4686-0199	\$8.25
Black	1 1/4	31.8	1.61	40.9	150	10.3	30.0	5.0	.51	100	100	T	Stock	4686-0203	9.00
Black	1 1/2	38.1	1.86	47.2	150	10.3	30.0	6.0	.60	100	100	T	Stock	4686-0204	10.88
Black	1 1/2	38.1	1.86	47.2	150	10.3	30.0	6.0	.60	200	PLT	T	MTO	4686-0237	10.88
Black	2	50.8	2.36	59.9	150	10.3	30.0	8.0	.76	100	100	T	Stock	4686-0200	12.60
Black	2	50.8	2.36	59.9	150	10.3	30.0	8.0	.76	200	PLT	T	MTO	4686-0235	12.60
Black	2 1/2	63.5	2.96	75.2	150	10.3	30.0	10.0	1.06	100	100	T	Stock	4686-0205	15.60
Black	2 1/2	63.5	2.96	75.2	150	10.3	30.0	10.0	1.06	200	PLT	T	MTO	4686-0250	15.60
Black	3	76.2	3.54	89.9	150	10.3	30.0	14.0	1.44	100	100	T	Stock	4686-0201	17.40
Black	3	76.2	3.54	89.9	150	10.3	30.0	14.0	1.44	200	PLT	T	MTO	4686-0236	17.40
Black	4	101.6	4.54	115.3	150	10.3	30.0	18.0	2.25	100	100	T	Stock	4686-0202	24.75
Black	4	101.6	4.54	115.3	150	10.3	30.0	18.0	2.25	200	PLT	T	MTO	4686-0208	24.75
Black	6	152.4	6.68	169.7	100	6.9	30.0	28.0	3.94	20	PLT	T	Stock	4686-0207	64.73
Black	6	152.4	6.68	169.7	100	6.9	30.0	28.0	3.94	25	PLT	T	Stock	4686-0206	64.73
Black	6	152.4	6.68	169.7	100	6.9	30.0	28.0	3.94	100	PLT	T	MTO	4686-0234	64.73
Black	8	203.2	9.00	228.6	100	6.9	30.0	40.0	9.00	20	STRT	T	MTO	4686-0212	165.30
Black	8	203.2	9.00	228.6	100	6.9	30.0	40.0	8.68	25	STRT	T	MTO	4686-0209	165.30
Black	10	254.0	11.27	286.3	100	6.9	30.0	50.0	15.80	20	STRT	T	MTO	4686-0213	268.94
Black	10	254.0	11.27	286.3	100	6.9	30.0	50.0	15.80	25	STRT	T	MTO	4686-0210	268.94
Black	12	304.8	13.27	337.1	100	6.9	30.0	60.0	18.63	20	STRT	T	MTO	4686-0214	307.61
Black	12	304.8	13.27	337.1	100	6.9	30.0	60.0	17.60	25	STRT	T	MTO	4686-0211	307.61

#### Corrugated Cover

Color	Hose I.D.		Hose O.D.		Max. W.P.		Vac.	MBR	Wt. Per ft	Length	Std. Pack	Pkg Code	Stock or MTO (ft)	Gates Item No.	List Price Per ft
	(in)	(mm)	(in)	(mm)	(psi)	(Bar)									
Black	4	101.6	4.54	115.3	150	10.3	30.0	16.0	4.36	100	PLT	T	Stock	4686-0074	\$27.23
Black	6	152.4	6.68	169.7	100	6.9	30.0	26.0	2.55	100	PLT	T	Stock	4686-0075	71.20

**RECOMMENDED FOR:** Medium to light-duty water suction/discharge for agricultural, construction and industrial applications. The EPDM tube is specially compounded to handle mild chemicals and a variety of solutions including Lasso\*, Lasso II\* and Freedom\*. (\*Registered Trademarks of Monsanto)

**TEMPERATURE:** -32°F to +200°F (-36°C to +93°C). For 8" through 12" sizes.  
-40°F to +180°F (-40°C to +82°C). For 1" through 6" sizes.

**CONSTRUCTION:** **Tube:** Type P (EPDM). Black.  
**Reinforcement:** Synthetic, high tensile textile with steel wire helix.  
**Cover:** Type P (EPDM). Black with blue stripe. Sizes 8" through 12" are corrugated.  
**Design Factor:** 3:1

**COUPLINGS:** 5, 6, 7, 8, 49 or 78 all sizes. Reference the Hose Coupling Section.

AGRICULTURE

AIR BREATHING

AIR DUCT

AIR AND MULTI-PURPOSE

CHEMICAL

FOOD AND BEVERAGE

MARINE AND ENGINE

MATERIAL HANDLING

MINING

OILFIELD

PETROLEUM

PRESSURE WASH AND WASHDOWN

STEAM

WATER

CLAMPS

COUPLINGS AND FERRULES

HOSE FINDER

CHEMICAL RESISTANCE TABLE

## Water Master® Water Suction/Discharge 150SD



AGRICULTURE
AIR BREATHING
AIR DUCT
AIR AND MULTI-PURPOSE
CHEMICAL
FOOD AND BEVERAGE
MARINE AND ENGINE
MATERIAL HANDLING
MINING
OILFIELD
PETROLEUM
PRESSURE WASH AND WASHDOWN
STEAM
WATER
CLAMPS
COUPLINGS AND FERRULES
HOSE FINDER
CHEMICAL RESISTANCE TABLE

Color	Hose I.D.		Hose O.D.		Max. W.P.		Vac.	MBR	Wt. Per ft	Length	Std. Pack	Pkg Code	Stock or MTO	Gates Item No.	List Price Per ft
	(in)	(mm)	(in)	(mm)	(psi)	(Bar)									
Black	2	50.8	2.36	59.9	150	10.3	30.0	8.0	1.08	100	PLT	T	Stock	4686-0751	\$10.08
Black	3	76.2	3.54	89.9	150	10.3	30.0	14.0	2.10	100	PLT	T	Stock	4686-0752	13.92
Black	4	101.6	4.54	115.3	150	10.3	30.0	18.0	2.37	100	PLT	T	MTO	4686-0753	19.80

NOTE: Made in Mexico.

**RECOMMENDED FOR:** Economical, medium to light-duty water suction/discharge for agricultural, construction and industrial applications. EPDM tube designed to handle a variety of liquids including Lasso®\*, Lasso II®\* and Freedom®\*. Recommended for sanitation liner in marine applications. (\*Registered Trademarks of Monsanto)

**TEMPERATURE:** -40°F to +180°F (-40°C to +82°C).

**CONSTRUCTION:** **Tube:** Type P (EPDM). Black.  
**Reinforcement:** Synthetic, high tensile textile cord with steel wire helix.  
**Cover:** Type P (EPDM). Black with blue stripe.  
**Design Factor:** 3:1

**COUPLINGS:** 5, 6, 7, 8, 49 or 78 all sizes. Reference the Hose Coupling Section.

## Water Hose

### Water Master® Slurry 150D AR

Formerly - Steelhead®



Color	Hose I.D.		Hose O.D.		Max. W.P.		Vac.	MBR	Wt. Per ft	Length	Std. Pack	Pkg Code	Stock or MTO	Gates Item No.	List Price Per ft
	(in)	(mm)	(in)	(mm)	(psi)	(Bar)									
Black	1 1/2	38.1	1.98	50.3	150	10.3	—	12.0	.70	100	PLT	T	Stock	3135-2651	\$16.62
Black	1 5/8	41.3	2.10	53.3	150	10.3	—	15.0	.74	100	PLT	T	MTO	3135-2652	17.33
Black	1 7/8	47.6	2.35	59.7	150	10.3	—	15.0	.88	100	PLT	T	MTO	3135-2653	18.80
Black	2	50.8	2.48	63.0	150	10.3	—	20.0	.93	100	PLT	T	Stock	3135-2654	19.82
Black	2 1/2	63.5	2.99	75.9	150	10.3	—	25.0	1.14	100	PLT	T	Stock	3135-2655	24.75
Black	3	76.2	3.49	88.6	150	10.3	—	36.0	1.37	100	PLT	T	Stock	3135-2656	30.93
Black	3	76.2	3.49	88.6	150	10.3	—	36.0	1.37	200	PLT	T	MTO	3135-2661	30.93
Black	3 1/2	88.9	3.99	101.3	150	10.3	—	42.0	1.60	100	PLT	T	MTO	3135-2657	31.77
Black	4	101.6	4.49	114.0	150	10.3	—	48.0	1.85	100	PLT	T	Stock	3135-2658	43.22
Black	4 1/2	114.3	5.01	127.3	150	10.3	—	54.0	2.16	100	PLT	T	Stock	3135-2659	45.38
Black	6	152.4	6.51	165.4	150	10.3	—	72.0	2.84	100	PLT	T	MTO	3135-2660	81.68

**RECOMMENDED FOR:** Water and slurry discharge in heavy-duty industrial applications where abrasion-resistance is necessary.

**TEMPERATURE:** -40°F to +150°F (-40°C to +66°C) continuous service.

**CONSTRUCTION:** **Tube:** Type D (SBR). Black.  
**Reinforcement:** Multiple plies of synthetic, high tensile textile.  
**Cover:** Type D (SBR). Black with blue stripe. Abrasion-resistant.  
**Design Factor:** 3:1

**COUPLINGS:** 1, 3, 5, 7, 49 or 78. Reference the Hose Coupling Section.

AGRICULTURE

AIR BREATHING

AIR DUCT

AIR AND MULTI-PURPOSE

CHEMICAL

FOOD AND BEVERAGE

MARINE AND ENGINE

MATERIAL HANDLING

MINING

OILFIELD

PETROLEUM

PRESSURE WASH AND WASHDOWN

STEAM

WATER

CLAMPS

COUPLINGS AND FERRULES

HOSE FINDER

CHEMICAL RESISTANCE TABLE



## Water Hose

### Water Master® 150D AR

Formerly - Marlin®



AGRICULTURE
AIR BREATHING
AIR DUCT
AIR AND MULTI-PURPOSE
CHEMICAL
FOOD AND BEVERAGE
MARINE AND ENGINE
MATERIAL HANDLING
MINING
OILFIELD
PETROLEUM
PRESSURE WASH AND WASHDOWN
STEAM
WATER
CLAMPS
COUPLINGS AND FERRULES
HOSE FINDER
CHEMICAL RESISTANCE TABLE

Color	Hose I.D.	Hose O.D.	Max. W.P.	Vac.	MBR	Wt. Per ft	Length	Std. Pack	Pkg Code	Stock or MTO	Gates Item No.	List Price Per ft			
	(in)	(mm)											(in)	(mm)	(psi)
Black	1 1/2	38.1	1.82	46.2	150	10.3	—	12.0	.47	100	PLT	T	Stock	3137-0370	\$9.81
Black	1 1/2	38.1	1.90	48.3	150	10.3	—	12.0	.63	100	PLT	T	MTO	3137-0371	13.11
Black	2	50.8	2.33	59.2	150	10.3	—	20.0	.65	100	PLT	T	Stock	3137-0372	10.80
Black	2	50.8	2.41	61.2	150	10.3	—	20.0	.84	100	PLT	T	Stock	3137-0373	14.58
Black	2 1/2	63.5	2.83	71.9	150	10.3	—	25.0	.90	100	PLT	T	MTO	3137-0374	15.21
Black	2 1/2	63.5	2.91	73.9	150	10.3	—	25.0	1.02	100	PLT	T	MTO	3137-0375	20.97
Black	3	76.2	3.33	84.6	150	10.3	—	36.0	1.21	100	PLT	T	MTO	3137-0376	15.26
Black	3	76.2	3.41	86.6	150	10.3	—	36.0	1.15	100	PLT	T	MTO	3137-0377	24.33
Black	3 1/2	88.9	3.91	99.3	150	10.3	—	42.0	1.30	100	PLT	T	Stock	3137-0378	30.75
Black	4	101.6	4.33	110.0	150	10.3	—	48.0	1.50	100	PLT	T	Stock	3137-0379	19.22
Black	4	101.6	4.33	110.0	150	10.3	—	48.0	1.50	200	PLT	T	MTO	3137-1272	19.22
Black	4	101.6	4.41	112.0	150	10.3	—	48.0	1.55	100	PLT	T	MTO	3137-0380	36.18
Black	5	127.0	5.44	138.2	150	10.3	—	60.0	2.17	100	PLT	T	Stock	3137-0381	44.73
Black	6	152.4	6.40	162.6	150	10.3	—	72.0	2.60	100	PLT	T	MTO	3137-0382	53.36
Black	6	152.4	6.49	164.8	150	10.3	—	72.0	2.92	100	PLT	T	MTO	3137-0383	74.69

**RECOMMENDED FOR:** Water discharge in heavy-duty service requiring a compact, rugged and lightweight hose.

**TEMPERATURE:** -40°F to +180°F (-40°C to +82°C) continuous service.

**CONSTRUCTION:**  
**Tube:** Type P (EPDM). Black.  
**Reinforcement:** Multiple plies of synthetic, high tensile textile.  
**Cover:** Type D (SBR). Black with blue stripe. Abrasion-resistant.  
**Design Factor:** 3:1

**COUPLINGS:** 1, 3, 5, 7, 49 or 78. Reference the Hose Coupling Section.

## Water Hose

### Water Master® (90-150) D

Formerly - Dolphin®



Color	Hose I.D.		Hose O.D.		Max. W.P.		Vac.	MBR	Wt. Per ft	Length	Std. Pack	Pkg Code	Stock or MTO	Gates Item No.	List Price Per ft
	(in)	(mm)	(in)	(mm)	(psi)	(Bar)	(In. Hg)	(in)	(Lbs.)	(ft)			(ft)		
Black	1 1/4	31.8	1.53	38.9	150	10.3	—	—	.37	100	PLT	T	Stock	3137-0884	\$8.03
Black	1 1/2	38.1	1.78	45.2	150	10.3	—	—	.43	100	PLT	T	Stock	3137-0883	8.78
Black	1 1/2	38.1	1.78	45.2	150	10.3	—	—	.43	200	PLT	T	MTO	3137-0898	8.78
Black	2	50.8	2.32	58.9	150	10.3	—	—	.65	100	PLT	T	Stock	3137-0885	9.75
Black	2	50.8	2.32	58.9	150	10.3	—	—	.65	200	PLT	T	MTO	3137-0905	9.75
Black	2 1/2	63.5	2.82	71.6	150	10.3	—	—	.80	100	PLT	T	Stock	3137-0888	12.68
Black	3	76.2	3.36	85.3	150	10.3	—	—	1.08	100	PLT	T	Stock	3137-0886	14.25
Black	3	76.2	3.36	85.3	150	10.3	—	—	1.08	200	PLT	T	MTO	3137-0895	14.25
Black	4	101.6	4.36	110.7	150	10.3	—	—	1.41	100	PLT	T	Stock	3137-0889	18.83
Black	4	101.6	4.36	110.7	150	10.3	—	—	4.41	200	PLT	T	MTO	3137-0896	18.83
Black	6	152.4	6.38	162.1	125	8.6	—	—	2.09	100	PLT	T	Stock	3137-0890	33.30
Black	6	152.4	6.38	162.1	125	8.6	—	—	2.09	200	PLT	T	MTO	3137-0892	33.30
Black	6 5/8	168.3	7.12	180.8	90	6.2	—	—	3.08	100	PLT	T	MTO	3137-1269	45.23

**RECOMMENDED FOR:** Medium to light-duty water discharge for agricultural, construction and industrial applications. EPDM tube designed to handle a variety of liquids including Lasso®, Lasso II® and Freedom®. (\*Registered Trademarks of Monsanto)

**TEMPERATURE:** -40°F to +180°F (-40°C to +82°C).

**CONSTRUCTION:**  
**Tube:** Type P (EPDM). Black.  
**Reinforcement:** Synthetic, high tensile textile.  
**Cover:** Type P (EPDM). Black with blue stripe.  
**Design Factor:** 3:1

**COUPLINGS:** 5, 6, 7, 8, 49 or 78 all sizes. Reference the Hose Coupling Section.

AGRICULTURE

AIR BREATHING

AIR DUCT

AIR AND MULTI-PURPOSE

CHEMICAL

FOOD AND BEVERAGE

MARINE AND ENGINE

MATERIAL HANDLING

MINING

OILFIELD

PETROLEUM

PRESSURE WASH AND WASHDOWN

STEAM

WATER

CLAMPS

COUPLINGS AND FERRULES

HOSE FINDER

CHEMICAL RESISTANCE TABLE

## Water Hose

### Water Master® PVC (40-100) SD



AGRICULTURE
AIR BREATHING
AIR DUCT
AIR AND MULTI-PURPOSE
CHEMICAL
FOOD AND BEVERAGE
MARINE AND ENGINE
MATERIAL HANDLING
MINING
OILFIELD
PETROLEUM
PRESSURE WASH AND WASHDOWN
STEAM
<b>WATER</b>
CLAMPS
COUPLINGS AND FERRULES
HOSE FINDER
CHEMICAL RESISTANCE TABLE

Color	Hose I.D.		Hose O.D.		Max. W.P.*		Vac.*	MBR	Wt. Per ft	Length	Std. Pack	Pkg Code	Stock or MTO	Gates Item No.	List Price Per ft
	(in)	(mm)	(in)	(mm)	(psi)	(Bar)	(In. Hg)	(in)	(Lbs.)	(ft)			(ft)		
Orange	1 1/2	38.1	2.03	51.6	110	7.6	28.0	2.5	.47	100	PLT	T	Stock	7744-1504	\$9.46
Orange	2	50.8	2.60	66.0	100	6.9	28.0	4.0	.70	100	PLT	T	Stock	7744-1505	10.14
Orange	3	76.2	3.70	94.0	100	6.9	28.0	6.3	1.13	100	PLT	T	Stock	7744-1506	13.02
Orange	4	101.6	4.78	121.4	75	5.2	28.0	7.1	1.74	100	PLT	T	Stock	7744-1507	19.53
Orange	5	127.0	6.04	153.4	70	4.8	28.0	9.2	2.90	100	PLT	T	Stock	7744-1508	39.02
Orange	6	152.4	7.17	182.1	70	4.8	28.0	10.2	3.88	20	PLT	T	Stock	7744-1509	40.00
Orange	6	152.4	7.17	182.1	70	4.8	28.0	10.2	3.88	100	PLT	T	Stock	7744-1510	40.00
Orange	8	203.2	9.34	237.2	60	4.1	28.0	15.7	5.54	20	STRT	T	Stock	7744-1511	64.93

NOTE: \* Working Pressure and Vacuum at +72°F (+22°C).

**RECOMMENDED FOR:** Heavy-duty PVC suction and discharge hose designed for applications requiring combined vacuum and higher working pressures. Excellent for use as a fish suction hose and for rental/construction pumping. Clear sidewall allows for easy inspection of material flow and external helix provides for easy drag.

**TEMPERATURE:** -13°F to +140°F (-25°C to +60°C) continuous service.

**CONSTRUCTION:** **Tube:** Type G1 (Clear PVC). With polyester braid.  
**Reinforcement:** Polyester braid.  
**Cover:** Type G1 (Clear). With rigid orange helix.

**COUPLINGS:** 1, 6, 7, 49, 78 or 84. Reference the Hose Coupling Section.

## Water Hose

### Water Master® PVC Layflat (45-75) D

Formerly - Master-Flex® 500



Color	Hose I.D.		Hose O.D.		Max. W.P.*		Vac.*	MBR	Wt. Per ft	Length	Std. Pack	Pkg Code	Stock or MTO	Gates Item No.	List Price Per ft
	(in)	(mm)	(in)	(mm)	(psi)	(Bar)									
Blue	1 1/2	38.1	1.67	42.4	75	5.2	—	—	.17	300	PLT	T	Stock	7744-1001	\$1.98
Blue	2	50.8	2.16	54.9	65	4.5	—	—	.21	300	PLT	T	Stock	7744-1002	2.42
Blue	2 1/2	63.5	2.55	64.8	60	4.1	—	—	.28	300	PLT	T	MTO	7744-1003	3.45
Blue	3	76.2	3.17	80.5	60	4.1	—	—	.39	300	PLT	T	Stock	7744-1004	4.07
Blue	4	101.6	4.20	106.7	60	4.1	—	—	.53	300	PLT	T	Stock	7744-1005	5.45
Blue	6	152.4	6.20	157.5	45	3.1	—	—	.88	300	PLT	T	Stock	7744-1006	9.08
Blue	8	203.2	8.16	207.3	45	3.1	—	—	1.27	300	PLT	T	Stock	7744-1007	18.15

NOTE: \* Working Pressure and Vacuum at +72°F (+22°C).

- RECOMMENDED FOR:** General layflat water discharge service. Excellent for job sites in construction, irrigation and areas where a lightweight, flexible hose is required.
- TEMPERATURE:** +25°F to +120°F (-4°C to +49°C) continuous service.
- CONSTRUCTION:** **Tube:** Type G (PVC). Blue with yellow identification.  
**Reinforcement:** Synthetic, high tensile textile.  
**Cover:** Type G (PVC). Blue. Smooth.  
**Design Factor:** 3:1
- COUPLINGS:** 5, 6, 7 or 49. One band for 1 1/2". Two bands for 2" I.D. and larger. Reference the Hose Coupling Section.

AGRICULTURE
AIR BREATHING
AIR DUCT
AIR AND MULTI-PURPOSE
CHEMICAL
FOOD AND BEVERAGE
MARINE AND ENGINE
MATERIAL HANDLING
MINING
OILFIELD
PETROLEUM
PRESSURE WASH AND WASHDOWN
STEAM
WATER
CLAMPS
COUPLINGS AND FERRULES
HOSE FINDER
CHEMICAL RESISTANCE TABLE

## Water Hose

### Water Master® Plus PVC Layflat (100-150) D



Color	Hose I.D.		Hose O.D.		Max. W.P.*		Vac.*	MBR	Wt. Per ft	Length	Std. Pack	Pkg Code	Stock or MTO	Gates Item No.	List Price Per ft
	(in)	(mm)	(in)	(mm)	(psi)	(Bar)									
Red	1 1/2	38.1	1.71	43.4	150	10.3	—	—	.23	300	PLT	T	Stock	7744-1538	\$3.29
Red	2	50.8	2.24	56.9	150	10.3	—	—	.36	300	PLT	T	Stock	7744-1539	4.87
Red	2 1/2	63.5	2.79	70.9	150	10.3	—	—	.41	300	PLT	T	Stock	7744-1540	6.18
Red	3	76.2	3.29	83.6	125	8.6	—	—	.46	300	PLT	T	Stock	7744-1541	6.24
Red	4	101.6	4.32	109.7	100	6.9	—	—	.73	300	PLT	T	Stock	7744-1542	8.56
Red	6	152.4	6.40	162.6	100	6.9	—	—	1.18	300	PLT	T	Stock	7744-1543	18.22

NOTE: \* Working Pressure and Vacuum at +72°F (+22°C).

**RECOMMENDED FOR:** For medium-duty discharge applications in mining, construction, industrial, agriculture and marine service. Limited oil and chemical application.

**TEMPERATURE:** -10°F to +150°F (-23°C to +66°C) continuous service.

**CONSTRUCTION:**  
**Tube:** Type G (PVC). Black.  
**Reinforcement:** Spiral synthetic yarn, one layer longitudinal synthetic yarn.  
**Cover:** Type G (PVC). Red.  
**Design Factor:** 3:1

**COUPLINGS:** 5, 6, 7, 49 or 84. Reference the Hose Coupling Section.

AGRICULTURE
AIR BREATHING
AIR DUCT
AIR AND MULTI-PURPOSE
CHEMICAL
FOOD AND BEVERAGE
MARINE AND ENGINE
MATERIAL HANDLING
MINING
OILFIELD
PETROLEUM
PRESSURE WASH AND WASHDOWN
STEAM
WATER
CLAMPS
COUPLINGS AND FERRULES
HOSE FINDER
CHEMICAL RESISTANCE TABLE

## Clamps

### Stainless Steel Clamps



Clamp Size	Hose I.D. Min	Hose I.D. Max	Clamping Range Min	Clamping Range Max	Std. Pack	Pkg Code	Stock or MTO	Gates Item No.	List Price Per ea
	(in)	(in)	(in)	(in)			(ea)		
8	.3125	.5	.4375	1	Bulk	10	Stock	7408-1008	\$3.35
10	.375	.625	.5	1.125	Bulk	10	Stock	7408-1010	3.35
12	.625	.75	.5	1.25	Bulk	10	Stock	7408-1012	3.44
16	.75	1	.75	1.5	Bulk	10	Stock	7408-1016	3.44
20	1	1.25	.75	1.75	Bulk	10	Stock	7408-1020	3.47
24	1.25	1.5	1	2	Bulk	10	Stock	7408-1024	3.47
28	1.25	1.75	1.3125	2.25	Bulk	10	Stock	7408-1028	3.47
32	1.5	2	1.5625	2.5	Bulk	10	Stock	7408-1032	3.47
36	1.75	2.25	1.875	2.75	Bulk	10	Stock	7408-1036	3.47
48	2.5	3	1.625	3.5	Bulk	10	Stock	7408-1048	4.55
52	3	3.25	1.875	3.75	Bulk	10	Stock	7408-1052	4.65
56	2	3.5	2.125	4	Bulk	10	Stock	7408-1056	4.65
60	2.25	3.75	2.3125	4.25	Bulk	10	Stock	7408-1060	4.74
64	2.25	4	2.625	4.5	Bulk	10	Stock	7408-1064	4.77
72	3	4.5	3.5	5	Bulk	10	Stock	7408-1072	4.86
104	5	6.5	5	7	Bulk	10	Stock	7408-1104	5.88

**RECOMMENDED FOR:** Clamping all types of hose and tubing.

**CONSTRUCTION:** Clamps are constructed of 100% marine grade stainless steel. Bands have rounded edges to prevent cutting. Screws feature 305 grade stainless steel construction and deep slotted hex heads.

AGRICULTURE

AIR BREATHING

AIR DUCT

AIR AND MULTI-PURPOSE

CHEMICAL

FOOD AND BEVERAGE

MARINE AND ENGINE

MATERIAL HANDLING

MINING

OILFIELD

PETROLEUM

PRESSURE WASH AND WASHDOWN

STEAM

WATER

CLAMPS

COUPLINGS AND FERRULES

HOSE FINDER

CHEMICAL RESISTANCE TABLE

## Clamps

### Heavy-Duty T-Bolt Clamps



AGRICULTURE
AIR BREATHING
AIR DUCT
AIR AND MULTI-PURPOSE
CHEMICAL
FOOD AND BEVERAGE
MARINE AND ENGINE
MATERIAL HANDLING
MINING
OILFIELD
PETROLEUM
PRESSURE WASH AND WASHDOWN
STEAM
WATER
CLAMPS
COUPLINGS AND FERRULES
HOSE FINDER
CHEMICAL RESISTANCE TABLE

Size	Clamping Range Min		Clamping Range Max		Recommended Torque (in/lbs)	Std. Pack	Pkg Code	Stock or MTO (ea)	Gates Item No.	List Price Per ea
	(in)	(mm)	(in)	(mm)						
N/A	1.375	35.1	1.5625	38.6	75	Bulk	10	Stock	7422-1049	\$8.31
N/A	1.5	38.1	1.625	41.7	75	Bulk	10	Stock	7422-1050	8.34
N/A	1.625	41.4	1.875	46	75	Bulk	10	Stock	7422-1051	8.39
28	1.75	44.5	2	50.8	75	Bulk	10	Stock	7422-1052	8.45
32	1.875	47.8	2.1875	55.6	75	Bulk	10	Stock	7422-1053	8.48
36	2	50.8	2.3125	58.7	75	Bulk	10	Stock	7422-1054	8.54
40	2.125	54.1	2.4375	62	75	Bulk	10	Stock	7422-1055	8.58
44	2.25	57.2	2.5625	65	75	Bulk	10	Stock	7422-1056	8.67
48	2.375	60.5	2.6875	68.3	75	Bulk	10	Stock	7422-1057	8.70
52	2.5	63.5	2.8125	71.4	75	Bulk	10	Stock	7422-1058	8.73
56	2.625	66.8	2.9375	74.7	75	Bulk	10	Stock	7422-1059	8.75
60	2.75	69.9	3.0625	77.7	75	Bulk	10	Stock	7422-1060	8.78
64	2.875	73.2	3.1875	81	75	Bulk	10	Stock	7422-1061	8.84
68	3	76.2	3.3125	84.1	75	Bulk	10	Stock	7422-1062	8.87
72	3.125	79.5	3.4375	87.4	75	Bulk	10	Stock	7422-1063	8.94
76	3.25	82.6	3.5625	90.4	75	Bulk	10	Stock	7422-1064	9.00
80	3.375	85.9	3.6875	93.7	75	Bulk	10	Stock	7422-1065	9.06
84	3.5	88.9	3.8125	96.8	75	Bulk	10	Stock	7422-1066	9.11
88	3.625	92.2	3.9375	100.1	75	Bulk	10	Stock	7422-1067	9.14
92	3.75	95.3	4.0625	103.1	75	Bulk	10	Stock	7422-1068	9.17
100	4	101.6	4.3125	109.5	75	Bulk	10	Stock	7422-1069	9.30
108	4.25	108	4.5625	115.8	75	Bulk	10	Stock	7422-1070	9.39
116	4.5	114.3	4.8125	122.2	75	Bulk	10	Stock	7422-1071	9.50
124	4.75	120.7	5.0625	128.5	75	Bulk	10	Stock	7422-1072	9.59
132	5	127	5.3125	134.9	75	Bulk	10	Stock	7422-1073	9.69
140	5.25	133.4	5.5625	141.2	75	Bulk	10	Stock	7422-1074	9.78
148	5.5	139.7	5.8125	147.6	75	Bulk	10	Stock	7422-1075	9.92
156	5.75	146.1	6.0625	153.9	75	Bulk	10	Stock	7422-1076	9.98
164	6	152.4	6.3125	160.3	75	Bulk	10	Stock	7422-1077	10.05
172	6.25	158.8	6.5625	166.6	75	Bulk	10	Stock	7422-1078	10.17
180	6.5	165.1	6.8125	173	75	Bulk	10	Stock	7422-1079	10.28
188	6.75	171.5	7.0625	179.3	75	Bulk	10	Stock	7422-1080	10.35
196	7	177.8	7.3125	185.7	75	Bulk	10	Stock	7422-1081	10.41
204	7.25	184.2	7.5625	192	75	Bulk	10	Stock	7422-1082	10.53
212	7.5	190.5	7.8125	198.4	75	Bulk	10	Stock	7422-1083	10.64
220	7.75	196.9	8.0625	204.7	75	Bulk	10	Stock	7422-1084	10.74
228	8	203.2	8.3125	211.1	75	Bulk	10	Stock	7422-1085	10.80
236	8.25	209.6	8.5625	217.4	75	Bulk	10	Stock	7422-1086	10.94
244	8.5	215.9	8.8125	223.8	75	Bulk	10	Stock	7422-1087	11.03

**RECOMMENDED FOR:** Use in high vibration and medium-duty applications. Typical applications include industrial machinery, truck air intake systems, cold side charge air systems and off-road equipment.

**CONSTRUCTION:** T-Bolt Standard Design  
**Bolt:** 1/4" - 28 plated steel.  
**Band/Bridge:** 3/4" width, 201/301 stainless steel.  
**Nut:** 7/16" hex, nylon insert, plated steel locknut.  
**Trunnion:** Plated Steel

## Couplings and Ferrules

### GLX® - Male Pipe (NPTF 30° Cone Seat)

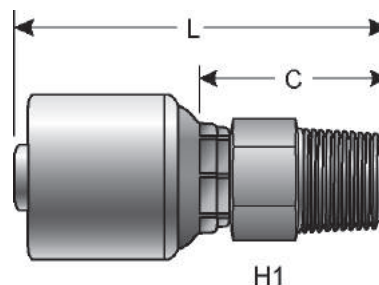

#### Standard Pack

Description	Hose I.D.	Thread	H1		L		C		Wt. Per ea (Lbs.)	Std. Pack	Pkg Code	Stock or MTO (ea)	Gates Item No.	List Price Per ea
	(in)		(in)	(in)	(mm)	(in)	(mm)							
4GLX-2MP	1/4	1/8-27	1/2	2.01	51.1	.98	24.9	.10	Bulk	1	Stock	7107-00105	\$8.13	
4GLX-4MP	1/4	1/4-18	9/16	2.17	55.1	1.14	29.0	.12	Bulk	1	Stock	7107-00115	7.26	
6GLX-4MP	3/8	1/4-18	11/16	2.32	58.9	1.22	31.0	.15	Bulk	1	Stock	7107-00135	9.27	
6GLX-6MP	3/8	3/8-18	11/16	2.32	58.9	1.22	31.0	.17	Bulk	1	Stock	7107-00145	8.22	
8GLX-6MP	1/2	3/8-18	13/16	2.72	69.1	1.24	31.5	.05	Bulk	1	Stock	7107-00165	14.99	
8GLX-8MP	1/2	1/2-14	7/8	2.78	70.6	1.40	35.6	.30	Bulk	1	Stock	7107-00175	9.24	
8GLX-12MP	1/2	3/4-14	13/16	3.46	87.9	1.45	36.8	.15	Bulk	1	Stock	7107-00785	14.84	
10GLX-8MP	5/8	1/2-14	15/16	2.40	61.0	1.55	39.4	.22	Bulk	1	Stock	7107-00195	10.41	
12GLX-8MP	3/4	1/2-14	1 1/16	3.46	87.9	1.46	37.1	.45	Bulk	1	Stock	7107-00215	19.19	
12GLX-12MP	3/4	3/4-14	1 1/16	3.46	87.9	1.46	37.1	.45	Bulk	1	Stock	7107-00225	16.25	
16GLX-16MP	1	1-11 1/2	1 3/8	4.11	104.4	1.88	47.8	.80	Bulk	1	Stock	7107-00255	31.53	
20GLX-20MP	1 1/4	1 1/4-11 1/2	1 3/4	4.41	112.0	2.09	53.1	1.20	Bulk	1	Stock	7107-00265	64.98	

#### Bulk Pack

Description	Hose I.D.	Thread	H1		L		C		Wt. Per ea (Lbs.)	Std. Pack	Pkg Code	Stock or MTO (ea)	Gates Item No.	List Price Per ea
	(in)		(in)	(in)	(mm)	(in)	(mm)							
4GLX-2MPXBULK	1/4	1/8-27	1/2	2.01	51.1	.98	24.9	.10	Bulk	300	MTO	7107-0010	\$7.40	
4GLX-4MPXBULK	1/4	1/4-18	9/16	2.17	55.1	1.14	29.0	.12	Bulk	200	Stock	7107-0011	6.60	
6GLX-4MPXBULK	3/8	1/4-18	11/16	2.32	58.9	1.22	31.0	.14	Bulk	200	Stock	7107-0013	8.42	
6GLX-6MPXBULK	3/8	3/8-18	11/16	2.32	58.9	1.22	31.0	.16	Bulk	150	Stock	7107-0014	7.47	
8GLX-6MPXBULK	1/2	3/8-18	13/16	2.72	69.1	1.24	31.5	.24	Bulk	100	MTO	7107-0016	13.62	
8GLX-8MPXBULK	1/2	1/2-14	7/8	2.78	70.6	1.40	35.6	.29	Bulk	100	Stock	7107-0017	8.40	
8GLX-12MPXBULK	1/2	3/4-14	13/16	3.46	87.9	1.45	36.8	.35	Bulk	100	Stock	7107-0078	13.49	
10GLX-8MPXBULK	5/8	1/2-14	15/16	2.40	61.0	1.55	39.4	.22	Bulk	100	MTO	7107-0019	9.47	
12GLX-8MPXBULK	3/4	1/2-14	1 1/16	3.46	87.9	1.46	37.1	.45	Bulk	60	Stock	7107-0021	17.43	
12GLX-12MPXBULK	3/4	3/4-14	1 1/16	3.46	87.9	1.46	37.1	.49	Bulk	75	Stock	7107-0022	14.78	
16GLX-16MPXBULK	1	1-11 1/2	1 3/8	4.11	104.4	1.88	47.8	.80	Bulk	25	Stock	7107-0025	28.67	
20GLX-20MPXBULK	1 1/4	1 1/4-11 1/2	1 3/4	4.41	112.0	2.09	53.1	1.20	Bulk	20	Stock	7107-0026	59.07	

AGRICULTURE

AIR BREATHING

AIR DUCT

AIR AND MULTI-PURPOSE

CHEMICAL

FOOD AND BEVERAGE

MARINE AND ENGINE

MATERIAL HANDLING

MINING

OILFIELD

PETROLEUM

PRESSURE WASH AND WASHDOWN

STEAM

WATER

CLAMPS

COUPLINGS AND FERRULES

HOSE FINDER

CHEMICAL RESISTANCE TABLE



## Couplings and Ferrules

### GLX® - MS 45° SAE Male Solid

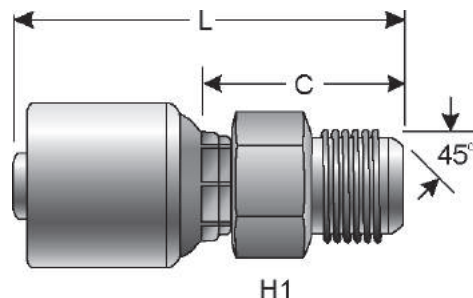

H1

#### Standard Pack

Description	Hose I.D.	Thread	H1 (in)	L		C		Wt. Per ea (Lbs.)	Std. Pack	Pkg Code	Stock or MTO (ea)	Gates Item No.	List Price Per ea
	(in)			(in)	(mm)	(in)	(mm)						
4GLX-4MS	1/4	7/16-20	1/2	2.11	53.6	1.08	27.4	.09	Bulk	1	Stock	7107-00525	\$11.30
6GLX-6MS	3/8	5/8-18	5/8	2.38	60.5	1.28	32.5	.15	Bulk	1	Stock	7107-00535	13.82
8GLX-8MS	1/2	3/4-16	13/16	2.89	73.4	1.42	36.1	.25	Bulk	1	Stock	7107-00545	15.60
12GLX-12MS	3/4	1 1/16-14	1 1/16	3.78	96.0	1.77	45.0	.54	Bulk	1	Stock	7107-00555	38.60

#### Bulk Pack

Description	Hose I.D.	Thread	H1 (in)	L		C		Wt. Per ea (Lbs.)	Std. Pack	Pkg Code	Stock or MTO (ea)	Gates Item No.	List Price Per ea
	(in)			(in)	(mm)	(in)	(mm)						
4GLX-4MSXBULK	1/4	7/16-20	1/2	2.11	53.6	1.08	27.4	.10	Bulk	300	MTO	7107-0052	\$10.28
6GLX-6MSXBULK	3/8	5/8-18	5/8	2.38	60.5	1.28	32.5	.15	Bulk	225	MTO	7107-0053	12.56
8GLX-8MSXBULK	1/2	3/4-16	13/16	2.89	73.4	1.42	36.1	.25	Bulk	100	MTO	7107-0054	14.18
12GLX-12MSXBULK	3/4	1 1/16-14	1 1/16	3.78	96.0	1.77	45.0	.51	Bulk	50	MTO	7107-0055	35.09

AGRICULTURE
AIR BREATHING
AIR DUCT
AIR AND MULTI-PURPOSE
CHEMICAL
FOOD AND BEVERAGE
MARINE AND ENGINE
MATERIAL HANDLING
MINING
OILFIELD
PETROLEUM
PRESSURE WASH AND WASHDOWN
STEAM
WATER
CLAMPS
<b>COUPLINGS AND FERRULES</b>
HOSE FINDER
CHEMICAL RESISTANCE TABLE

GLX® - FSX 45° SAE Female Swivel

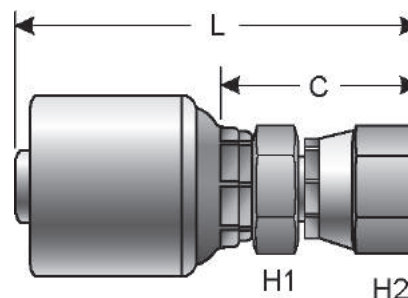

Standard Pack

Description	Hose I.D.	Thread	H1	L		C		Wt. Per ea (Lbs.)	Std. Pack	Pkg Code	Stock or MTO (ea)	Gates Item No.	List Price Per ea
	(in)		(in)	(in)	(mm)	(in)	(mm)						
4GLX-4FSX	1/4	7/16-20	1/2	2.24	56.9	1.22	31.0	.10	Bulk	1	Stock	7107-00485	\$12.32
6GLX-6FSX	3/8	5/8-18	5/8	2.44	62.0	1.35	34.3	.15	Bulk	1	Stock	7107-00495	10.82
8GLX-8FSX	1/2	3/4-16	13/16	2.82	71.6	1.34	34.0	.24	Bulk	1	Stock	7107-00505	13.80
12GLX-12FSX	3/4	1 1/16-14	1 1/16	3.68	93.5	1.67	42.4	.51	Bulk	1	Stock	7107-00515	23.03

Bulk Pack

Description	Hose I.D.	Thread	H1	L		C		Wt. Per ea (Lbs.)	Std. Pack	Pkg Code	Stock or MTO (ea)	Gates Item No.	List Price Per ea
	(in)		(in)	(in)	(mm)	(in)	(mm)						
4GLX-4FSXXBULK	1/4	7/16-20	1/2	2.24	56.9	1.22	31.0	.10	Bulk	300	MTO	7107-0048	\$11.21
6GLX-6FSX XBULK	3/8	5/8-18	5/8	2.44	62.0	1.35	34.3	.15	Bulk	200	Stock	7107-0049	9.84
8GLX-8FSX XBULK	1/2	3/4-16	13/16	2.82	71.6	1.34	34.0	.24	Bulk	100	Stock	7107-0050	12.56
12GLX-12FSX XBULK	3/4	1 1/16-14	1 1/16	3.68	93.5	1.67	42.4	.51	Bulk	40	MTO	7107-0051	20.94

AGRICULTURE

AIR BREATHING

AIR DUCT

AIR AND MULTI-PURPOSE

CHEMICAL

FOOD AND BEVERAGE

MARINE AND ENGINE

MATERIAL HANDLING

MINING

OILFIELD

PETROLEUM

PRESSURE WASH AND WASHDOWN

STEAM

WATER

CLAMPS

COUPLINGS AND FERRULES

HOSE FINDER

CHEMICAL RESISTANCE TABLE

## Couplings and Ferrules

### GLX® - MPX Male NPTF Swivel

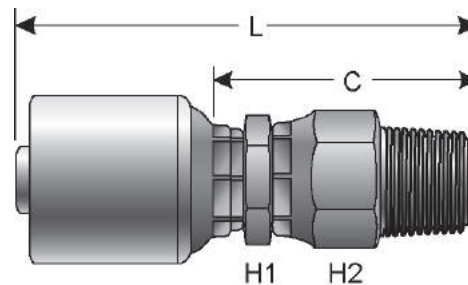

#### Standard Pack

Description	Hose I.D.	Thread	H1	H2	L		C		Wt. Per ea (Lbs.)	Std. Pack	Pkg Code	Stock or MTO (ea)	Gates Item No.	List Price Per ea
	(in)		(in)	(in)	(in)	(in)	(mm)	(in)						
4GLX-4MPX	1/4	1/4-18	1/2	11/16	2.61	66.3	1.58	40.1	.15	Bulk	1	Stock	7107-00565	\$14.90
6GLX-6MPX	3/8	3/8-18	5/8	7/8	2.81	71.4	1.72	43.7	.25	Bulk	1	Stock	7107-00575	16.29
8GLX-8MPX	1/2	1/2-14	13/16	1	3.42	86.9	1.95	49.5	.37	Bulk	1	Stock	7107-00585	19.53
12GLX-12MPX	3/4	3/4-14	1 1/16	1 5/16	4.02	102.1	2.01	51.1	.59	Bulk	1	Stock	7107-00595	34.13
16GLX-16MPX	1	1-11 1/2	1 3/8	1 5/8	4.73	120.1	2.50	63.5	.97	Bulk	1	Stock	7107-00605	51.95
20GLX-20MPX	1 1/4	1 1/4-11 1/2	1 7/8	2	5.30	134.6	2.98	75.7	1.78	Bulk	1	Stock	7107-00615	90.09

#### Bulk Pack

Description	Hose I.D.	Thread	H1	H2	L		C		Wt. Per ea (Lbs.)	Std. Pack	Pkg Code	Stock or MTO (ea)	Gates Item No.	List Price Per ea
	(in)		(in)	(in)	(in)	(in)	(mm)	(in)						
4GLX-4MPX XBULK	1/4	1/4-18	1/2	11/16	2.61	66.3	1.58	40.1	.14	Bulk	200	Stock	7107-0056	\$13.53
6GLX-6MPX XBULK	3/8	3/8-18	5/8	7/8	2.81	71.4	1.72	43.7	.24	Bulk	100	Stock	7107-0057	14.81
8GLX-8MPX XBULK	1/2	1/2-14	13/16	1	3.42	86.9	1.95	49.5	.36	Bulk	100	Stock	7107-0058	17.75
12GLX-12MPX XBULK	3/4	3/4-14	1 1/16	1 5/16	4.02	102.1	2.01	51.1	.59	Bulk	50	Stock	7107-0059	31.02
16GLX-16MPX XBULK	1	1-11 1/2	1 3/8	1 5/8	4.73	120.1	2.50	63.5	.97	Bulk	25	Stock	7107-0060	47.22
20GLX-20MPX XBULK	1 1/4	1 1/4-11 1/2	1 7/8	2	5.30	134.6	2.98	75.7	1.78	Bulk	25	Stock	7107-0061	81.90

## Couplings and Ferrules

### GLX® - FP Female NPTF Solid

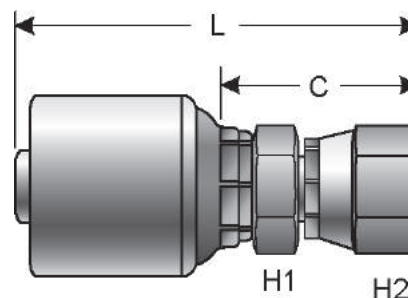

#### Standard Pack

Description	Hose I.D.	Thread	H1	L		C		Wt. Per ea (Lbs.)	Std. Pack	Pkg Code	Stock or MTO (ea)	Gates Item No.	List Price Per ea
	(in)		(in)	(in)	(in)	(mm)	(in)						
4GLX-4FP	1/4	1/4-18	11/16	1.99	50.6	.96	24.4	.11	Bulk	1	Stock	7107-00415	\$13.08
6GLX-4FP	3/8	1/4-18	11/16	2.07	52.6	.97	24.6	.15	Bulk	1	Stock	7107-00425	19.40
6GLX-6FP	3/8	3/8-18	13/16	2.07	52.6	.97	24.6	.18	Bulk	1	Stock	7107-00435	11.16
8GLX-6FP	1/2	3/8-18	13/16	2.48	63.0	1.00	25.4	.24	Bulk	1	Stock	7107-00445	20.43
8GLX-8FP	1/2	1/2-14	1	2.64	67.1	1.16	29.5	.26	Bulk	1	Stock	7107-00455	15.45
12GLX-12FP	3/4	3/4-14	1 1/4	3.23	82.0	1.22	31.0	.48	Bulk	1	Stock	7107-00465	21.90
16GLX-16FP	1	1-11 1/2	1 1/2	3.86	98.1	1.62	41.2	.73	Bulk	1	Stock	7107-00475	42.47

#### Bulk Pack

Description	Hose I.D.	Thread	H1	L		C		Wt. Per ea (Lbs.)	Std. Pack	Pkg Code	Stock or MTO (ea)	Gates Item No.	List Price Per ea
	(in)		(in)	(in)	(mm)	(in)	(mm)						
4GLX-4FPXBULK	1/4	1/4-18	11/16	1.99	50.6	.96	24.4	.11	Bulk	300	Stock	7107-0041	\$11.88
6FLX-4FPXBULK	3/8	1/4-18	11/16	2.07	52.6	.97	24.6	.16	Bulk	250	MTO	7107-0042	17.63
6GLX-6FPXBULK	3/8	3/8-18	13/16	2.07	52.6	.97	24.6	.15	Bulk	250	MTO	7107-0043	10.14
8GLX-6FPXBULK	1/2	3/8-18	13/16	2.48	63.0	1.00	25.4	.24	Bulk	125	Stock	7107-0044	19.26
8GLX-8FPXBULK	1/2	1/2-14	1	2.64	67.1	1.16	29.5	.26	Bulk	125	Stock	7107-0045	14.04
12GLX-12FPXBULK	3/4	3/4-14	1 1/4	3.23	82.0	1.22	31.0	.45	Bulk	50	Stock	7107-0046	19.91
16GLX-16FPXBULK	1	1-11 1/2	1 1/2	3.86	98.1	1.62	41.2	.73	Bulk	40	MTO	7107-0047	38.61

AGRICULTURE

AIR BREATHING

AIR DUCT

AIR AND MULTI-PURPOSE

CHEMICAL

FOOD AND BEVERAGE

MARINE AND ENGINE

MATERIAL HANDLING

MINING

OILFIELD

PETROLEUM

PRESSURE WASH AND WASHDOWN

STEAM

WATER

CLAMPS

COUPLINGS AND FERRULES

HOSE FINDER

CHEMICAL RESISTANCE TABLE

## Couplings and Ferrules

### GLX® - FPX Female NPSM Swivel

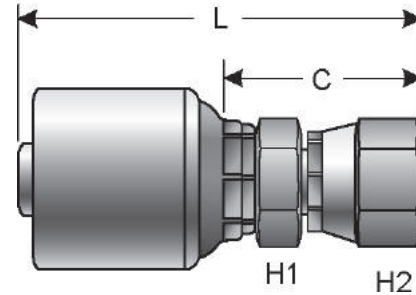

#### Standard Pack

Description	Hose I.D.	Thread	H1	H2	L		C		Wt. Per ea (Lbs.)	Std. Pack	Pkg Code	Stock or MTO (ea)	Gates Item No.	List Price Per ea
	(in)		(in)	(in)	(in)	(in)	(mm)	(in)						
4GLX-4FPX	1/4	1/4-18	1/2	11/16	2.24	56.9	1.22	31.0	.12	Bulk	1	Stock	7107-00345	\$16.05
6GLX-4FPX	3/8	1/4-18	5/8	11/16	2.40	61.0	1.30	33.0	.16	Bulk	1	Stock	7107-00355	18.53
6GLX-6FPX	3/8	3/8-18	5/8	7/8	2.49	63.3	1.39	35.3	.22	Bulk	1	Stock	7107-00365	22.17
8GLX-6FPX	1/2	3/8-18	13/16	7/8	2.85	72.4	1.38	35.1	.30	Bulk	1	Stock	7107-00375	24.18
8GLX-8FPX	1/2	1/2-14	13/16	1	2.89	73.4	1.41	35.8	.30	Bulk	1	Stock	7107-00385	24.26
12GLX-12FPX	3/4	3/4-14	1 1/16	1 1/4	3.72	94.5	1.71	43.4	.54	Bulk	1	Stock	7107-00395	30.36
16GLX-16FPX	1	1-11 1/2	1 3/8	1 1/2	4.11	104.4	1.87	47.5	.98	Bulk	1	Stock	7107-00405	44.42

#### Bulk Pack

Description	Hose I.D.	Thread	H1	H2	L		C		Wt. Per ea (Lbs.)	Std. Pack	Pkg Code	Stock or MTO (ea)	Gates Item No.	List Price Per ea
	(in)		(in)	(in)	(in)	(in)	(mm)	(in)						
4GLX-4FPXXBULK	1/4	1/4-18	1/2	11/16	2.24	56.9	1.22	31.0	.12	Bulk	300	MTO	7107-0034	\$14.58
6FLX-4FPX XBULK	3/8	1/4-18	5/8	11/16	2.40	61.0	1.30	33.0	.16	Bulk	225	Stock	7107-0035	16.85
6GLX-6FPX XBULK	3/8	3/8-18	5/8	7/8	2.49	63.3	1.39	35.3	.20	Bulk	200	Stock	7107-0036	20.15
8GLX-6FPX XBULK	1/2	3/8-18	13/16	7/8	2.85	72.4	1.38	35.1	.30	Bulk	125	Stock	7107-0037	21.98
8GLX-8FPX XBULK	1/2	1/2-14	13/16	1	2.89	73.4	1.41	35.8	.30	Bulk	100	MTO	7107-0038	22.05
12GLX-12FPX XBULK	3/4	3/4-14	1 1/16	1 1/4	3.72	94.5	1.71	43.4	.54	Bulk	50	MTO	7107-0039	27.60
16GLX-16FPX XBULK	1	1-11 1/2	1 3/8	1 1/2	4.11	104.4	1.87	47.5	.78	Bulk	40	Stock	7107-0040	40.38

## Couplings and Ferrules

### GLX® - Female JIC 37° Flare Swivel

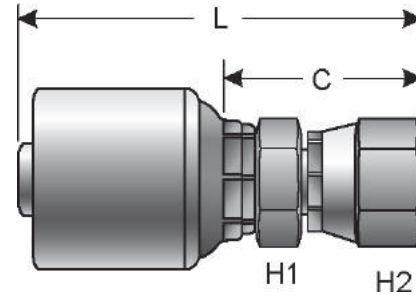

#### Standard Pack

Description	Hose I.D.	Thread	H1	H2	L		C		Wt. Per ea (Lbs.)	Std. Pack	Pkg Code	Stock or MTO (ea)	Gates Item No.	List Price Per ea
	(in)		(in)	(in)	(in)	(in)	(mm)	(in)						
4GLX-4FJX	1/4	7/16-20	1/2	9/16	2.10	53.3	1.08	27.4	.11	Bulk	1	Stock	7107-00275	\$8.48
6GLX-6FJX	3/8	9/16-18	5/8	3/4	2.31	58.7	1.19	30.2	.17	Bulk	1	Stock	7107-00285	9.75
8GLX-8FJX	1/2	3/4-16	13/16	7/8	2.82	71.6	1.34	34.0	.30	Bulk	1	Stock	7107-00295	11.93
10GLX-10FJX	5/8	7/8-14	—	1 1/16	2.27	57.7	1.42	36.1	.24	Bulk	1	Stock	7107-00305	13.46
12GLX-12FJX	3/4	1 1/16-12	1 1/16	1 1/4	3.68	93.5	1.67	42.4	.50	Bulk	1	Stock	7107-00315	20.36
16GLX-16FJX	1	1 5/16-12	1 3/8	1 1/2	4.17	105.9	1.94	49.3	1.08	Bulk	1	Stock	7107-00325	37.73
20GLX-20FJX	1 1/4	1 5/8-12	1 3/4	2	4.58	116.3	2.26	57.4	1.30	Bulk	1	Stock	7107-00335	83.21

#### Bulk Pack

Description	Hose I.D.	Thread	H1	H2	L		C		Wt. Per ea (Lbs.)	Std. Pack	Pkg Code	Stock or MTO (ea)	Gates Item No.	List Price Per ea
	(in)		(in)	(in)	(in)	(in)	(mm)	(in)						
4GLX-4FJXXBULK	1/4	7/16-20	1/2	9/16	2.10	53.3	1.08	27.4	.10	Bulk	200	Stock	7107-0027	\$7.71
6GLX-6FJX XBULK	3/8	9/16-18	5/8	3/4	2.31	58.7	1.19	30.2	.15	Bulk	150	Stock	7107-0028	8.87
8GLX-8FJX XBULK	1/2	3/4-16	13/16	7/8	2.82	71.6	1.34	34.0	.34	Bulk	100	Stock	7107-0029	11.45
10GLX-10FJX XBULK	5/8	7/8-14	—	1 1/16	2.27	57.7	1.42	36.1	.24	Bulk	100	MTO	7107-0030	12.23
12GLX-12FJX XBULK	3/4	1 1/16-12	1 1/16	1 1/4	3.68	93.5	1.67	42.4	.55	Bulk	75	Stock	7107-0031	18.51
16GLX-16FJX XBULK	1	1 5/16-12	1 3/8	1 1/2	4.17	105.9	1.94	49.3	1.08	Bulk	25	Stock	7107-0032	34.29
20GLX-20FJX XBULK	1 1/4	1 5/8-12	1 3/4	2	4.58	116.3	2.26	57.4	1.40	Bulk	20	Stock	7107-0033	75.65

AGRICULTURE

AIR BREATHING

AIR DUCT

AIR AND MULTI-PURPOSE

CHEMICAL

FOOD AND BEVERAGE

MARINE AND ENGINE

MATERIAL HANDLING

MINING

OILFIELD

PETROLEUM

PRESSURE WASH AND WASHDOWN

STEAM

WATER

CLAMPS

COUPLINGS AND FERRULES

HOSE FINDER

CHEMICAL RESISTANCE TABLE

**GSM™ with Integral 2" Fig. 1502 Hammer Unions**

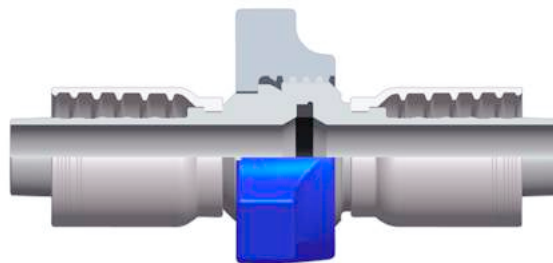

**2" Figure 1502 Female Sub with Seal**

Description	Hose I.D.	L		C		Wt. Per ea	Std. Pack	Pkg Code	Stock or MTO	Gates Item No.	List Price Per ea
	(in)	(in)	(mm)	(in)	(mm)	(Lbs.)			(ea)		
24GSM-32FHU	1 1/2	2.52	64.0	6.26	159.0	5.49	Bulk	1	Stock	7341-02675	\$318.65
32GSM-32FHU	2	7.35	186.0	2.86	72.6	8.65	Bulk	1	Stock	7341-20315	350.72

**2" Figure 1502 Male Sub with Nut**

Description	Hose I.D.	L		C		Wt. Per ea	Std. Pack	Pkg Code	Stock or MTO	Gates Item No.	List Price Per ea
	(in)	(in)	(mm)	(in)	(mm)	(Lbs.)			(ea)		
24GSM-32MHUWN	1 1/2	6.64	168.7	2.90	73.7	16.43	Bulk	1	Stock	7341-02695	\$485.33
32GSM-32MHUWN	2	7.25	184.1	2.76	70.1	18.50	Bulk	1	Stock	7341-20335	502.34

**2" Figure 1502 Male Sub without Nut**

Description	Hose I.D.	L		C		Wt. Per ea	Std. Pack	Pkg Code	Stock or MTO	Gates Item No.	List Price Per ea
	(in)	(in)	(mm)	(in)	(mm)	(Lbs.)			(ea)		
24GSM-32MHU	1 1/2	6.64	168.7	2.90	73.7	6.38	Bulk	1	Stock	7341-02685	\$228.62
32GSM-32MHU	2	7.25	184.1	2.76	70.1	8.18	Bulk	1	Stock	7341-20325	382.99

**2" Figure 1502 Rubber Lip Seal and Wing Nut**

Description	Hose I.D.	Wt. Per ea	Std. Pack	Pkg Code	Stock or MTO	Gates Item No.	List Price Per ea
	(in)	(Lbs.)			(ea)		
-32 SR	2	.05	Bulk	1	Stock	7253-01905	\$62.46
-32 WN	2	9.20	Bulk	1	Stock	7253-01915	259.53

**GSM™ Butt Weld**

Description	Hose I.D.	L		C		Wt. Per ea	Std. Pack	Pkg Code	Stock or MTO	Gates Item No.	List Price Per ea
	(in)	(in)	(mm)	(in)	(mm)	(Lbs.)			(ea)		
32GSM-32S160BW	2	6.68	169.7	2.19	55.7	5.74	Bulk	1	MTO	7341-20385	\$389.24
32GSM-32XXSBW	2	7.19	182.5	2.70	68.5	6.22	Bulk	1	Stock	7341-20365	206.68
32GSM-40S160BW	2	6.65	168.9	2.16	54.9	5.83	Bulk	1	Stock	7341-20375	403.99
32GSM-48XXSBW	2	6.61	168.0	2.13	54.0	6.49	Bulk	1	Stock	7341-20395	326.46
40GSM-40XXSBW	2	8.46	215.0	2.44	62.0	9.38	Bulk	1	Stock	7341-20185	466.18

AGRICULTURE
AIR BREATHING
AIR DUCT
AIR AND MULTI-PURPOSE
CHEMICAL
FOOD AND BEVERAGE
MARINE AND ENGINE
MATERIAL HANDLING
MINING
OILFIELD
PETROLEUM
PRESSURE WASH AND WASHDOWN
STEAM
WATER
CLAMPS
COUPLINGS AND FERRULES
HOSE FINDER
CHEMICAL RESISTANCE TABLE

## Air Master™ Diving Air Hose Couplings

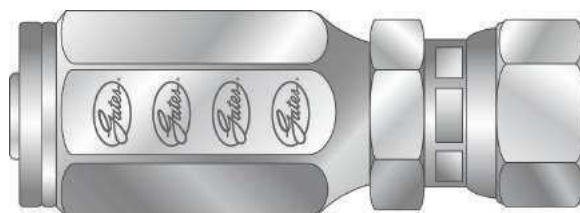

### Ferrule

Description	Size	Wt. Per ea	Std. Pack	Stock or MTO	Gates Item No.	List Price Per ea
	(in)	(Lbs.)		(ea)		
33HB-6-FRLB	3/8	.08	Bulk	MTO	7207-0597	\$6.98
33HB-8-8FRLB	1/2	.18	Bulk	MTO	7107-0501	32.99

### Stems

Description	Size	Wt. Per ea	Std. Pack	Stock or MTO	Gates Item No.	List Price Per ea
	(in)	(Lbs.)		(ea)		
33HB-6-6RFJX-STB	3/8	.09	Bulk	MTO	7207-0598	\$32.82
33HB-6-6ROXY-STB	3/8	.11	Bulk	MTO	7207-0599	24.17
33HB-8-10RFJSX-STB	1/2	.27	Bulk	MTO	7107-0500	35.50

NOTE: These couplings are to be used with Air Master™ Diving Umbilical hose only. Air Master™ Diving assemblies made with Gates Divers' air couplings are rated at 250 PSI maximum working pressure.

AGRICULTURE

AIR BREATHING

AIR DUCT

AIR AND MULTI-PURPOSE

CHEMICAL

FOOD AND BEVERAGE

MARINE AND ENGINE

MATERIAL HANDLING

MINING

OILFIELD

PETROLEUM

PRESSURE WASH AND WASHDOWN

STEAM

WATER

CLAMPS

COUPLINGS AND FERRULES

HOSE FINDER

CHEMICAL RESISTANCE TABLE



## Couplings and Ferrules

### Pressure Wash Swivel

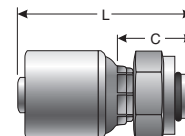

Description	Hose ID	Thread	L		C		Wt. Per Ea (lbs)	Std. Pack	Stock or MTO (ea)	Gates Item No.	List Price Per Ea
	(in)		(in)	(mm)	(in)	(mm)					
4G-6PWX	1/4	M22X1.5	2.52	64.0	1.5	38.0	.25	1	Stock	7100-02905	\$48.84
6G-6PWX	3/8	M22X1.5	2.60	66.0	1.5	38.1	.27	1	Stock	7100-02915	\$49.75

## BRASS LOCK-ON STEM

### Male Pipe with Cone Seat

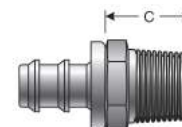

Description	Hose ID	Thread	C		Wt. Per Ea (lbs)	Std. Pack	Stock or MTO (ea)	Gates Item No.	List Price Per Ea
	(in)		(in)	(mm)					
4LOC-2RMP	1/4	1/8-27	.56	14.2	.04	1	Stock	7250-04435	\$5.02
4LOC-4RMP	1/4	1/4-18	.81	20.6	.04	1	Stock	7250-04445	\$4.40
4LOC-6RMP	1/4	3/8-18	.88	22.4	.05	1	Stock	7250-16065	\$4.87
5LOC-2RMP	5/16	1/8-27	.81	20.6	.04	1	Stock	7250-04455	\$6.12
5LOC-4RMP	5/16	1/4-18	.77	19.6	.06	1	Stock	7250-04465	\$6.49
6LOC-2RMP	3/8	1/8-27	.56	14.2	.06	1	Stock	7250-04475	\$3.59
6LOC-4RMP	3/8	1/4-18	.81	20.6	.06	1	Stock	7250-04485	\$8.05
6LOC-6RMP	3/8	3/8-18	.88	22.4	.10	1	Stock	7250-04495	\$7.33
6LOC-8RMP	3/8	1/2-14	.88	22.4	.01	1	Stock	7250-16075	\$6.87
8LOC-4RMP	1/2	1/4-18	.81	20.6	.10	1	Stock	7250-16085	\$5.46
8LOC-6RMP	1/2	3/8-18	.88	22.4	.08	1	Stock	7250-04505	\$13.45
8LOC-8RMP	1/2	1/2-14	.88	22.4	.14	1	Stock	7250-04515	\$11.11
8LOC-12RMP	1/2	3/4-14	1.13	28.7	.16	1	Stock	7250-16095	\$9.02
10LOC-6RMP	5/8	3/8-18	.88	22.4	.20	1	Stock	7250-16105	\$11.95
10LOC-8RMP	5/8	1/2-14	1.06	26.9	.14	1	Stock	7250-04525	\$13.04
10LOC-12RMP	5/8	3/4-14	.88	22.4	.20	1	Stock	7250-16115	\$10.27
12LOC-8RMP	3/4	1/2-14	.88	22.4	.20	1	Stock	7250-16125	\$9.49
12LOC-12RMP	3/4	3/4-14	1.13	28.7	.20	1	Stock	7250-04535	\$18.23

## Couplings and Ferrules

### Female Pipe Swivel With Cone Seat

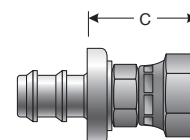

Description	Hose ID (in)	Thread	C		Wt. Per Ea (lbs)	Std. Pack	Stock or MOQ (ea)	Gates Item No.	List Price Per Ea
			(in)	(mm)					
4LOC-2RFPX	1/4	1/8-27	1.81	46.0	.04	1	Stock	7250-16265	\$11.36
4LOC-4RFPX	1/4	1/4-18	1.81	46.0	.06	1	Stock	7250-16275	\$11.77
4LOC-6RFPX	1/4	3/8-18	2.00	50.8	.08	1	Stock	7250-16285	\$11.36
6LOC-4RFPX	3/8	1/4-18	1.81	46.0	.08	1	Stock	7250-16295	\$16.60
6LOC-6RFPX	3/8	3/8-18	2.00	50.8	.10	1	Stock	7250-16305	\$15.42
6LOC-8RFPX	3/8	1/2-14	2.38	60.5	.10	1	Stock	7250-16315	\$16.42
8LOC-8RFPX	1/2	1/2-14	2.38	60.5	.12	1	Stock	7250-16325	\$23.81
10LOC-12RFPX	3/4	3/4-14	2.68	68.1	.26	1	Stock	7250-16345	\$27.09
12LOC-12RFPX	3/4	3/4-14	2.68	68.1	.20	1	Stock	7250-16355	\$27.49

### Male SAE 45° Flare

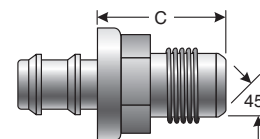

Description	Hose ID (in)	Thread	C		Wt. Per Ea (lbs)	Std. Pack	Stock or MOQ (ea)	Gates Item No.	List Price Per Ea
			(in)	(mm)					
4LOC-4RMS	1/4	7/16-20	.69	17.5	.04	1	Stock	7250-04645	\$4.28
4LOC-5RMS	1/4	1/2-20	.38	9.7	.04	1	Stock	7250-04655	\$5.15
4LOC-6RMS	1/4	5/8-18	.88	22.4	.06	1	Stock	7250-04665	\$9.05
5LOC-5RMS	5/16	1/2-20	.81	20.6	.06	1	Stock	7250-04675	\$5.52
6LOC-4RMS	3/8	7/16-20	.69	17.5	.06	1	Stock	7250-16505	\$17.01
6LOC-5RMS	3/8	1/2-20	.81	20.6	.06	1	Stock	7250-16515	\$11.36
6LOC-6RMS	3/8	5/8-18	.88	22.4	.08	1	Stock	7250-04685	\$6.87
6LOC-8RMS	3/8	3/4-16	1.31	33.3	.15	1	Stock	7250-16525	\$52.15
8LOC-8RMS	1/2	3/4-16	1.13	28.7	.12	1	Stock	7250-18285	\$19.63
8LOC-10RMS	1/2	7/8-14	1.27	32.3	.18	1	Stock	7250-16535	\$13.83
10LOC-8RMS	5/8	3/4-16	1.13	28.7	.20	1	Stock	7250-16545	\$32.27
10LOC-10RMS	5/8	7/8-14	1.27	32.3	.18	1	Stock	7250-16555	\$19.88
12LOC-10RMS	3/4	7/8-14	1.27	32.3	.26	1	Stock	7250-16565	\$20.50
12LOC-12RMS	3/4	1 1/16-14	1.83	46.5	.32	1	Stock	7250-16575	\$21.44

AGRICULTURE

AIR BREATHING

AIR DUCT

AIR AND MULTI-PURPOSE

CHEMICAL

FOOD AND BEVERAGE

MARINE AND ENGINE

MATERIAL HANDLING

MINING

OILFIELD

PETROLEUM

PRESSURE WASH AND WASHDOWN

STEAM

WATER

CLAMPS

COUPLINGS AND FERRULES

HOSE FINDER

CHEMICAL RESISTANCE TABLE

## Couplings and Ferrules

### Dual Seat Female JIC 37°/SAE 45° Flare Swivel

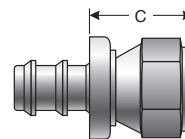

Description	Hose ID	Thread	C		Wt. Per Ea	Std. Pack	Stock or MOQ (ea)	Gates Item No.	List Price Per Ea
	(in)		(in)	(mm)	(lbs)				
4LOC-4RFJSX	1/4	7/16-20	.75	19.1	.04	1	Stock	7250-04715	\$4.06
4LOC-5RFJSX	1/4	1/2-20	.78	19.8	.04	1	Stock	7250-04725	\$5.15
5LOC-5RFJSX*	5/16	1/2-20	.81	20.6	.04	1	Stock	7250-04735	\$9.21
6LOC-5RFJSX	3/8	1/2-20	.81	20.6	.06	1	Stock	7250-04745	\$8.43
6LOC-8RFJSX	3/8	3/4-16	.97	24.6	.13	1	Stock	7250-18305	\$6.80
8LOC-8RFJSX	1/2	3/4-16	.97	24.6	.25	1	Stock	7250-04755	\$8.86
8LOC-10RFJSX	1/2	7/8-14	1.00	25.4	.13	1	Stock	7250-18315	\$11.11
10LOC-10RFJSX	5/8	7/8-14	1.00	25.4	.30	1	Stock	7250-04765	\$16.01
12LOC-10RFJSX	3/4	7/8-14	1.00	25.4	.20	1	Stock	7250-04775	\$18.07

\*Steel

AGRICULTURE
AIR BREATHING
AIR DUCT
AIR AND MULTI-PURPOSE
CHEMICAL
FOOD AND BEVERAGE
MARINE AND ENGINE
MATERIAL HANDLING
MINING
OILFIELD
PETROLEUM
PRESSURE WASH AND WASHDOWN
STEAM
WATER
CLAMPS
<b>COUPLINGS AND FERRULES</b>
HOSE FINDER
CHEMICAL RESISTANCE TABLE

## HOW TO USE THE COUPLINGS SECTION

NOTE: Because the hose/coupling interface is critical to hose assembly performance, always follow the specific instructions of hose and coupling manufacturers regarding the match of hose/fittings and assembly procedures. Trained personnel using proper tools and procedures should make hose assemblies. Failure to follow hose and couplings manufacturers' instructions or failure to use trained personnel might be dangerous and could result in damage to property and serious bodily injury.

Couplings are designated by Numbers, and are described as to construction and source. Adapters and fittings are available for special applications.

The proper clamp size should be selected carefully, since many clamps will fit only one hose size or a narrow range of sizes. For certain critical fluids, specific couplings are used, as follows:

### Critical Applications

1. Use only the couplings recommended in this catalog for conveying:

- Steam**
- LP Gas**
- Corrosive Chemicals**
- Edible Products**
- Petroleum Products**

2. For conveying flammable fluids, use couplings made of nonsparking materials, such as brass or aluminum.
3. For ground fueling of aircraft, use certified coupled assemblies only.

**When you have selected a hose from the Hose Section, you will have found one or more coupling recommendations for that hose. The following procedure will help you make the final selection:**

- A. If more than one coupling is recommended, make a final selection for type of coupling on basis of cost, sizes available, thread type available and application.
- B. Determine how the coupling is to be fastened to the hose – crimp sleeve, ferrule, band or clamp.

AGRICULTURE
AIR BREATHING
AIR DUCT
AIR AND MULTI-PURPOSE
CHEMICAL
FOOD AND BEVERAGE
MARINE AND ENGINE
MATERIAL HANDLING
MINING
OILFIELD
PETROLEUM
PRESSURE WASH AND WASHDOWN
STEAM
WATER
CLAMPS
<b>COUPLINGS AND FERRULES</b>
HOSE FINDER
CHEMICAL RESISTANCE TABLE

## Coupling Installation

**Before making any hose assembly, check these general instructions and precautions:**

1. **Square Ends**—Before attaching a coupling to the hose, make sure the end is cut square. This will help prevent leakage of the coupling.
2. **Proper Fit of Ferrules and Clamps**—This is important. Make sure you are using the correct sizes for the hose being coupled. Never buff the cover, except when specified for certain hydraulic hose couplings, and you should not enlarge the hose tube in any way to make the coupling insert fit. Occasionally, a nipple pusher tool will be helpful in pushing the insert into the hose.
3. **Installation Lubricants**—Use of lubricants on coupling inserts and ferrules will simplify coupling installation and reduce possibility of damage to the hose. Some lubricants to use are water, soap solution or Lactol. Or, you can use a solution of glycerin and alcohol made up of one (1) part glycerin and 15 parts wood alcohol by volume.
4. **Appearance of the Hose Assembly**—A properly installed coupling significantly improves customer acceptance of the product. It also provides added assurance of satisfactory service and safety of assembly.
5. **Seal the Ends**—Where the hose is intended for use in petroleum transfer applications and hose ends will be exposed after couplings are attached, apply a sufficient amount of quality Neoprene cement or shellac to seal the ends.

**NOTE: Refer to NAHAD Industrial Hose Assembly Guidelines for installation information and additional general information.**

AGRICULTURE
AIR BREATHING
AIR DUCT
AIR AND MULTI-PURPOSE
CHEMICAL
FOOD AND BEVERAGE
MARINE AND ENGINE
MATERIAL HANDLING
MINING
OILFIELD
PETROLEUM
PRESSURE WASH AND WASHDOWN
STEAM
WATER
CLAMPS
<b>COUPLINGS AND FERRULES</b>
HOSE FINDER
CHEMICAL RESISTANCE TABLE

## Pipe Thread Usage

There are several terms or abbreviations which have come into common use for denoting pipe threads. Some of these are:

Iron Pipe Threads

IPT

Tapered IPT

Straight IPT

IP—S

IP-T

NPT

These may be satisfactory for general reference, but since there are several types of pipe thread, it is best to use the notations as given by a recognized standard (ANSI B2.1). The types in this standard which are used with industrial hose couplings are listed later in this section.

Compatibility of threads and method of sealing determine which type of thread is to be used.

An NPT male and female form a pressure-tight joint, and usually some type of sealing compound is placed on the threads. NPTF threads are similar in that the seal is made by tight fit between the threads. However the fit is close enough that a sealing compound is not needed.

NPSM threads are used for either male or female fittings, but the seal is formed by compressing a packing or by metal contact between chamfers on the male and female. Size range is from 1/4" through 6" nominal pipe I.D.

NPSH threads are similar to NPSM threads but are used mostly for fire hose or special couplings. Size range is from 1/2" through 2" nominal pipe I.D. The seal is made by compressing packing.

GHT, garden hose threads, are a form of NPSH threads used on water hose. There is only one basic size of thread, 3/4 - 1 1/2. It is not compatible with 3/4-14NPT, NPSH or NPSM threads.

Couplings which come in sets usually have a female with NPSM threads and washer; and a male with NPT or NPSM threads.

Long shank couplings and pin lug couplings are examples where the male has NPSM threads. Reusable petroleum couplings are examples of sets in which the male has NPT threads.

Standard brass inserts have NPTF males and solid females and NPSM swivel females. The seal is made by contact of chamfers or tight fit of threads.

Couplings for hydraulic hose have threads which may conform to the above descriptions. In addition, there are many other types peculiar to the hydraulic field. For a complete description of threads, identification, sizes, methods of sealing and other related data, see Hydraulic Hose Catalog #35093.

### Combinations of Pipe Threads that Are Compatible:

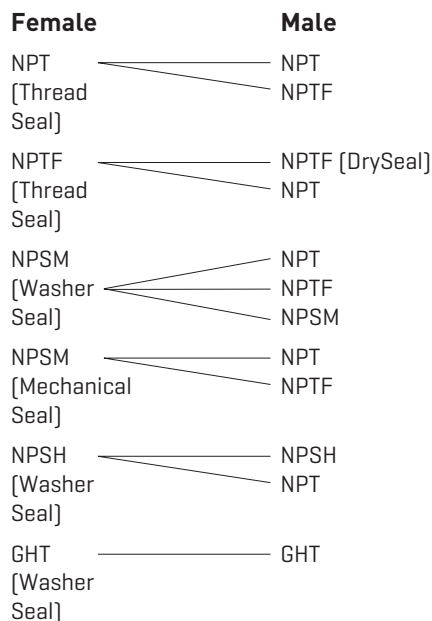

AGRICULTURE
AIR BREATHING
AIR DUCT
AIR AND MULTI-PURPOSE
CHEMICAL
FOOD AND BEVERAGE
MARINE AND ENGINE
MATERIAL HANDLING
MINING
OILFIELD
PETROLEUM
PRESSURE WASH AND WASHDOWN
STEAM
WATER
CLAMPS
<b>COUPLINGS AND FERRULES</b>
HOSE FINDER
CHEMICAL RESISTANCE TABLE

Pipe Thread Usage (continued)

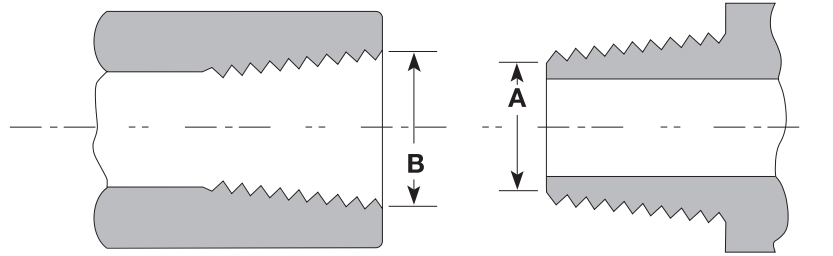

Chart No. 1

American Standard Pipe Threads (ANSI B2.1)

Nominal Pipe Size (In.)	Pipe O.D. (In.)	Threads Per Inch	NPT & NPTF	NPT	NPSM**		
			*Ext. Thrd. Pitch (A) Diameter	*Int. Thrd. Pitch (B) Diameter	Ext. Thrd. Max. Major Diameter	Int. Thrd. Min. Minor Diameter	
1/8	.405	27	0.36351	0.37476	0.409	0.362	
1/4	.504	18	0.47739	0.48989	0.541	0.470	
3/8	.675	18	0.61201	0.62701	0.678	0.607	
	1/2	.840	14	0.75843	0.77843	0.844	0.753
3/4	1.050	14	0.96768	0.98887	1.054	0.964	
1	1.315	11-1/2	1.21363	1.23863	1.318	1.208	
	1-1/4	1.660	11-1/2	1.55713	1.58338	1.663	1.553
	1-1/2	1.900	11-1/2	1.79609	1.82234	1.902	1.792
2	2.375	11-1/2	2.26902	2.29627	2.376	2.265	
	2-1/2	2.875	8	2.71593	2.76216	2.877	2.718
3	3.500	8	3.34062	3.38850	3.503	3.344	
	3-1/2	4.000	8	3.83750	3.88881	4.003	3.845
	4	4.500	8	4.33438	4.38712	4.502	4.343
5	5.563	8	5.39073	5.44929	5.564	5.405	
	6	6.625	8	6.44609	6.50597	6.620	6.462

\* Dimensions A & B shown on the sketch above

\*\* Loose Fitting

Chart No. 2

American Standard Pipe Threads for Hose Couplings and Nipples

	Nominal Size (Hose I.D.) (In.)	Threads Per Inch	Pitch	Depth of Thread	Major Diam. Min.
GHT	1/2, 5/8, 3/4	11-1/2	Coupling 0.08696	0.05648	1.0725
	1/2, 5/8, 3/4	11-1/2	Nipple 0.08696	0.05648	1.0625
NPSH	1/2	14	0.07143	0.04639	0.8323
	3/4	14	0.07143	0.04639	1.0428
	1	11-1/2	0.08696	0.05648	1.3051
	1-1/4	11-1/2	0.08696	0.05648	1.6499
	1-1/2	11-1/2	0.08696	0.05648	1.8888
	2	11-1/2	0.08696	0.05648	2.3628
NPSH	Male				Major Diam. Max.
	1/2	14	0.07143	0.04639	0.8248
	3/4	14	0.07143	0.04639	1.0353
	1	11-1/2	0.08696	0.05648	1.2951
	1-1/4	11-1/2	0.08696	0.05648	1.6399
	1-1/2	11-1/2	0.08696	0.05648	1.8788
	2	11-1/2	0.08696	0.05648	2.3528

## Couplings and Ferrules

### 1 Long Shank

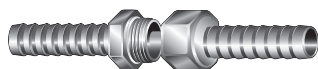

**Description:** Cast brass, serrated shank, set has hex male and hex swivel female couplings, with a washer seal. Threads are GHT or NPSM.

**Sources:** A P G  
Dixon Valve & Coupling Co.  
Seal-Fast, Inc.

### 2 Lightweight Water Hose

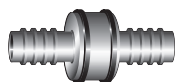

**Description:** Spun or wrought brass serrated shank, round swivel female and solid male, both GHT, washer seal.

**Sources:** Dixon Brass  
L.R. Nelson Corp.

### 3 Cast Brass or Zinc Short Shank



**Description:** Cast brass, serrated shank, hex swivel female with washer, solid male, GHT threads, 3/4-11-1/2.

**Sources:** A P G  
Seal-Fast, Inc.

### 4 Machined Brass Short Shank



**Description:** Machined brass, serrated shank. Each set has round swivel female and solid male, GHT, washer seal. Octagon nut male and female.

**Sources:** Anderson Fittings  
A P G  
Campbell Fittings, Inc.  
Dixon Brass  
Lenz, Inc.

### 5 Brass Pin Lug

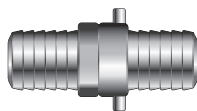

**Description:** Cast brass shank and swivel, shank is serrated. NPSM threads in female and male, with washer seal. Sizes under 3" have lugs on female only.

**Sources:** A P G  
Dixon Valve & Coupling Co.  
PT Coupling Co.

### 6 Malleable Iron Pin Lug

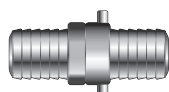

**Description:** Malleable iron shank and swivel with serrated shank, cadmium plated. NPSM threads in male and female, washer seal. Pin lugs on female Only.

**Sources:** A P G  
Dixon Valve & Coupling Co.  
PT Coupling Co.  
Seal-Fast, Inc.

### 7 Combination Nipple

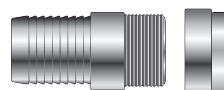

**Description:** Swaged steel with scored or serrated shank, NPT threads same nominal size as I.D. of hose. Special plastic materials available.

**Sources:** A P G  
Band-It-IDEX, Inc.  
Campbell Fittings, Inc.  
Dixon Valve & Coupling Co.  
Martin Brass Works, Inc.  
PT Coupling Co.  
Seal-Fast, Inc.

### 8 Tri-Lokt

**Description:** Machined steel insert, male NPT threads only.

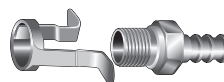

Held in place with steel yoke and Band-It Jr. clamps. Insert is reusable — can be reinstalled with new yoke and clamps.

**Source:** Band-It-IDEX, Inc.

### 10 Single or Double Bolt Malleable Iron Clamp



**Description:** Cast malleable iron, cadmium plated.

**Source:** Dixon Valve & Coupling Co.

### 14 Interlocking, Ground Joint

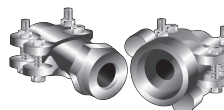

**Description:** Malleable iron swivel. Inserts and spud may be either steel or malleable iron. All parts are cadmium plated. Male and female threads both NPT with same nominal size as hose I.D. Ground joint between spud and female insert. Available with 2- and 4-bolt clamps.

**Sources:** A P G  
Dixon Valve & Coupling Co.  
PT Coupling Co.  
Seal-Fast, Inc.

### 15 Interlocking, Washer Joint

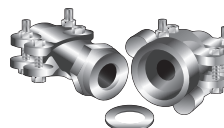

**Description:** Malleable iron swivel. Insert and spud may be either malleable iron or steel. All parts are cadmium plated. Female thread in spud is NPT with same nominal size as hose I.D. Washer joint between insert and spud. Available with 2- and 4-bolt clamps.

**Source:** Campbell Fittings, Inc.  
Dixon Valve & Coupling Co.  
PT Coupling Co.

AGRICULTURE

AIR BREATHING

AIR DUCT

AIR AND MULTI-PURPOSE

CHEMICAL

FOOD AND BEVERAGE

MARINE AND ENGINE

MATERIAL HANDLING

MINING

OILFIELD

PETROLEUM

PRESSURE WASH AND WASHDOWN

STEAM

WATER

CLAMPS

COUPLINGS AND FERRULES

HOSE FINDER

CHEMICAL RESISTANCE TABLE



## Couplings and Ferrules

AGRICULTURE
AIR BREATHING
AIR DUCT
AIR AND MULTI-PURPOSE
CHEMICAL
FOOD AND BEVERAGE
MARINE AND ENGINE
MATERIAL HANDLING
MINING
OILFIELD
PETROLEUM
PRESSURE WASH AND WASHDOWN
STEAM
WATER
CLAMPS
COUPLINGS AND FERRULES
HOSE FINDER
CHEMICAL RESISTANCE TABLE

### 18 Universal Quick Acting

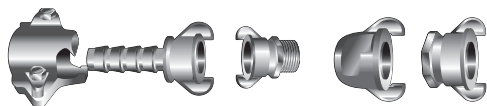

**Description:** Cast malleable iron with cadmium plate, cast bronze. Washer seal between two quick-acting heads. Several types of heads are available, but all have same-size attaching heads regardless of hose size. Fingers lock together with quarter-turn rotation.

**Sources:** A P G  
Campbell Fittings, Inc.  
Dixon Valve & Coupling Co.  
PT Coupling Co.  
Seal-Fast, Inc.

### 19 Standard Air Hose

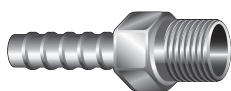

**Description:** Machined brass, with serrated shank, NPTF threads on hex solid male and on hex solid female, and NPSM threads on hex swivel female.

**Sources:** Anderson Fittings  
A P G  
Dixon Brass  
Dixon Valve & Coupling Co.  
Lenz, Inc.  
National Coupling Co.  
Plews-Schrader

### 20 Ferrules



**Description:** All stock ferrules are plain drawn brass.

**Sources:** Anderson Fittings  
Dixon Brass  
Dixon Valve & Coupling Co.  
Jagemann Stamping Co.  
Plews-Schrader  
Truex, Inc.  
Winzler Stamping Co.

### 21 Preformed Band Clamps



**Description:** A preformed ring clamp of rust-resistant carbon steel or Type 201 stainless steel. Also available in Type 316 stainless steel, and non-sparking silicon bronze. Available in 100-foot rolls, carbon steel or stainless.

**Sources:** Band-It-IDEX, Inc.  
Fast-Lok Hose Clamps  
PT Coupling Co.

### 23 Reusable Gasoline Pump

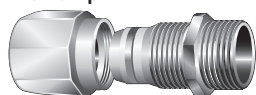

**Description:** Various materials; Two piece construction. Male NPT or IPT threads [also see coupling 47].

**Sources:** PT Coupling Co.  
Serv-All Die and Tool Co.

### 24 Permanent Gasoline Pump Hose

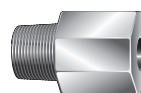

**Description:** Various materials; One piece construction. Male NPT or IPT threads.

**Sources:** Serv-All Die and Tool Co.

### 26 Internal Expansion-Brass

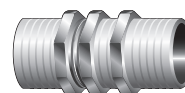

**Description:** Body is forged brass. Ferrule is cold-drawn copper alloy. Male coupling has NPT threads, female swivel coupling has NPSH threads. All threads same nominal size as hose I.D. except 1-3/8" I.D. size which has 1-1/2 - 11-1/2 threads. On 1-1/2" and larger sizes, female has special tightening lugs.

**Sources:** Dixon Valve & Coupling Co.

ProGrip Co.  
United Metal Industries, Inc.

### Ferrules for Internal Expansion

**Sources:** Dixon Valve & Coupling Co.  
PT Coupling Co.  
United Metal Industries, Inc.



### 34 Stainless Steel Nipples

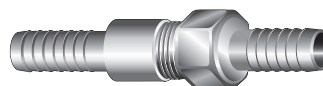

**Description:** Type 316 stainless steel, with serrated shank, solid male NPT threads, hex swivel female, NPSM threads, washer seal. Threads same nominal size as hose I.D.

**Sources:** Dixon Valve & Coupling Co.  
Martin Brass Works, Inc.

### 35 Four-Finger Boss Clamp

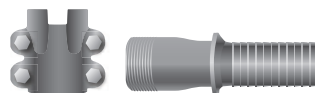

**Description:** Plated iron, stainless steel and brass clamps in 2, 3 and 4 gripping finger configurations. Corresponding stems come in NPT or beveled ends. Available in 2-, 4- and 6-bolt clamps. Follow manufacturer's recommendations for bolt torque and tightening sequence procedures.

**Sources:** Dixon Valve & Coupling Co.

### 36 Sandblast

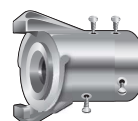

**Description:** Sand blast couplings are designed for use on sand blast hose. Couplings are supplied with screws.

**Sources:** A P G  
Campbell Fitting, Inc.  
Dixon Valve & Coupling Co.  
PT Coupling Co.  
Seal-Fast, Inc.

## Couplings and Ferrules

### 47 Reusable Fuel Oil

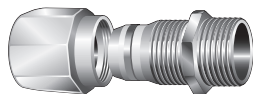

**Description:** This coupling is similar to 23 except it has a brass finish, instead of chrome plating. Male NPTF threads, female NPSM threads, washer seal. Threads same nominal size as hose I.D., except as noted.

**Sources:** United Metal Industries, Inc.

### 48 Band-It Nipples

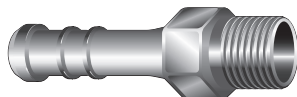

**Description:** Machined steel hex inserts, rust-resistant blued finish, serrated shank, male NPT threads.

**Source:** Band-It-IDEX, Inc.

### 49 Quick-Connecting

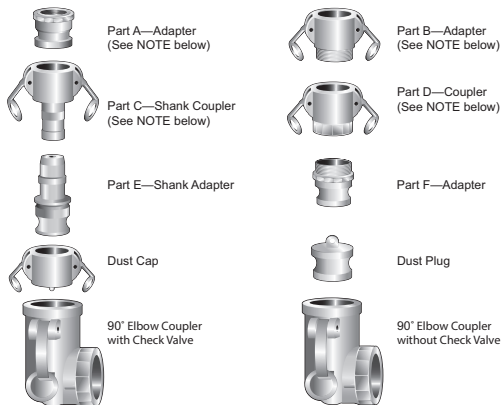

**Description:** The basic parts of this coupling are a bronze female shank coupler and a male adapter, which have a washer seal but no threads. These two parts fit snugly together and are held in place by two cams on the female shank coupler which rotate against a groove in the male adapter. This allows the coupling to be connected or disconnected very quickly. Adapters and dust caps are available as shown below. Standard materials are bronze or aluminum.

**Sources:** A P G  
Banjo Corporation  
Campbell Fittings, Inc.  
Dixon Valve & Coupling Co.  
Ever-Tite Coupling  
OPW Engineered Systems  
PT Coupling Co.  
Scully Signal Co.  
Seal-Fast, Inc.

**NOTE:** Part A and Part D have female NPT threads. Part B and Part F have male NPT threads. Above threads have same nominal size as hose I.D. The above couplers and adapters are used to convert threaded-end couplings to quick connect.

### 61 Center Punch



**Description:** Open-end band or preformed band of rust-resistant steel. Also available in stainless steel.

**Sources:** Fast-Lok Hose Clamps  
PT Coupling Co.

### 71 Permanent Swaged or Crimped

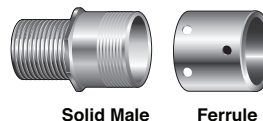

**Description:** API or NPT threads on connecting end of stem for easy flange attachment. Strong collar to anchor ferrule to stem. Electroplated steel. Also available in stainless steel, brass and other special metals.

**Sources:** Campbell Fittings, Inc. (Max. 1500 psi)  
Dixon Valve & Coupling Co.  
George Myer Company, Inc.  
PT Coupling Co.

### 72 Gates Power Crimp®

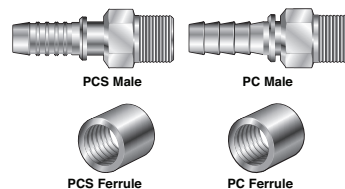

**Description:** API or NPT threads on connecting end of stem for easy flange attachment. Strong collar to anchor ferrule to stem. Electroplated steel. Also available in stainless steel.

**Sources:** Gates Corp.

### 73 Permanent Swaged or Crimped

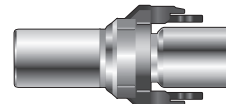

Cam and Groove

**Description:** NPT threads on connecting end of stem for easy flange attachment. Strong collar to anchor ferrule to stem. Electroplated steel. Also available in stainless steel, brass and other special metals.

**Sources:** A P G  
Dixon Valve & Coupling Co.  
PT Coupling Co.

### 74 Gates MegaCrimp®

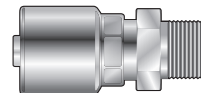

**Description:** NPT threads on connecting end of stem for easy flange attachment. Tuffcoat plated steel. The "C" insert assures an even distribution of crimping forces to form a concentric seal.

**Sources:** Gates Corp.

### 75 Gates GLX®

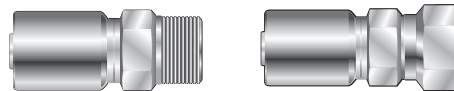

Male Pipe

Female Swivel

**Description:** One piece staked ferrule design. Smooth ferrule ID designed for textile reinforced hoses. Male and female pipe, female JIC 37° flare swivel and male and female SAE 45° flare terminations. TuffCoat™ plated steel for 400 hour red rust corrosion protection (SAE-J516 and ASTM-B-117 salt spray conditions).

**Sources:** Gates Corp.

AGRICULTURE

AIR BREATHING

AIR DUCT

AIR AND MULTI-PURPOSE

CHEMICAL

FOOD AND BEVERAGE

MARINE AND ENGINE

MATERIAL HANDLING

MINING

OILFIELD

PETROLEUM

PRESSURE WASH AND WASHDOWN

STEAM

WATER

CLAMPS

COUPLINGS AND FERRULES

HOSE FINDER

CHEMICAL RESISTANCE TABLE

## Couplings and Ferrules

AGRICULTURE
AIR BREATHING
AIR DUCT
AIR AND MULTI-PURPOSE
CHEMICAL
FOOD AND BEVERAGE
MARINE AND ENGINE
MATERIAL HANDLING
MINING
OILFIELD
PETROLEUM
PRESSURE WASH AND WASHDOWN
STEAM
WATER
CLAMPS
<b>COUPLINGS AND FERRULES</b>
HOSE FINDER
CHEMICAL RESISTANCE TABLE

### 76 Permanent Crimped Steam

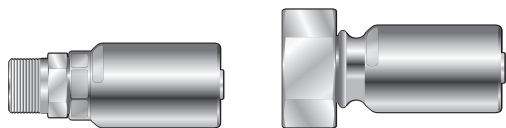

Male Pipe

Female Ground Joint

**Description:** Permanently crimped steam hose couplings – Female Viton® Seal Ground Joint or Male NPT Thread. Precision metal to metal contact with a Viton seal provides leak-free performance. Streamlined permanently crimped ferrule eliminates protruding bolts that require retightening and can catch on equipment or cause injury.

**Sources:** Campbell Fittings, Inc.

### 78 Crimp Sleeves



**Description:** Available in plated steel, 316 stainless steel and aluminum. Suitable for replacing band clamps when using pin lug, combination nipple or cam and groove stems. Working pressures are determined by the type of couplings and hose used.

**Sources:** APG  
Campbell Fittings, Inc.  
Dixon Valve & Coupling Co.  
PT Coupling Co

### 79 Holedall Permanent Swaged – Long Style

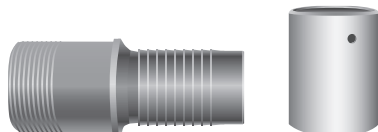

**Description:** Patented Holedall couplings include a Holedall stem and specially engineered ferrule. This multi-purpose, high-pressure coupling system requires no bolts and results in a clean coupling with no protrusions.

**Sources:** Dixon Valve & Coupling Co.

### 80 Gates GSP

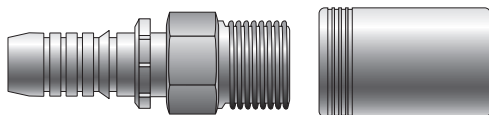

**Description:** Two piece, no skive design engineered for high-pressure, high-impulse applications. TuffCoat™ plated steel for 400 hour red rust corrosion protection (SAE-J516 and ASTM-B-117 salt spray conditions).

**Sources:** Gates Corp.

### 81 Gates GL

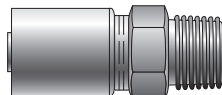

**Description:** One piece staked ferrule design. Smooth ferrule ID designed for textile and helical reinforced transfer hoses. Male and female pipe, male and female JIC 37° flare and male and female SAE 45° flare terminations. TuffCoat® plated steel for 400 hour red rust corrosion protection (SAE-J516 and ASTM-B-117 salt spray conditions).

**Sources:** Gates Corp.

### 82 Gates SS

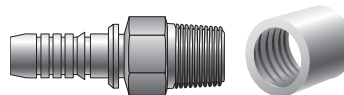

**Description:** Two piece, no skive design. Made of stainless steel for high corrosion resistance

**Sources:** Gates Corp.

### 84 Dixon Bauer

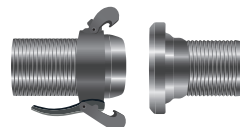

**Description:** Dixon™ combination nipple style hose shank machined from Schedule 40 pipe. Recommended for use with steel King Crimp™ sleeves. All components are galvanized

**Sources:** Dixon Valve & Coupling Co.

### 88 Brass Male NPT x Hose Barb

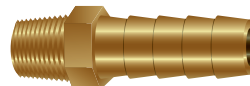

**Description:** All standard hose fittings are intended for use with hose clamps or crimped ferrules.

**Sources:** Dixon Valve & Coupling, Co.

### 89 Brass Ferrules



**Description:** Stamped brass ferrules to be used with brass hose barbs.

**Sources:** Dixon Valve & Coupling, Co.

## Couplings and Ferrules

**Anderson Fittings**  
Oak Forrest, IL 60452  
(800) 323-5284  
**4 19 20**

**A P G**  
Houston, TX 77020  
(800) 888-5223  
**1 3 4 5 6 7 14 18 19 36 49 73 78**

**Banjo Corporation**  
Crawfordsville, IN 47933  
(765) 362-7367  
**49**

**Band-IT-IDEX, Inc.**  
Denver, CO 80216  
(303) 320-4555  
**7 8 21 22 48**

**Campbell Fittings, Inc.**  
Boyertown, PA 19512  
(800) 367-3678  
**4 7 15 18 36 71 76 78**

**Dixon Brass**  
A Dixon Company  
Westmont, IL 60559  
(800) 323-4440  
**2 4 19 20**

**Dixon Valve & Coupling Co.**  
Chestertown, MD 21620  
(800) 355-1991  
**1 5 6 7 10 14 15 18 19 20 26 35  
49 71 73 78 79**

**Fast-Lok Hose Clamps**  
Division of Deco Products Co.  
Decorah, IA 52101  
(800) 327-9751  
**21 22 61**

**JC Gadd Company**  
Denver, CO 80227  
(303) 744-3345  
**3 23 24 28**

**George Myer Company, Inc.**  
Houston, TX 77023  
(800) 600-3074  
**71**

**Jagemann Stamping Company**  
Manitowoc, WI 54221  
(888) 337-7853  
**20**

**Lenz, Inc.**  
Dayton, OH 45401  
(937) 277-9364  
**4 19**

**Martin Brass Works, Inc.**  
Jamaica, NY 11433  
(718) 523-3146  
**7 34**

**National Coupling Co.**  
Stafford, TX 77477  
(281) 499-2583  
**19**

**LR Nelson Corp.**  
Peoria, IL 61615  
(309) 690-2200  
**2**

**OPW Engineered Systems**  
Lebanon, OH 45036  
(800) 547-9393  
**49**

**PT Coupling Co.**  
**ProGrip Co.**  
**Punch-Lok Co.**  
Enid, OK 73701  
(800) 654-0320  
**5 6 7 14 15 18 21 22 23 25 26  
36 49 61 71 73 78**

**Plews-Schrader**  
Division of Tomkins Ind. &  
Auto  
Dixon, IL 61021  
(815) 288-3344  
**19 20**

**Scully Signal Co.**  
Wilmington, MA 01887  
(800) 272-8559  
**49**

**Seal-Fast, Inc.**  
Houston, TX 77220  
(800) 231-0734  
**1 3 6 7 14 18 36 49**

**Serv-All Die and Tool Co.**  
Crystal Lake, IL 60014  
(815) 459-2900  
**23 24 28**

**Truex, Inc.**  
Pawtucket, RI 02861  
(800) 458-7839  
**20**

**United Metal Industries, Inc.**  
New Hyde Park, NY 11040  
(800) 359-6801  
**25 26 27 47**

**Winzler Stamping Company**  
Montpelier, OH 43543  
(419) 485-3147  
**20**

AGRICULTURE
AIR BREATHING
AIR DUCT
AIR AND MULTI-PURPOSE
CHEMICAL
FOOD AND BEVERAGE
MARINE AND ENGINE
MATERIAL HANDLING
MINING
OILFIELD
PETROLEUM
PRESSURE WASH AND WASHDOWN
STEAM
WATER
CLAMPS
<b>COUPLINGS AND FERRULES</b>
HOSE FINDER
CHEMICAL RESISTANCE TABLE

AGRICULTURE
AIR BREATHING
AIR DUCT
AIR AND MULTI-PURPOSE
CHEMICAL
FOOD AND BEVERAGE
MARINE AND ENGINE
MATERIAL HANDLING
MINING
OILFIELD
PETROLEUM
PRESSURE WASH AND WASHDOWN
STEAM
WATER
CLAMPS
COUPLINGS AND FERRULES
HOSE FINDER
CHEMICAL RESISTANCE TABLE

## PROPER HOSE SELECTION

### Explanation of Column Headings

- Hose I.D.** — This is the nominal hose inside diameter in inches (Refer to ARPM Tolerances page).
- Hose Name** — This is the hose identification shown in the catalog. For some special hoses, it may be a number, not a name.
- Rated Working Pressure (psi)** — This is the design working pressure and is based on a certain percentage of the hose burst value. It varies with hose type and intended application.
- Vacuum (In. Hg)** — This is the vacuum rating of the hose when used in vacuum applications at ambient temperatures, and not bent beyond the minimum bend radius
- Hose O.D.** — The outside diameter (Refer to ARPM Tolerances page).
- Tube** — For reference, the Gates rubber type identification is given and the color used on that particular hose. Refer to Characteristics and Resistance Information for Hose Tube and Cover Compounds page for a description of these stocks.
- Cover** — Same information for tube stock.
- Hose Weight** — This is approximate measurement per current specification.
- Minimum Bend Radius** — This is the smallest radius in inches around which a hose can be bent without over stressing components, without collapsing the hose wall and without substantially reducing fluid flow.
- Hose Temperature Range** — Includes maximum and minimum temperatures of each hose listed.

11. **Hose Category** — This is a listing of hose types as indicated in the Table of Contents of the Industrial Hose Products #39496-000. Most hoses are not limited to these applications only.

### How to Select a Hose From the Data Pages

#### Example 1

**Given: A customer wants a 3/4" I.D. x 20" hose to handle air or water and general purpose applications. Temperatures are ambient, a pressure rating up to 300 psi is required and it must have textile reinforcement with a high oil resistant tube.**

Turn to Hose Finder Data Pages for the listing of 3/4" I.D. hoses. In the Rated Working Pressure column, you will find the 300 psi figures. NOTE: Several hoses have a 300 psi rating or higher. But, the ones with textile reinforcement and high oil resistance that are multi-purpose are Plant Master® XTreme™ hoses. All of these hoses could be suitable for the application. Refer to corresponding catalog page number for specific hose details and coupling recommendations.

#### Example 2

**Given: 6" x 50" dry powder food-grade transfer hose is needed. The hose requirements are: full vacuum, 50 psi and a temperature of 100°F.**

Turn to Hose Finder Data Pages for the listing of 6" I.D. hoses. In the Rated Working Pressure column, you will find the 50 psi rating or higher. The two hoses with 50 psi and full vacuum ratings and suitable for bulk food transfer are Food Master™ Dry Goods and Food Master™ Oils & Dairy. Refer to corresponding catalog page number for specific hose details and coupling recommendations.

## Hose Finder

Hose I.D. (in)	Name	Rated W.P. (psi)	Vacuum (In. Hg.)	Hose O.D. (in)	Tube Type	Cover Type	MBR (in)	Wt. (lbs/ft)	Temp Min. (°F)	Temp Max. (°F)	Hose Categories	Catalog Page No.
7/64	Windshield Washer and Vacuum Tubing	25	24.0	.22	P	—	1.5	1.00	-40°F	+257°F	Marine and Engine	99
1/8	Food Master® PVC (20-65) Clear	65	—	.20	G	G	—	.02	-25°F	+150°F	Food and Beverage	78
5/32	4219G Fuel Line (35-50)	50	24.0	.36	C	C2	2.0	.05	-40°F	+257°F	Marine and Engine	97
5/32	Windshield Washer and Vacuum Tubing	25	24.0	.31	P	—	1.5	2.24	-40°F	+257°F	Marine and Engine	99
3/16	4219BG Barricade® Fuel Hose (35-50)	50	24.0	.41	J	C	2.17	.07	-40°F	+212°F	Marine and Engine	83
3/16	4219G Fuel Line (35-50)	50	24.0	.41	C	C2	3.0	.07	-40°F	+257°F	Marine and Engine	97
3/16	Food Master® PVC (20-65) Clear	50	—	.25	G	G	—	.03	-25°F	+150°F	Food and Beverage	78
3/16	Food Master® PVC (20-65) Clear	60	—	.38	G	G	—	.04	-25°F	+150°F	Food and Beverage	78
3/16	LPG Vapor 125	125	30.0	.44	C	A	2.0	.08	-30°F	+150°F	Petroleum	149
3/16	Plant Master® XTreme™ (250-315)	250	30.0	.45	C	C2	2.0	.07	-40°F	+212°F	Air and Multi-Purpose	51
7/32	Windshield Washer and Vacuum Tubing	25	24.0	.42	P	—	2.0	3.66	-40°F	+257°F	Marine and Engine	99
1/4	4219BF Barricade® Fuel Injection Fuel Hose 225	225	24.0	.50	J	C	2.56	.10	-40°F	+275°F	Marine and Engine	84
1/4	4219BG Barricade® Fuel Hose (35-50)	50	24.0	.50	J	C	2.56	.11	-40°F	+212°F	Marine and Engine	83
1/4	4219G Fuel Line (35-50)	50	24.0	.50	C	C2	3.0	.10	-40°F	+257°F	Marine and Engine	97
1/4	4219M Marine Master™ Fuel Line 40	40	28.0	.64	C	A	2.5	4.73	-40°F	+212°F	Marine and Engine	96
1/4	Ag Master™ (200-250)	200	30.0	.50	P	P	3.0	.09	-40°F	+200°F	Agriculture	38
1/4	Air Master™ Respirator 500	500	—	.51	C	A	3.0	.13	-20°F	+120°F	Air Breathing	45
1/4	Air Master™ SCUBA 500	500	—	.51	C	A	2.7	.09	-20°F	+120°F	Air Breathing	44
1/4	C5M Marine Fuel Line Hose	500	24.0	.58	C	C2	1.3	.21	-4°F	+212°F	Marine and Engine	95
1/4	Chem Master™ Paint Spray (500-750)	500	30.0	.52	Z	A	3.0	.09	-40°F	+150°F	Chemical	67
1/4	Clean Master™ Pressure Wash (3500-4000)	3500	30.0	.53	C	C2	2.0	.15	-40°F	+250°F	Pressure Wash and Washdown	153
1/4	Clean Master™ Pressure Wash (4000-6000)	6000	30.0	.59	C	C2	2.0	.25	-40°F	+250°F	Pressure Wash and Washdown	154
1/4	Clean Master™ Pressure Wash Assemblies	3000	30.0	.48	C	C2	2.0	5.80	-40°F	+250°F	Pressure Wash and Washdown	155
1/4	Food Master® PVC (20-65) Clear	55	—	.38	G	G	—	.03	-25°F	+150°F	Food and Beverage	78
1/4	Food Master® PVC (20-65) Clear	60	—	.50	G	G	—	.08	-25°F	+150°F	Food and Beverage	78
1/4	Food Master® PVC Clear Tubing (75-250) Braid	250	—	.47	G	G	—	.07	-10°F	+130°F	Food and Beverage	79
1/4	LP350	350	30.0	.58	A	A	3.0	.14	-40°F	+180°F	Petroleum	148
1/4	LPG Vapor 125	125	30.0	.53	C	A	3.0	.11	-30°F	+150°F	Petroleum	149
1/4	MIL Low Pressure Fuel & Oil Hose	250	—	.59	A	A	3.0	.15	-40°F	+250°F	Marine and Engine	85
1/4	Plant Master® (150-200)	200	30.0	.50	P	P	3.0	.08	-40°F	+200°F	Air and Multi-Purpose	58
1/4	Plant Master® 250 Black	250	30.0	.50	P	P	3.0	.08	-40°F	+200°F	Air and Multi-Purpose	56
1/4	Plant Master® 250 Black	250	30.0	.62	P	P	3.0	.08	-40°F	+200°F	Air and Multi-Purpose	56
1/4	Plant Master® 250 Colors	250	30.0	.50	P	P	3.0	.08	-40°F	+200°F	Air and Multi-Purpose	57
1/4	Plant Master® 250 Colors	250	30.0	.62	P	P	3.0	.08	-40°F	+200°F	Air and Multi-Purpose	57
1/4	Plant Master® 300	300	30.0	.53	P	P	3.0	.10	-40°F	+200°F	Air and Multi-Purpose	55
1/4	Plant Master® 300 NC	300	30.0	.62	P	P	3.0	.16	-20°F	+150°F	Air and Multi-Purpose	59
1/4	Plant Master® Plus (200-300)	250	30.0	.50	B1	D3	2.0	.09	-40°F	+200°F	Air and Multi-Purpose	54
1/4	Plant Master® Plus (200-300)	300	30.0	.57	B1	D3	2.0	.12	-40°F	+200°F	Air and Multi-Purpose	54
1/4	Plant Master® Plus 300 Lock-On	300	30.0	.54	C	A	3.0	.11	-20°F	+212°F	Air and Multi-Purpose	53
1/4	Plant Master® XTreme™ (250-315)	250	30.0	.50	C	C2	2.0	.09	-40°F	+212°F	Air and Multi-Purpose	51

AGRICULTURE

AIR BREATHING

AIR DUCT

AIR AND MULTI-PURPOSE

CHEMICAL

FOOD AND BEVERAGE

MARINE AND ENGINE

MATERIAL HANDLING

MINING

OILFIELD

PETROLEUM

PRESSURE WASH AND WASHDOWN

STEAM

WATER

CLAMPS

COUPLINGS AND FERRULES

HOSE FINDER

CHEMICAL RESISTANCE TABLE

## Hose Finder

	Hose I.D. (in)	Name	Rated W.P. (psi)	Vacuum (In. Hg.)	Hose O.D. (in)	Tube Type	Cover Type	MBR (in)	Wt. (lbs/ft)	Temp Min. (°F)	Temp Max. (°F)	Hose Categories	Catalog Page No.
AGRICULTURE													
AIR BREATHING													
AIR DUCT													
AIR AND MULTI-PURPOSE	1/4	Plant Master® XTreme™ (250-315)	315	30.0	.57	C	C2	2.0	.12	-40°F	+212°F	Air and Multi-Purpose	51
	1/4	Plant Master® XTreme™ 300 AR	300	30.0	.53	C	C4	2.0	.10	-40°F	+212°F	Air and Multi-Purpose	52
	1/4	Plant Master® XTreme™ 300 Lock-On Braid	300	27.9	.47	C	C2	3.0	.09	-40°F	+212°F	Air and Multi-Purpose	50
CHEMICAL	1/4	Plant Master® XTreme™ 325 Braid	325	30.0	.50	C	A	3.0	.09	-40°F	+212°F	Air and Multi-Purpose	48
	1/4	Plant Master® XTreme™ 501 AR	501	30.0	.57	C	C4	3.0	.12	-40°F	+212°F	Air and Multi-Purpose	49
FOOD AND BEVERAGE	1/4	Windshield Washer and Vacuum Tubing	25	24.0	.45	P	—	2.0	3.95	-40°F	+257°F	Marine and Engine	99
	5/16	4219BF Barricade® Fuel Injection Fuel Hose 225	225	24.0	.56	J	C	2.95	.11	-40°F	+275°F	Marine and Engine	84
MARINE AND ENGINE	5/16	4219BG Barricade® Fuel Hose (35-50)	50	24.0	.56	J	C	2.95	.11	-40°F	+212°F	Marine and Engine	83
	5/16	4219G Fuel Line (35-50)	50	24.0	.56	C	C2	3.0	.12	-40°F	+257°F	Marine and Engine	97
	5/16	4219M Marine Master™ Fuel Line 40	40	28.0	.70	C	A	3.0	5.08	-40°F	+212°F	Marine and Engine	96
	5/16	4230T Coolant Hose	75	25.0	.62	P	P	2.0	.15	-40°F	+257°F	Marine and Engine	91
MATERIAL HANDLING	5/16	Air Master™ SCUBA 500	500	—	.56	C	A	2.8	.01	-20°F	+120°F	Air Breathing	44
	5/16	C5M Marine Fuel Line Hose	500	24.0	.67	C	C2	1.3	.27	-4°F	+212°F	Marine and Engine	95
	5/16	Chem Master™ Paint Spray (500-750)	500	30.0	.59	Z	A	3.0	.11	-40°F	+150°F	Chemical	67
MINING	5/16	Food Master® PVC (20-65) Clear	50	—	.44	G	G	—	.04	-25°F	+150°F	Food and Beverage	78
	5/16	Food Master® PVC (20-65) Clear	60	—	.56	G	G	—	.10	-25°F	+150°F	Food and Beverage	78
OILFIELD	5/16	MIL Low Pressure Fuel & Oil Hose	250	—	.66	A	A	3.0	.17	-40°F	+250°F	Marine and Engine	85
	5/16	Plant Master® (150-200)	200	30.0	.53	P	P	3.0	.09	-40°F	+200°F	Air and Multi-Purpose	58
PETROLEUM	5/16	Plant Master® XTreme™ (250-315)	250	30.0	.56	C	C2	2.0	.11	-40°F	+212°F	Air and Multi-Purpose	51
	5/16	Plant Master® XTreme™ (250-315)	315	30.0	.67	C	C2	2.0	.16	-40°F	+212°F	Air and Multi-Purpose	51
PRESSURE WASH AND WASHDOWN	5/16	Plant Master® XTreme™ 325 Braid	325	30.0	.62	C	A	3.0	.13	-40°F	+212°F	Air and Multi-Purpose	48
	5/16	Windshield Washer and Vacuum Tubing	25	24.0	.50	P	—	2.5	1.74	-40°F	+257°F	Marine and Engine	99
STEAM	3/8	4219BF Barricade® Fuel Injection Fuel Hose 225	225	24.0	.62	J	C	3.35	.13	-40°F	+275°F	Marine and Engine	84
	3/8	4219BG Barricade® Fuel Hose (35-50)	50	24.0	.62	J	C	3.35	.12	-40°F	+212°F	Marine and Engine	83
	3/8	4219G Fuel Line (35-50)	50	24.0	.62	C	C2	4.0	.15	-40°F	+257°F	Marine and Engine	97
WATER	3/8	4219M Marine Master™ Fuel Line 40	40	28.0	.77	C	A	3.0	11.04	-40°F	+212°F	Marine and Engine	96
	3/8	4230T Coolant Hose	75	25.0	.69	P	P	2.5	.17	-40°F	+257°F	Marine and Engine	91
CLAMPS	3/8	Ag Master™ (200-250)	200	30.0	.66	P	P	3.0	.00	-40°F	+200°F	Agriculture	38
	3/8	Ag Master™ Spray 600	600	25.0	.67	G	G	4.0	.12	-10°F	+130°F	Agriculture	36
	3/8	Ag Master™ Spray 800	800	25.0	.69	G	G	4.0	.14	-10°F	+130°F	Agriculture	37
COUPLINGS AND FERRULES	3/8	Air Master™ Diving Umbilical (1000-1125)	1125	30.0	.75	C	A	4.0	.19	-20°F	+120°F	Air Breathing	43
	3/8	Air Master™ Respirator 500	500	—	.70	C	A	3.0	.18	-20°F	+120°F	Air Breathing	45
	3/8	Chem Master™ Paint Spray (500-750)	500	30.0	.67	Z	A	3.0	.14	-40°F	+150°F	Chemical	67
HOSE FINDER	3/8	Clean Master™ Pressure Wash (2500-3000)	3000	30.0	.68	C	C2	2.5	.23	-40°F	+250°F	Pressure Wash and Washdown	152
	3/8	Clean Master™ Pressure Wash (3500-4000)	4000	30.0	.68	C	C2	2.5	.23	-40°F	+250°F	Pressure Wash and Washdown	153
CHEMICAL RESISTANCE TABLE	3/8	Clean Master™ Pressure Wash (4000-6000)	5000	30.0	.74	C	C2	2.5	.35	-40°F	+250°F	Pressure Wash and Washdown	154
	3/8	Clean Master™ Pressure Wash Assemblies	3000	30.0	.63	C	C2	2.5	11.00	-40°F	+250°F	Pressure Wash and Washdown	155

## Hose Finder

Hose I.D. (in)	Name	Rated W.P. (psi)	Vacuum (In. Hg.)	Hose O.D. (in)	Tube Type	Cover Type	MBR (in)	Wt. (lbs/ft)	Temp Min. (°F)	Temp Max. (°F)	Hose Categories	Catalog Page No.
3/8	Clean Master™ Washdown 1000	1000	30.0	.73	C2	C2	4.0	.18	-40°F	+212°F	Pressure Wash and Washdown	156
3/8	Engine Coolant Silicone	110	12.0	.76	MQ	MQ	8.0	.19	-65°F	+347°F	Marine and Engine	90
3/8	Food Master® PVC (20-65) Clear	45	—	.50	G	G	—	.06	-25°F	+150°F	Food and Beverage	78
3/8	Food Master® PVC (20-65) Clear	55	—	.63	G	G	—	.12	-25°F	+150°F	Food and Beverage	78
3/8	Food Master® PVC Clear Tubing (75-250) Braid	200	—	.63	G	G	—	.11	-10°F	+130°F	Food and Beverage	79
3/8	LP350	350	30.0	.74	A	A	3.0	.21	-40°F	+180°F	Petroleum	148
3/8	LPG Vapor 125	125	25.0	.66	C	A	3.0	.14	-30°F	+150°F	Petroleum	149
3/8	MIL Low Pressure Fuel & Oil Hose	250	—	.72	A	A	3.0	.20	-40°F	+250°F	Marine and Engine	85
3/8	Plant Master® (150-200)	200	30.0	.66	P	P	3.0	.14	-40°F	+200°F	Air and Multi-Purpose	58
3/8	Plant Master® 250 Black	250	30.0	.66	P	P	3.0	.14	-40°F	+200°F	Air and Multi-Purpose	56
3/8	Plant Master® 250 Colors	250	30.0	.66	P	P	3.0	.14	-40°F	+200°F	Air and Multi-Purpose	57
3/8	Plant Master® 300	300	30.0	.67	P	P	3.0	.15	-40°F	+200°F	Air and Multi-Purpose	55
3/8	Plant Master® 300	300	30.0	.69	P	P	3.0	.15	-40°F	+200°F	Air and Multi-Purpose	55
3/8	Plant Master® 300 NC	300	30.0	.75	P	P	3.0	.19	-20°F	+150°F	Air and Multi-Purpose	59
3/8	Plant Master® Plus (200-300)	250	30.0	.66	B1	D3	3.0	.14	-40°F	+200°F	Air and Multi-Purpose	54
3/8	Plant Master® Plus (200-300)	300	30.0	.73	B1	D3	3.0	.18	-40°F	+200°F	Air and Multi-Purpose	54
3/8	Plant Master® Plus 300 Lock-On	300	30.0	.68	C	A	3.0	.15	-20°F	+212°F	Air and Multi-Purpose	53
3/8	Plant Master® Steam 250	250	30.0	.78	P2	P2	4.0	.26	-40°F	+450°F	Steam	158
3/8	Plant Master® Steam Plus 250	250	30.0	.80	P2	B1	4.0	.30	-40°F	+450°F	Steam	159
3/8	Plant Master® XTreme™ (250-315)	250	30.0	.66	C	C2	3.0	.14	-40°F	+212°F	Air and Multi-Purpose	51
3/8	Plant Master® XTreme™ (250-315)	315	30.0	.73	C	C2	3.0	.18	-40°F	+212°F	Air and Multi-Purpose	51
3/8	Plant Master® XTreme™ 300 AR	300	30.0	.70	C	C4	3.0	.16	-40°F	+212°F	Air and Multi-Purpose	52
3/8	Plant Master® XTreme™ 300 AR	300	30.0	9.50	C	C4	3.0	.16	-40°F	+212°F	Air and Multi-Purpose	52
3/8	Plant Master® XTreme™ 300 Lock-On Braid	300	27.9	.63	C	C2	3.0	.11	-40°F	+212°F	Air and Multi-Purpose	50
3/8	Plant Master® XTreme™ 325 Braid	325	30.0	.69	C	A	3.0	.15	-40°F	+212°F	Air and Multi-Purpose	48
3/8	Plant Master® XTreme™ 501 AR	501	25.0	.75	C	C4	3.0	.19	-40°F	+212°F	Air and Multi-Purpose	49
3/8	Windshield Washer and Vacuum Tubing	25	24.0	.63	P	—	3.0	3.60	-40°F	+257°F	Marine and Engine	99
13/32	C5M Marine Fuel Line Hose	500	24.0	.77	C	C2	1.8	.33	-4°F	+212°F	Marine and Engine	95
1/2	4219BF Barricade® Fuel Injection Fuel Hose 225	225	10.0	.78	J	C	5.50	.19	-40°F	+275°F	Marine and Engine	84
1/2	4219BG Barricade® Fuel Hose (35-50)	35	10.0	.78	J	C	4.72	.13	-40°F	+212°F	Marine and Engine	83
1/2	4219G Fuel Line (35-50)	35	10.0	.78	C	C2	5.0	.18	-40°F	+257°F	Marine and Engine	97
1/2	4219M Marine Master™ Fuel Line 40	40	28.0	.89	C	A	5.0	7.37	-40°F	+212°F	Marine and Engine	96
1/2	4230T Coolant Hose	75	25.0	.81	P	P	3.0	.23	-40°F	+257°F	Marine and Engine	91
1/2	Ag Master™ (200-250)	200	30.0	.81	P	P	5.0	.19	-40°F	+200°F	Agriculture	38
1/2	Ag Master™ Spray 600	600	25.0	.81	G	G	5.0	.17	-10°F	+130°F	Agriculture	36
1/2	Ag Master™ Spray 800	800	25.0	.84	G	G	5.0	.18	-10°F	+130°F	Agriculture	37
1/2	Air Master™ Diving Umbilical (1000-1125)	1000	30.0	.94	C	A	5.0	.29	-20°F	+120°F	Air Breathing	43
1/2	Bulk Master™ Sand Blast (120-150) D	150	25.0	1.23	D3	D	5.0	.55	-40°F	+150°F	Material Handling	104
1/2	C5M Marine Fuel Line Hose	500	10.0	.92	C	C2	2.3	.40	-4°F	+212°F	Marine and Engine	95
1/2	Chem Master™ Paint Spray (500-750)	750	25.0	.87	Z	A	5.0	.23	-40°F	+150°F	Chemical	67

AGRICULTURE

AIR BREATHING

AIR DUCT

AIR AND MULTI-PURPOSE

CHEMICAL

FOOD AND BEVERAGE

MARINE AND ENGINE

MATERIAL HANDLING

MINING

OILFIELD

PETROLEUM

PRESSURE WASH AND WASHDOWN

STEAM

WATER

CLAMPS

COUPLINGS AND FERRULES

HOSE FINDER

CHEMICAL RESISTANCE TABLE



## Hose Finder

	Hose I.D. (in)	Name	Rated W.P. (psi)	Vacuum (In. Hg.)	Hose O.D. (in)	Tube Type	Cover Type	MBR (in)	Wt. (lbs/ft)	Temp Min. (°F)	Temp Max. (°F)	Hose Categories	Catalog Page No.
AGRICULTURE													
AIR BREATHING													
AIR DUCT													
AIR AND MULTI-PURPOSE	1/2	Clean Master™ Pressure Wash (2500-3000)	2500	30.0	.80	C	C2	3.5	.28	-40°F	+250°F	Pressure Wash and Washdown	152
	1/2	Clean Master™ Pressure Wash (4000-6000)	4000	30.0	.86	C	C2	3.5	.42	-40°F	+250°F	Pressure Wash and Washdown	154
	1/2	Clean Master™ Pressure Wash Assemblies	3000	30.0	.76	C	C2	3.5	12.98	-40°F	+250°F	Pressure Wash and Washdown	155
CHEMICAL	1/2	Clean Master™ Washdown	200	25.0	.91	D	D	5.0	.28	-20°F	+180°F	Pressure Wash and Washdown	157
	1/2	Clean Master™ Washdown 1000	1000	30.0	.94	C2	C2	5.0	.29	-40°F	+212°F	Pressure Wash and Washdown	156
FOOD AND BEVERAGE	1/2	Engine Coolant Silicone	110	12.0	.87	MQ	MQ	8.0	.23	-65°F	+347°F	Marine and Engine	90
	1/2	Food Master® PVC (20-65) Clear	30	—	.63	G	G	—	.07	-25°F	+150°F	Food and Beverage	78
	1/2	Food Master® PVC (20-65) Clear	45	—	.75	G	G	—	.13	-25°F	+150°F	Food and Beverage	78
MARINE AND ENGINE	1/2	Food Master® PVC Clear Tubing (75-250) Braid	200	—	.75	G	G	—	.13	-10°F	+130°F	Food and Beverage	79
	1/2	LP350	350	25.0	.91	A	A	5.0	.28	-40°F	+180°F	Petroleum	148
	1/2	MIL Low Pressure Fuel & Oil Hose	250	—	.84	A	A	5.0	.24	-40°F	+250°F	Marine and Engine	85
MATERIAL HANDLING	1/2	Mine Master™ Spray 1000	1000	30.0	.84	P	C2	5.0	.29	-40°F	+212°F	Mining	106
	1/2	Plant Master® (150-200)	200	25.0	.81	P	P	5.0	.19	-40°F	+200°F	Air and Multi-Purpose	58
	1/2	Plant Master® 250 Black	250	25.0	.81	P	P	5.0	.19	-40°F	+200°F	Air and Multi-Purpose	56
MINING	1/2	Plant Master® 250 Colors	250	25.0	.81	P	P	5.0	.19	-40°F	+200°F	Air and Multi-Purpose	57
	1/2	Plant Master® 300	300	25.0	.83	P	P	5.0	.20	-40°F	+200°F	Air and Multi-Purpose	55
	1/2	Plant Master® 300 NC	300	25.0	.88	P	P	5.0	.24	-20°F	+150°F	Air and Multi-Purpose	59
OILFIELD	1/2	Plant Master® Plus (200-300)	250	25.0	.81	B1	D3	4.0	.19	-40°F	+200°F	Air and Multi-Purpose	54
	1/2	Plant Master® Plus (200-300)	300	25.0	.84	B1	D3	4.0	.22	-40°F	+200°F	Air and Multi-Purpose	54
PETROLEUM	1/2	Plant Master® Plus 300 Lock-On	300	30.0	.81	C	A	5.0	.18	-20°F	+212°F	Air and Multi-Purpose	53
	1/2	Plant Master® Steam 250	250	25.0	1.06	P2	P2	7.0	.40	-40°F	+450°F	Steam	158
	1/2	Plant Master® Steam Plus 250	250	25.0	1.02	P2	B1	7.0	.45	-40°F	+450°F	Steam	159
PRESSURE WASH AND WASHDOWN	1/2	Plant Master® XTreme™ (250-315)	250	25.0	.85	C	C2	4.0	.22	-40°F	+212°F	Air and Multi-Purpose	51
	1/2	Plant Master® XTreme™ (250-315)	315	25.0	.88	C	C2	4.0	.24	-40°F	+212°F	Air and Multi-Purpose	51
STEAM	1/2	Plant Master® XTreme™ 300 AR	300	25.0	.84	C	C4	4.0	.21	-40°F	+212°F	Air and Multi-Purpose	52
	1/2	Plant Master® XTreme™ 300 Lock-On Braid	300	27.9	.77	C	C2	5.0	.15	-40°F	+212°F	Air and Multi-Purpose	50
WATER	1/2	Plant Master® XTreme™ 325 Braid	325	25.0	.84	C	A	5.0	.20	-40°F	+212°F	Air and Multi-Purpose	48
	1/2	Plant Master® XTreme™ 501 AR	501	25.0	.89	C	C4	5.0	.25	-40°F	+212°F	Air and Multi-Purpose	49
CLAMPS	5/8	4219G Fuel Line (35-50)	35	10.0	.94	C	C2	6.0	.25	-40°F	+257°F	Marine and Engine	97
	5/8	4219M Marine Master™ Fuel Line 40	40	28.0	1.01	C	A	6.0	8.61	-40°F	+212°F	Marine and Engine	96
	5/8	4230T Coolant Hose	75	25.0	.94	P	P	4.0	.25	-40°F	+257°F	Marine and Engine	91
COUPLINGS AND FERRULES	5/8	Ag Master™ (200-250)	200	30.0	.97	P	P	6.0	.26	-40°F	+200°F	Agriculture	38
	5/8	Air Duct (5-10) SD	10	5.0	.81	A	A	1.0	.12	-30°F	+250°F	Air Duct	46
	5/8	C5M Marine Fuel Line Hose	500	10.0	1.08	C	C2	2.8	.51	-4°F	+212°F	Marine and Engine	95
	5/8	Engine Coolant Silicone	110	12.0	1.02	MQ	MQ	8.0	.27	-65°F	+347°F	Marine and Engine	90
HOSE FINDER	5/8	Food Master® PVC (20-65) Clear	25	—	.75	G	G	—	.08	-25°F	+150°F	Food and Beverage	78
	5/8	Food Master® PVC (20-65) Clear	40	—	.88	G	G	—	.16	-25°F	+150°F	Food and Beverage	78
CHEMICAL RESISTANCE TABLE	5/8	Food Master® PVC Clear Tubing (75-250) Braid	200	—	.88	G	G	—	.15	-10°F	+130°F	Food and Beverage	79
	5/8	Fuel Master™ Curb Pump 150	150	30.0	1.00	C	J	6.0	.37	-40°F	+120°F	Petroleum	150

## Hose Finder

Hose I.D. (in)	Name	Rated W.P. (psi)	Vacuum (In. Hg.)	Hose O.D. (in)	Tube Type	Cover Type	MBR (in)	Wt. (lbs/ft)	Temp Min. (°F)	Temp Max. (°F)	Hose Categories	Catalog Page No.
5/8	MIL Low Pressure Fuel & Oil Hose	250	—	.97	A	A	6.0	.28	-40°F	+250°F	Marine and Engine	85
5/8	Plant Master® (150-200)	200	20.0	.97	P	P	6.0	.26	-40°F	+200°F	Air and Multi-Purpose	58
5/8	Plant Master® 250 Colors	250	20.0	.97	P	P	6.0	.25	-40°F	+200°F	Air and Multi-Purpose	57
5/8	Plant Master® Plus (200-300)	250	20.0	.98	B1	D3	5.0	.27	-40°F	+200°F	Air and Multi-Purpose	54
5/8	Plant Master® Plus (200-300)	300	20.0	.98	B1	D3	5.0	.30	-40°F	+200°F	Air and Multi-Purpose	54
5/8	Plant Master® XTreme™ (250-315)	250	20.0	.98	C	C2	5.0	.27	-40°F	+212°F	Air and Multi-Purpose	51
5/8	Plant Master® XTreme™ (250-315)	315	20.0	.98	C	C2	5.0	.26	-40°F	+212°F	Air and Multi-Purpose	51
5/8	Plant Master® XTreme™ 300 Lock-On Braid	300	27.9	.94	C	C2	6.0	.20	-40°F	+212°F	Air and Multi-Purpose	50
5/8	Plant Master® XTreme™ 325 Braid	325	20.0	.94	C	A	6.0	.24	-40°F	+212°F	Air and Multi-Purpose	48
3/4	4169A Coolant Hose	150	8.0	1.14	C	A	10.0	.34	-40°F	+212°F	Marine and Engine	88
3/4	4175EC Coolant Hose	80	8.0	1.14	P	P	6.0	.37	-40°F	+257°F	Marine and Engine	86
3/4	4219G Fuel Line (35-50)	35	10.0	1.13	C	C2	7.0	.36	-40°F	+257°F	Marine and Engine	97
3/4	4230T Coolant Hose	75	25.0	1.06	P	P	5.0	.29	-40°F	+257°F	Marine and Engine	91
3/4	Ag Master™ (200-250)	200	30.0	1.15	P	P	6.0	.32	-40°F	+200°F	Agriculture	38
3/4	Ag Master™ Spray 600	600	25.0	1.08	G	G	6.0	.27	-10°F	+130°F	Agriculture	36
3/4	Ag Master™ Spray 800	800	25.0	1.14	G	G	6.0	.30	-10°F	+130°F	Agriculture	37
3/4	Air Duct (5-10) SD	10	5.0	.94	A	A	1.0	.14	-30°F	+250°F	Air Duct	46
3/4	Air Duct (8-20) SD	20	15.0	1.00	A	A	1.0	.20	-30°F	+250°F	Air Duct	47
3/4	Bulk Master™ Sand Blast (120-150) D	150	15.0	1.50	D3	D	8.0	.70	-40°F	+150°F	Material Handling	104
3/4	Chem Master™ DEF Transfer 350	350	15.0	1.12	P	P	4.0	.32	-40°F	+212°F	Chemical	68
3/4	Chem Master™ EPDM (125-150) SD	150	30.0	1.27	P	P	3.0	.50	-40°F	+250°F	Chemical	66
3/4	Chem Master™ Hydrocarbon Drain 250	250	30.0	1.13	C	J	6.0	.42	-40°F	+300°F	Chemical	69
3/4	Chem Master™ Paint Spray (500-750)	750	25.0	1.16	Z	A	6.0	.35	-40°F	+150°F	Chemical	67
3/4	Chem Master™ Plus CPE (150-200) SD MegaFlex®	200	30.0	1.20	J	P	1.5	.41	-40°F	+275°F	Chemical	65
3/4	Chem Master™ Plus UHMWPE (125-200) SD	200	30.0	1.22	L	P	4.0	.41	-40°F	+212°F	Chemical	64
3/4	Chem Master™ Plus XLPE (150-200) SD	200	30.0	1.25	K	P	4.0	.45	-40°F	+250°F	Chemical	62
3/4	Chem Master™ Plus XLPE 200SD CR	200	20.0	1.36	K	P	4.0	.45	-40°F	+250°F	Chemical	63
3/4	Chem Master™ XTreme™ FEP (125-200) SD	200	30.0	1.29	T	P	4.0	.52	-40°F	+300°F	Chemical	60
3/4	Chem Master™ XTreme™ FEP 200SD CR	200	20.0	1.33	T	P	4.0	.52	-40°F	+300°F	Chemical	61
3/4	Clean Master™ Washdown	150	25.0	1.25	D	D	6.0	27.50	-20°F	+180°F	Pressure Wash and Washdown	157
3/4	Clean Master™ Washdown	200	15.0	1.25	D	D	6.0	.49	-20°F	+180°F	Pressure Wash and Washdown	157
3/4	Clean Master™ Washdown 1000	1000	30.0	1.20	C2	C2	6.0	.41	-40°F	+212°F	Pressure Wash and Washdown	156
3/4	Engine Coolant Silicone	110	10.0	1.14	MQ	MQ	10.0	.31	-65°F	+347°F	Marine and Engine	90
3/4	Food Master® Oils and Dairy 150SD	150	30.0	1.29	C2	C2	2.0	.64	-40°F	+230°F	Food and Beverage	73
3/4	Food Master® PVC (20-65) Clear	35	—	1.00	G	G	—	.19	-25°F	+150°F	Food and Beverage	78
3/4	Food Master® PVC (20-65) Clear	45	—	1.25	G	G	—	.43	-25°F	+150°F	Food and Beverage	78
3/4	Food Master® PVC Clear Tubing (75-250) Braid	150	—	1.03	G	G	—	.20	-10°F	+130°F	Food and Beverage	79

AGRICULTURE

AIR BREATHING

AIR DUCT

AIR AND MULTI-PURPOSE

CHEMICAL

FOOD AND BEVERAGE

MARINE AND ENGINE

MATERIAL HANDLING

MINING

OILFIELD

PETROLEUM

PRESSURE WASH AND WASHDOWN

STEAM

WATER

CLAMPS

COUPLINGS AND FERRULES

HOSE FINDER

CHEMICAL RESISTANCE TABLE

## Hose Finder

	Hose I.D. (in)	Name	Rated W.P. (psi)	Vacuum (In. Hg.)	Hose O.D. (in)	Tube Type	Cover Type	MBR (in)	Wt. (lbs/ft)	Temp Min. (°F)	Temp Max. (°F)	Hose Categories	Catalog Page No.
AGRICULTURE													
AIR BREATHING													
AIR DUCT													
AIR AND MULTI-PURPOSE	3/4	Food Master® XTreme™ 250SD CR	250	30.0	1.22	S	P	2.0	.42	-40°F	+230°F	Food and Beverage	70
	3/4	Fuel Master™ Curb Pump 150	150	30.0	1.13	C	J	6.0	.42	-40°F	+120°F	Petroleum	150
	3/4	Fuel Master™ Diesel Curb Pump 150	150	30.0	1.13	C	J	6.0	.42	-40°F	+120°F	Petroleum	151
	3/4	LP350	350	20.0	1.23	A	A	6.0	.44	-40°F	+180°F	Petroleum	148
CHEMICAL	3/4	MIL Low Pressure Fuel & Oil Hose	250	—	1.09	A	A	6.0	.29	-40°F	+250°F	Marine and Engine	85
	3/4	Mine Master™ Air Drill 500	500	25.0	1.28	A	C2	6.0	.41	-30°F	+212°F	Mining	109
	3/4	Mine Master™ Air Drill 500 FR	500	25.0	1.11	C	C2	6.0	.41	-22°F	+180°F	Mining	110
FOOD AND BEVERAGE	3/4	Mine Master™ Spray 1000	1000	25.0	1.10	P	C2	8.0	.43	-40°F	+212°F	Mining	106
	3/4	Plant Master® (150-200)	200	15.0	1.11	P	P	6.0	.23	-40°F	+200°F	Air and Multi-Purpose	58
	3/4	Plant Master® 250 Black	250	20.0	1.15	P	P	6.0	.35	-40°F	+200°F	Air and Multi-Purpose	56
MARINE AND ENGINE	3/4	Plant Master® 250 Colors	250	20.0	1.11	P	P	6.0	.35	-40°F	+200°F	Air and Multi-Purpose	57
	3/4	Plant Master® 250 Colors	250	20.0	1.15	P	P	6.0	.35	-40°F	+200°F	Air and Multi-Purpose	57
	3/4	Plant Master® 300	300	15.0	1.15	P	P	6.0	.35	-40°F	+200°F	Air and Multi-Purpose	55
	3/4	Plant Master® 300 NC	300	20.0	1.16	P	P	6.0	.36	-20°F	+150°F	Air and Multi-Purpose	59
MATERIAL HANDLING	3/4	Plant Master® Plus (200-300)	250	20.0	1.15	B1	D3	5.0	.35	-40°F	+200°F	Air and Multi-Purpose	54
	3/4	Plant Master® Plus (200-300)	300	20.0	1.15	B1	D3	5.0	.36	-40°F	+200°F	Air and Multi-Purpose	54
MINING	3/4	Plant Master® Steam 250	250	20.0	1.27	P2	P2	9.0	.57	-40°F	+450°F	Steam	158
	3/4	Plant Master® Steam 250	250	20.0	1.28	P2	P2	9.0	.49	-40°F	+450°F	Steam	158
	3/4	Plant Master® Steam Plus 250	250	20.0	1.27	P2	B1	9.0	.60	-40°F	+450°F	Steam	159
OILFIELD	3/4	Plant Master® XTreme™ (250-315)	250	20.0	1.15	C	C2	5.0	.36	-40°F	+212°F	Air and Multi-Purpose	51
	3/4	Plant Master® XTreme™ (250-315)	315	20.0	1.19	C	C2	5.0	.39	-40°F	+212°F	Air and Multi-Purpose	51
PETROLEUM	3/4	Plant Master® XTreme™ 300 AR	300	20.0	1.19	C	C4	5.0	.40	-40°F	+212°F	Air and Multi-Purpose	52
	3/4	Plant Master® XTreme™ 300 Lock-On Braid	300	15.0	1.06	C	C2	7.0	.24	-40°F	+212°F	Air and Multi-Purpose	50
PRESSURE WASH AND WASHDOWN	3/4	Plant Master® XTreme™ 325 Braid	325	20.0	1.09	C	A	6.0	.29	-40°F	+212°F	Air and Multi-Purpose	48
	3/4	Plant Master® XTreme™ 501 AR	501	15.0	1.22	C	C4	6.0	.45	-40°F	+212°F	Air and Multi-Purpose	49
STEAM	7/8	4169A Coolant Hose	150	7.0	1.26	C	A	11.0	.38	-40°F	+212°F	Marine and Engine	88
	7/8	4175EC Coolant Hose	75	7.0	1.26	P	P	7.0	.39	-40°F	+257°F	Marine and Engine	86
	7/8	4176HD Coolant Hose	175	15.0	1.38	P	P	7.0	.58	-40°F	+257°F	Marine and Engine	87
	7/8	Air Duct (5-10) SD	10	5.0	1.06	A	A	1.0	.17	-30°F	+250°F	Air Duct	46
WATER	7/8	C5M Marine Fuel Line Hose	500	10.0	1.23	C	C2	3.5	.62	-4°F	+212°F	Marine and Engine	95
	7/8	Engine Coolant Silicone	110	7.0	1.26	MQ	MQ	11.0	.35	-65°F	+347°F	Marine and Engine	90
	7/8	Fuel Master™ Diesel Curb Pump 150	150	30.0	1.22	C	J	7.0	.42	-40°F	+120°F	Petroleum	151
CLAMPS	7/8	MIL Low Pressure Fuel & Oil Hose	250	—	1.22	A	A	7.0	.34	-40°F	+250°F	Marine and Engine	85
	1	4169A Coolant Hose	135	7.0	1.39	C	A	12.0	.43	-40°F	+212°F	Marine and Engine	88
	1	4175EC Coolant Hose	138	7.0	1.39	P	P	8.0	.42	-40°F	+257°F	Marine and Engine	86
COUPLINGS AND FERRULES	1	4176HD Coolant Hose	175	10.0	1.51	P	P	8.0	.62	-40°F	+257°F	Marine and Engine	87
	1	4230T Coolant Hose	75	25.0	1.34	P	P	7.0	.40	-40°F	+257°F	Marine and Engine	91
	1	Ag Master™ (200-250)	200	30.0	1.40	P	P	8.0	.44	-40°F	+200°F	Agriculture	38
HOSE FINDER	1	Ag Master™ PVC Solution (30-90) SD Clear	35	28.0	1.26	G	—	2.0	.14	-10°F	+130°F	Agriculture	42
	1	Ag Master™ PVC Solution (30-90) SD Clear	90	28.0	1.27	G	—	3.0	.27	-10°F	+130°F	Agriculture	42
CHEMICAL RESISTANCE TABLE	1	Ag Master™ PVC Solution (35-80) SD	80	28.0	1.34	P	G	4.0	.23	-30°F	+140°F	Agriculture	41
	1	Air Duct (5-10) SD	10	5.0	1.19	A	A	1.0	.20	-30°F	+250°F	Air Duct	46

## Hose Finder

Hose I.D. (in)	Name	Rated W.P. (psi)	Vacuum (In. Hg.)	Hose O.D. (in)	Tube Type	Cover Type	MBR (in)	Wt. (lbs/ft)	Temp Min. (°F)	Temp Max. (°F)	Hose Categories	Catalog Page No.
1	Air Duct (8-20) SD	20	15.0	1.25	A	A	1.0	.26	-30°F	+250°F	Air Duct	47
1	Black Gold® ABS Chemical Plus XLPE 250SD	250	30.0	1.50	K	P	5.0	.56	-40°F	+250°F	Oilfield	112
1	Black Gold® Potable Water (150-300) D	300	15.0	1.53	D2	P	10.0	.56	-40°F	+150°F	Oilfield	118
1	Black Gold® Slim Hole Rotary (1500-5000)	5000	—	1.53	C	A	12.0	1.49	-40°F	+180°F	Oilfield	115
1	Black Gold® Super-Vac® (60-150) SD	150	30.0	1.42	C	D	3.0	.52	-40°F	+180°F	Oilfield	122
1	Bulk Master™ (4-24) SD	4	20.0	1.39	D3	D	5.0	.49	-40°F	+150°F	Material Handling	103
1	Bulk Master™ Sand Blast (120-150) D	150	5.0	1.63	D3	D	12.0	.70	-40°F	+150°F	Material Handling	104
1	Bulk Master™ Sand Blast (120-150) D	150	5.0	1.87	D3	D	12.0	.96	-40°F	+150°F	Material Handling	104
1	Chem Master™ DEF Transfer 350	350	10.0	1.36	P	P	6.0	1.00	-40°F	+212°F	Chemical	68
1	Chem Master™ EPDM (125-150) SD	150	30.0	1.52	P	P	3.5	.61	-40°F	+250°F	Chemical	66
1	Chem Master™ Plus CPE (150-200) SD MegaFlex®	200	30.0	1.46	J	P	2.0	.51	-40°F	+275°F	Chemical	65
1	Chem Master™ Plus UHMWPE (125-200) SD	200	30.0	1.47	L	P	5.0	.51	-40°F	+212°F	Chemical	64
1	Chem Master™ Plus XLPE (150-200) SD	200	30.0	1.50	K	P	5.0	.56	-40°F	+250°F	Chemical	62
1	Chem Master™ Plus XLPE 200SD CR	200	20.0	1.61	K	P	5.0	.56	-40°F	+250°F	Chemical	63
1	Chem Master™ XTreme™ FEP (125-200) SD	200	30.0	1.56	T	P	5.0	.63	-40°F	+300°F	Chemical	60
1	Chem Master™ XTreme™ FEP 200SD CR	200	20.0	1.58	T	P	5.0	.63	-40°F	+300°F	Chemical	61
1	Clean Master™ Washdown	150	15.0	1.50	D	D	8.0	33.50	-20°F	+180°F	Pressure Wash and Washdown	157
1	Clean Master™ Washdown	200	15.0	1.52	D	D	8.0	.65	-20°F	+180°F	Pressure Wash and Washdown	157
1	Engine Coolant Silicone	90	7.0	1.39	MQ	MQ	12.0	.40	-65°F	+347°F	Marine and Engine	90
1	Food Master® Beverage 250SD CR	250	30.0	1.48	S	P	3.0	.52	-40°F	+230°F	Food and Beverage	71
1	Food Master® Oils and Dairy 150SD	150	30.0	1.54	C2	C2	3.0	.79	-40°F	+230°F	Food and Beverage	73
1	Food Master® Oils and Dairy 150SD MegaFlex®	150	30.0	1.47	C2	C2	2.0	.58	-40°F	+230°F	Food and Beverage	75
1	Food Master® PVC (20-65) Clear	25	—	1.25	G	G	—	.21	-25°F	+150°F	Food and Beverage	78
1	Food Master® PVC (20-65) Clear	35	—	1.50	G	G	—	.54	-25°F	+150°F	Food and Beverage	78
1	Food Master® PVC (35-50) SD Clear	40	28.0	1.26	G	G	2.0	.14	-10°F	+130°F	Food and Beverage	81
1	Food Master® PVC (50-100) SD Clear	100	28.0	1.29	G	G	3.0	.30	-10°F	+130°F	Food and Beverage	80
1	Food Master® PVC Clear Tubing (75-250) Braid	125	—	1.31	G	G	—	.32	-10°F	+130°F	Food and Beverage	79
1	Food Master® XTreme™ 250SD CR	250	30.0	1.48	S	P	3.0	.52	-40°F	+230°F	Food and Beverage	70
1	Fuel Master™ 150SD	150	30.0	1.50	C	A	3.0	.54	-40°F	+180°F	Petroleum	137
1	Fuel Master™ 150SD MegaFlex®	150	30.0	1.41	C	A	1.0	.46	-40°F	+180°F	Petroleum	138
1	Fuel Master™ Curb Pump 150	150	30.0	1.38	C	J	8.0	.57	-40°F	+120°F	Petroleum	150
1	Fuel Master™ Delivery 200	200	10.0	1.50	C	C4	8.0	.58	-40°F	+180°F	Petroleum	146
1	Fuel Master™ Diesel Curb Pump 150	150	30.0	1.38	C	J	8.0	.53	-40°F	+120°F	Petroleum	151
1	Fuel Master™ XTreme™ 150SD	150	30.0	1.50	C	C2	3.0	.59	-30°F	+180°F	Petroleum	135

AGRICULTURE

AIR BREATHING

AIR DUCT

AIR AND MULTI-PURPOSE

CHEMICAL

FOOD AND BEVERAGE

MARINE AND ENGINE

MATERIAL HANDLING

MINING

OILFIELD

PETROLEUM

PRESSURE WASH AND WASHDOWN

STEAM

WATER

CLAMPS

COUPLINGS AND FERRULES

HOSE FINDER

CHEMICAL RESISTANCE TABLE

## Hose Finder

	Hose I.D. (in)	Name	Rated W.P. (psi)	Vacuum (In. Hg.)	Hose O.D. (in)	Tube Type	Cover Type	MBR (in)	Wt. (lbs/ft)	Temp Min. (°F)	Temp Max. (°F)	Hose Categories	Catalog Page No.
AGRICULTURE													
AIR BREATHING													
AIR DUCT													
AIR AND MULTI-PURPOSE	1	Green Stripe® Coolant and Air Hose	100	25.0	1.46	P	P	2.0	2.50	-40°F	+257°F	Marine and Engine	89
	1	LP350	350	15.0	1.51	A	A	15.0	.63	-40°F	+180°F	Petroleum	148
	1	LP350	350	15.0	1.51	A	A	8.0	.60	-40°F	+180°F	Petroleum	148
	1	Marine Master™ Plus Wet Exhaust (15-100) SD	100	25.0	1.46	C	A	3.0	.51	-40°F	+212°F	Marine and Engine	94
CHEMICAL	1	MIL Low Pressure Fuel & Oil Hose	250	—	1.34	A	A	8.0	.38	-40°F	+250°F	Marine and Engine	85
	1	Mine Master™ Air Drill 500	500	25.0	1.55	A	C2	8.0	.80	-30°F	+212°F	Mining	109
	1	Mine Master™ Air Drill 500 FR	500	25.0	1.45	C	C2	8.0	.65	-22°F	+180°F	Mining	110
FOOD AND BEVERAGE	1	Mine Master™ Spray 1000	1000	25.0	1.42	P	C2	11.0	.66	-40°F	+212°F	Mining	106
	1	Plant Master® (150-200)	150	10.0	1.39	P	P	8.0	.48	-40°F	+200°F	Air and Multi-Purpose	58
	1	Plant Master® (150-200)	150	10.0	1.40	P	P	8.0	.48	-40°F	+200°F	Air and Multi-Purpose	58
	1	Plant Master® (150-200)	200	10.0	1.39	P	P	8.0	.48	-40°F	+200°F	Air and Multi-Purpose	58
MARINE AND ENGINE	1	Plant Master® (150-200)	200	10.0	1.40	P	P	8.0	.45	-40°F	+200°F	Air and Multi-Purpose	58
	1	Plant Master® 250 Colors	250	10.0	1.47	P	P	8.0	.62	-40°F	+200°F	Air and Multi-Purpose	57
	1	Plant Master® 300	300	10.0	1.47	P	P	8.0	.54	-40°F	+200°F	Air and Multi-Purpose	55
	1	Plant Master® 300	300	10.0	1.48	P	P	8.0	.59	-40°F	+200°F	Air and Multi-Purpose	55
MATERIAL HANDLING	1	Plant Master® Plus (200-300)	250	10.0	1.47	B1	D3	8.0	.54	-40°F	+200°F	Air and Multi-Purpose	54
	1	Plant Master® Steam 250	250	20.0	1.52	P2	P2	11.0	.70	-40°F	+450°F	Steam	158
	1	Plant Master® Steam 250	250	20.0	1.63	P2	P2	11.0	.78	-40°F	+450°F	Steam	158
MINING	1	Plant Master® Steam Plus 250	250	20.0	1.52	P2	B1	11.0	.73	-40°F	+450°F	Steam	159
	1	Plant Master® XTreme™ (250-315)	250	10.0	1.47	C	C2	8.0	.54	-40°F	+212°F	Air and Multi-Purpose	51
OILFIELD	1	Plant Master® XTreme™ 300 AR	300	10.0	1.50	C	C4	8.0	.59	-40°F	+212°F	Air and Multi-Purpose	52
	1	Plant Master® XTreme™ 325 Braid	325	10.0	1.38	C	A	8.0	.41	-40°F	+212°F	Air and Multi-Purpose	48
PETROLEUM	1	Plant Master® XTreme™ 501 AR	501	10.0	1.51	C	C4	8.0	.57	-40°F	+212°F	Air and Multi-Purpose	49
	1	Water Master® (100-150) SD	150	30.0	1.33	P	P	5.0	.39	-32°F	+200°F	Water	161
PRESSURE WASH AND WASHDOWN	1	Water Master® (100-150) SD AR	150	30.0	1.45	P	D	5.0	.53	-40°F	+180°F	Water	160
	1 1/8	4169A Coolant Hose	135	6.0	1.55	C	A	13.0	.48	-40°F	+212°F	Marine and Engine	88
	1 1/8	4175EC Coolant Hose	125	6.0	1.52	P	P	8.0	.47	-40°F	+257°F	Marine and Engine	86
	1 1/8	4176HD Coolant Hose	175	10.0	1.63	P	P	8.0	.68	-40°F	+257°F	Marine and Engine	87
STEAM	1 1/8	Engine Coolant Silicone	90	6.0	1.52	MQ	MQ	13.0	.44	-65°F	+347°F	Marine and Engine	90
	1 1/8	Green Stripe® Coolant and Air Hose	100	25.0	1.58	P	P	2.5	5.30	-40°F	+257°F	Marine and Engine	89
WATER	1 1/8	Marine Master™ Plus Wet Exhaust (15-100) SD	100	25.0	1.56	C	A	4.0	.56	-40°F	+212°F	Marine and Engine	94
	1 1/8	Marine Master™ Wet Exhaust 100D	100	—	1.40	P	P	—	5.59	-40°F	+257°F	Marine and Engine	92
CLAMPS	1 1/8	Marine Master™ Wet Exhaust 100SD	100	25.0	1.50	P	P	2.5	7.31	-40°F	+257°F	Marine and Engine	93
	1 1/4	4169A Coolant Hose	135	5.0	1.64	C	A	14.0	.51	-40°F	+212°F	Marine and Engine	88
	1 1/4	4175EC Coolant Hose	100	5.0	1.64	P	P	12.0	.51	-40°F	+257°F	Marine and Engine	86
COUPLINGS AND FERRULES	1 1/4	4176HD Coolant Hose	125	10.0	1.76	P	P	12.0	.70	-40°F	+257°F	Marine and Engine	87
	1 1/4	Ag Master™ (200-250)	250	30.0	1.73	P	P	10.0	.68	-40°F	+200°F	Agriculture	38
	1 1/4	Ag Master™ PVC Solution (30-90) SD Clear	50	28.0	1.61	G	—	3.0	.31	-10°F	+130°F	Agriculture	42
HOSE FINDER	1 1/4	Ag Master™ PVC Solution (30-90) SD Clear	90	28.0	1.53	G	—	4.0	.34	-10°F	+130°F	Agriculture	42
	1 1/4	Ag Master™ PVC Solution (35-80) SD	70	28.0	1.61	P	G	5.0	.30	-30°F	+140°F	Agriculture	41
CHEMICAL RESISTANCE TABLE	1 1/4	Ag Master™ PVC XTreme™ (90-100) SD	100	30.0	1.75	P	P	3.0	.45	-40°F	+140°F	Agriculture	40
	1 1/4	Ag Master™ Solution 150SD	150	30.0	1.61	P	P	5.0	.53	-40°F	+180°F	Agriculture	39

## Hose Finder

Hose I.D. (in)	Name	Rated W.P. (psi)	Vacuum (In. Hg.)	Hose O.D. (in)	Tube Type	Cover Type	MBR (in)	Wt. (lbs/ft)	Temp Min. (°F)	Temp Max. (°F)	Hose Categories	Catalog Page No.
1 1/4	Air Duct (5-10) SD	10	5.0	1.44	A	A	1.0	.22	-30°F	+250°F	Air Duct	46
1 1/4	Air Duct (8-20) SD	20	15.0	1.50	A	A	1.0	.34	-30°F	+250°F	Air Duct	47
1 1/4	Black Gold® Slim Hole Rotary (1500-5000)	5000	—	1.97	C	A	16.5	2.67	-40°F	+180°F	Oilfield	115
1 1/4	Black Gold® Super-Vac® (60-150) SD	150	30.0	1.68	C	D	3.0	.67	-40°F	+180°F	Oilfield	122
1 1/4	Bulk Master™ (4-24) SD	5	20.0	1.64	D3	D	5.0	.59	-40°F	+150°F	Material Handling	103
1 1/4	Bulk Master™ Sand Blast (120-150) D	150	5.0	2.16	D3	D	12.0	1.12	-40°F	+150°F	Material Handling	104
1 1/4	Chem Master™ EPDM (125-150) SD	150	30.0	1.79	P	P	4.0	.77	-40°F	+250°F	Chemical	66
1 1/4	Chem Master™ Plus CPE (150-200) SD MegaFlex®	200	30.0	1.72	J	P	2.5	.65	-40°F	+275°F	Chemical	65
1 1/4	Chem Master™ Plus UHMWPE (125-200) SD	200	30.0	1.72	L	P	6.0	.60	-40°F	+212°F	Chemical	64
1 1/4	Chem Master™ Plus XLPE (150-200) SD	200	30.0	1.75	K	P	6.0	.70	-40°F	+250°F	Chemical	62
1 1/4	Chem Master™ XTreme™ FEP (125-200) SD	200	30.0	1.80	T	P	7.0	.74	-40°F	+300°F	Chemical	60
1 1/4	Clean Master™ Washdown	150	15.0	1.75	D	D	10.0	39.50	-20°F	+180°F	Pressure Wash and Washdown	157
1 1/4	Engine Coolant Silicone	85	5.0	1.64	MQ	MQ	14.0	.48	-65°F	+347°F	Marine and Engine	90
1 1/4	Food Master® PVC (20-65) Clear	20	—	1.50	G	G	—	.28	-25°F	+150°F	Food and Beverage	78
1 1/4	Food Master® PVC (20-65) Clear	40	—	1.75	G	G	—	.67	-25°F	+150°F	Food and Beverage	78
1 1/4	Food Master® PVC (35-50) SD Clear	50	28.0	1.61	G	G	3.0	.28	-10°F	+130°F	Food and Beverage	81
1 1/4	Food Master® PVC (50-100) SD Clear	90	28.0	1.56	G	G	4.0	.38	-10°F	+130°F	Food and Beverage	80
1 1/4	Food Master® PVC Clear Tubing (75-250) Braid	100	—	1.75	G	G	—	.63	-10°F	+130°F	Food and Beverage	79
1 1/4	Fuel Master™ 150SD	150	30.0	1.75	C	A	4.0	.71	-40°F	+180°F	Petroleum	137
1 1/4	Fuel Master™ Delivery 200	200	10.0	1.75	C	C4	10.0	.75	-40°F	+180°F	Petroleum	146
1 1/4	Fuel Master™ XTreme™ 150SD	150	30.0	1.75	C	C2	4.0	.70	-30°F	+180°F	Petroleum	135
1 1/4	Green Stripe® Coolant and Air Hose	100	25.0	1.71	P	P	2.5	3.13	-40°F	+257°F	Marine and Engine	89
1 1/4	LP350	350	10.0	1.85	A	A	10.0	.98	-40°F	+180°F	Petroleum	148
1 1/4	Marine Master™ Plus Wet Exhaust (15-100) SD	100	25.0	1.69	C	A	4.0	.61	-40°F	+212°F	Marine and Engine	94
1 1/4	Marine Master™ Wet Exhaust 100D	100	—	1.53	P	P	—	6.07	-40°F	+257°F	Marine and Engine	92
1 1/4	Marine Master™ Wet Exhaust 100SD	100	25.0	1.63	P	P	2.5	7.92	-40°F	+257°F	Marine and Engine	93
1 1/4	MIL Low Pressure Fuel & Oil Hose	200	—	1.52	A	A	10.0	.62	-40°F	+250°F	Marine and Engine	85
1 1/4	Mine Master™ Air Drill 500	500	15.0	1.80	A	C2	10.0	1.02	-30°F	+212°F	Mining	109
1 1/4	Mine Master™ Air Drill 500 FR	500	15.0	1.74	C	C2	10.0	.85	-22°F	+180°F	Mining	110
1 1/4	Mine Master™ Rock Dust 100SD	100	30.0	1.67	D	C2	6.0	.56	-40°F	+180°F	Mining	111
1 1/4	Mine Master™ Spray 1000	1000	20.0	1.69	P	C2	16.0	.81	-40°F	+212°F	Mining	106
1 1/4	Plant Master® 250 Black	250	10.0	1.73	P	P	10.0	.68	-40°F	+200°F	Air and Multi-Purpose	56
1 1/4	Plant Master® Plus (200-300)	250	10.0	1.73	B1	D3	10.0	.67	-40°F	+200°F	Air and Multi-Purpose	54
1 1/4	Plant Master® Steam 250	250	20.0	1.81	P2	P2	16.0	.90	-40°F	+450°F	Steam	158
1 1/4	Plant Master® XTreme™ (250-315)	250	10.0	1.75	C	C2	10.0	.67	-40°F	+212°F	Air and Multi-Purpose	51
1 1/4	Plant Master® XTreme™ 501 AR	501	10.0	1.78	C	C4	10.0	.73	-40°F	+212°F	Air and Multi-Purpose	49
1 1/4	Water Master® (100-150) SD	150	30.0	1.61	P	P	5.0	.51	-32°F	+200°F	Water	161

AGRICULTURE

AIR BREATHING

AIR DUCT

AIR AND MULTI-PURPOSE

CHEMICAL

FOOD AND BEVERAGE

MARINE AND ENGINE

MATERIAL HANDLING

MINING

OILFIELD

PETROLEUM

PRESSURE WASH AND WASHDOWN

STEAM

WATER

CLAMPS

COUPLINGS AND FERRULES

HOSE FINDER

CHEMICAL RESISTANCE TABLE

## Hose Finder

	Hose I.D. (in)	Name	Rated W.P. (psi)	Vacuum (In. Hg.)	Hose O.D. (in)	Tube Type	Cover Type	MBR (in)	Wt. (lbs/ft)	Temp Min. (°F)	Temp Max. (°F)	Hose Categories	Catalog Page No.
AGRICULTURE													
AIR BREATHING													
AIR DUCT													
AIR AND MULTI-PURPOSE	1 1/4	Water Master® (100-150) SD AR	150	30.0	1.71	P	D	6.0	.68	-40°F	+180°F	Water	160
	1 1/4	Water Master® (90-150) D	150	—	1.53	P	P	—	.37	-40°F	+180°F	Water	165
	1 3/8	4169A Coolant Hose	100	4.0	1.76	C	A	25.0	.56	-40°F	+212°F	Marine and Engine	88
	1 3/8	4175EC Coolant Hose	100	4.0	1.76	P	P	12.0	.56	-40°F	+257°F	Marine and Engine	86
	1 3/8	4176HD Coolant Hose	110	10.0	1.88	P	P	12.0	.76	-40°F	+257°F	Marine and Engine	87
CHEMICAL	1 3/8	4663K Fuel Fill Hose - Corrugated	20	30.0	1.63	C	A	5.0	.38	-40°F	+212°F	Marine and Engine	98
	1 3/8	Air Duct (5-10) SD	10	5.0	1.56	A	A	1.5	.24	-30°F	+250°F	Air Duct	46
	1 3/8	Air Duct (8-20) SD	15	15.0	1.62	A	A	1.5	.44	-30°F	+250°F	Air Duct	47
FOOD AND BEVERAGE	1 3/8	Engine Coolant Silicone	85	4.0	1.76	MQ	MQ	26.0	.52	-65°F	+347°F	Marine and Engine	90
	1 3/8	Fuel Master™ Delivery 200	200	10.0	1.87	C	C4	10.0	.86	-40°F	+180°F	Petroleum	146
	1 3/8	Green Stripe® Coolant and Air Hose	85	25.0	1.83	P	P	3.0	3.25	-40°F	+257°F	Marine and Engine	89
MARINE AND ENGINE	1 3/8	Marine Master™ Plus Wet Exhaust (15-100) SD	85	25.0	1.82	C	A	4.0	.66	-40°F	+212°F	Marine and Engine	94
	1 3/8	Marine Master™ Wet Exhaust 100D	100	—	1.69	P	P	—	6.58	-40°F	+257°F	Marine and Engine	92
	1 3/8	Marine Master™ Wet Exhaust 100SD	100	25.0	1.75	P	P	3.0	8.55	-40°F	+257°F	Marine and Engine	93
MATERIAL HANDLING	1 3/8	Plant Master® Plus (200-300)	250	10.0	1.88	B1	D3	11.0	.86	-40°F	+200°F	Air and Multi-Purpose	54
	1 1/2	4169A Coolant Hose	100	3.0	1.89	C	A	30.0	.60	-40°F	+212°F	Marine and Engine	88
MINING	1 1/2	4175EC Coolant Hose	100	3.0	1.89	P	P	12.0	.60	-40°F	+257°F	Marine and Engine	86
	1 1/2	4176HD Coolant Hose	112	10.0	2.01	P	P	12.0	.81	-40°F	+257°F	Marine and Engine	87
	1 1/2	4663K Fuel Fill Hose - Corrugated	20	30.0	1.77	C	A	5.0	.41	-40°F	+212°F	Marine and Engine	98
OILFIELD	1 1/2	Ag Master™ (200-250)	250	30.0	1.98	P	P	12.0	.79	-40°F	+200°F	Agriculture	38
	1 1/2	Ag Master™ PVC Solution (30-90) SD Clear	50	28.0	1.86	G	—	3.0	.37	-10°F	+130°F	Agriculture	42
PETROLEUM	1 1/2	Ag Master™ PVC Solution (30-90) SD Clear	90	28.0	1.82	G	—	5.0	.47	-10°F	+130°F	Agriculture	42
	1 1/2	Ag Master™ PVC Solution (35-80) SD	60	28.0	1.96	P	G	6.0	.49	-30°F	+140°F	Agriculture	41
PRESSURE WASH AND WASHDOWN	1 1/2	Ag Master™ PVC XTreme™ (90-100) SD	100	30.0	1.97	P	P	3.0	.50	-40°F	+140°F	Agriculture	40
	1 1/2	Ag Master™ Solution 150SD	150	30.0	1.86	P	P	6.0	.60	-40°F	+180°F	Agriculture	39
	1 1/2	Air Duct (5-10) SD	10	5.0	1.69	A	A	1.5	.26	-30°F	+250°F	Air Duct	46
	1 1/2	Air Duct (8-20) SD	15	15.0	1.75	A	A	1.5	.48	-30°F	+250°F	Air Duct	47
STEAM	1 1/2	Black Gold® Slim Hole Rotary (1500-5000)	5000	—	2.26	C	A	20.0	3.33	-40°F	+180°F	Oilfield	115
	1 1/2	Black Gold® Super-Vac® (60-150) SD	150	30.0	1.97	C	D	3.0	.77	-40°F	+180°F	Oilfield	122
WATER	1 1/2	Bulk Master™ (4-24) SD	6	20.0	1.89	D3	D	6.0	.68	-40°F	+150°F	Material Handling	103
	1 1/2	Bulk Master™ Hot Air Blower (40-130) SD HT	130	30.0	2.08	P	P	8.0	.89	-40°F	+350°F	Material Handling	102
CLAMPS	1 1/2	Bulk Master™ PVC (25-40) SD AR	40	28.0	1.88	C	G	3.0	.38	-30°F	+140°F	Material Handling	105
	1 1/2	Bulk Master™ Sand Blast (120-150) D	135	5.0	2.37	D3	D	18.0	1.56	-40°F	+150°F	Material Handling	104
COUPLINGS AND FERRULES	1 1/2	Chem Master™ EPDM (125-150) SD	150	30.0	2.04	P	P	5.0	.89	-40°F	+250°F	Chemical	66
	1 1/2	Chem Master™ Plus CPE (150-200) SD MegaFlex®	200	30.0	1.92	J	P	3.0	.75	-40°F	+275°F	Chemical	65
HOSE FINDER	1 1/2	Chem Master™ Plus UHMWPE (125-200) SD	200	30.0	2.00	L	P	8.0	.78	-40°F	+212°F	Chemical	64
	1 1/2	Chem Master™ Plus XLPE (150-200) SD	200	30.0	2.04	K	P	8.0	.70	-40°F	+250°F	Chemical	62
CHEMICAL RESISTANCE TABLE	1 1/2	Chem Master™ Plus XLPE 200SD CR	200	20.0	2.13	K	P	8.0	.87	-40°F	+250°F	Chemical	63
	1 1/2	Chem Master™ XTreme™ FEP (125-200) SD	200	30.0	2.05	T	P	8.0	.93	-40°F	+300°F	Chemical	60

## Hose Finder

Hose I.D. (in)	Name	Rated W.P. (psi)	Vacuum (In. Hg.)	Hose O.D. (in)	Tube Type	Cover Type	MBR (in)	Wt. (lbs/ft)	Temp Min. (°F)	Temp Max. (°F)	Hose Categories	Catalog Page No.
1 1/2	Chem Master™ XTreme™ FEP 200SD CR	200	20.0	2.08	T	P	8.0	.93	-40°F	+300°F	Chemical	61
1 1/2	Engine Coolant Silicone	85	3.0	1.89	MQ	MQ	30.0	.57	-65°F	+347°F	Marine and Engine	90
1 1/2	Food Master® Beverage 150SD CR	150	30.0	2.00	S	P	6.0	.65	-40°F	+212°F	Food and Beverage	72
1 1/2	Food Master® Beverage 250SD CR	250	30.0	2.07	S	P	4.5	.97	-40°F	+230°F	Food and Beverage	71
1 1/2	Food Master® Dry Goods (50-150) SD	150	30.0	2.23	D2	P	10.0	1.24	-40°F	+150°F	Food and Beverage	76
1 1/2	Food Master® Oils and Dairy 150D	150	—	2.04	C2	C2	18.0	.97	-40°F	+230°F	Food and Beverage	74
1 1/2	Food Master® Oils and Dairy 150SD	150	30.0	2.05	C2	C2	4.5	1.15	-40°F	+230°F	Food and Beverage	73
1 1/2	Food Master® Oils and Dairy 150SD MegaFlex®	150	30.0	1.99	C2	C2	3.0	.87	-40°F	+230°F	Food and Beverage	75
1 1/2	Food Master® PVC (20-65) Clear	35	—	2.00	G	G	—	.85	-25°F	+150°F	Food and Beverage	78
1 1/2	Food Master® PVC (35-50) SD Clear	50	28.0	1.82	G	G	3.0	.37	-10°F	+130°F	Food and Beverage	81
1 1/2	Food Master® PVC (50-100) SD Clear	90	28.0	1.84	G	G	5.0	.48	-10°F	+130°F	Food and Beverage	80
1 1/2	Food Master® PVC Clear Tubing (75-250) Braid	75	—	2.00	G	G	—	.74	-10°F	+130°F	Food and Beverage	79
1 1/2	Food Master® XTreme™ 250SD CR	250	30.0	2.07	S	P	4.5	.90	-40°F	+230°F	Food and Beverage	70
1 1/2	Fuel Master™ 150SD	150	30.0	2.02	C	A	4.0	1.05	-40°F	+180°F	Petroleum	137
1 1/2	Fuel Master™ 150SD MegaFlex®	150	30.0	1.90	C	A	1.5	.72	-40°F	+180°F	Petroleum	138
1 1/2	Fuel Master™ Delivery 200	200	10.0	2.08	C	C4	12.0	.95	-40°F	+180°F	Petroleum	146
1 1/2	Fuel Master™ PVC Vapor Recovery 5SD	5	—	1.88	U	G	1.5	.36	-30°F	+140°F	Petroleum	144
1 1/2	Fuel Master™ XTreme™ 150SD	150	30.0	2.02	C	C2	4.0	.87	-30°F	+180°F	Petroleum	135
1 1/2	Green Stripe® Coolant and Air Hose	85	20.0	1.96	P	P	3.5	3.62	-40°F	+257°F	Marine and Engine	89
1 1/2	LP350	350	10.0	2.25	A	A	12.0	1.26	-40°F	+180°F	Petroleum	148
1 1/2	Marine Master™ Plus Wet Exhaust (15-100) SD	85	20.0	1.94	C	A	4.0	.70	-40°F	+212°F	Marine and Engine	94
1 1/2	Marine Master™ Wet Exhaust 100D	100	—	1.78	P	P	—	7.12	-40°F	+257°F	Marine and Engine	92
1 1/2	Marine Master™ Wet Exhaust 100SD	100	20.0	1.88	P	P	3.5	9.19	-40°F	+257°F	Marine and Engine	93
1 1/2	MIL Low Pressure Fuel & Oil Hose	200	—	1.77	A	A	12.0	.71	-40°F	+250°F	Marine and Engine	85
1 1/2	Mine Master™ Air Drill 500	500	15.0	2.21	A	C2	12.0	1.42	-30°F	+212°F	Mining	109
1 1/2	Mine Master™ Air Drill 500 FR	500	15.0	1.99	C	C2	12.0	1.00	-22°F	+180°F	Mining	110
1 1/2	Mine Master™ Air Drill 600HT	600	—	2.02	J	J	12.0	1.13	-40°F	+300°F	Mining	108
1 1/2	Mine Master™ Rock Dust 100SD	100	30.0	1.92	D	C2	8.0	.66	-40°F	+180°F	Mining	111
1 1/2	Mine Master™ Spray 1000	1000	15.0	1.92	P	C2	18.0	1.07	-40°F	+212°F	Mining	106
1 1/2	Plant Master® 250 Black	250	10.0	1.98	P	P	12.0	.85	-40°F	+200°F	Air and Multi-Purpose	56
1 1/2	Plant Master® Plus (200-300)	250	10.0	1.98	B1	D3	12.0	.79	-40°F	+200°F	Air and Multi-Purpose	54
1 1/2	Plant Master® Steam 250	250	10.0	2.14	P2	P2	20.0	1.21	-40°F	+450°F	Steam	158
1 1/2	Plant Master® Steam Plus 250	250	10.0	2.18	P2	B1	20.0	1.24	-40°F	+450°F	Steam	159
1 1/2	Plant Master® XTreme™ (250-315)	250	10.0	2.00	C	C2	12.0	.85	-40°F	+212°F	Air and Multi-Purpose	51
1 1/2	Plant Master® XTreme™ 501 AR	501	10.0	2.09	C	C4	12.0	.96	-40°F	+212°F	Air and Multi-Purpose	49
1 1/2	Water Master® (100-150) SD	150	30.0	1.86	P	P	6.0	.60	-32°F	+200°F	Water	161

AGRICULTURE

AIR BREATHING

AIR DUCT

AIR AND MULTI-PURPOSE

CHEMICAL

FOOD AND BEVERAGE

MARINE AND ENGINE

MATERIAL HANDLING

MINING

OILFIELD

PETROLEUM

PRESSURE WASH AND WASHDOWN

STEAM

WATER

CLAMPS

COUPLINGS AND FERRULES

HOSE FINDER

CHEMICAL RESISTANCE TABLE



## Hose Finder

	Hose I.D. (in)	Name	Rated W.P. (psi)	Vacuum (In. Hg.)	Hose O.D. (in)	Tube Type	Cover Type	MBR (in)	Wt. (lbs/ft)	Temp Min. (°F)	Temp Max. (°F)	Hose Categories	Catalog Page No.
AGRICULTURE													
AIR BREATHING													
AIR DUCT													
AIR AND MULTI-PURPOSE	1 1/2	Water Master® (100-150) SD AR	150	30.0	1.96	P	D	8.0	.79	-40°F	+180°F	Water	160
	1 1/2	Water Master® (90-150) D	150	—	1.78	P	P	—	.43	-40°F	+180°F	Water	165
	1 1/2	Water Master® 150D AR	150	—	1.82	P	D	12.0	.47	-40°F	+180°F	Water	164
	1 1/2	Water Master® 150D AR	150	—	1.90	P	D	12.0	.63	-40°F	+180°F	Water	164
CHEMICAL	1 1/2	Water Master® Plus PVC Layflat (100-150) D	150	—	1.71	G	G	—	.23	-10°F	+150°F	Water	168
	1 1/2	Water Master® PVC (40-100) SD	110	28.0	2.03	G1	G1	2.5	.47	-13°F	+140°F	Water	166
FOOD AND BEVERAGE	1 1/2	Water Master® PVC Layflat (45-75) D	75	—	1.67	G	G	—	.17	+25°F	+120°F	Water	167
	1 1/2	Water Master® Slurry 150D AR	150	—	1.98	D	D	12.0	.70	-40°F	+150°F	Water	163
	1 5/8	4169A Coolant Hose	85	2.0	2.02	C	A	—	.63	-40°F	+212°F	Marine and Engine	88
MARINE AND ENGINE	1 5/8	4175EC Coolant Hose	88	2.0	2.02	P	P	15.0	.63	-40°F	+257°F	Marine and Engine	86
	1 5/8	4176HD Coolant Hose	106	7.0	2.13	P	P	14.0	.87	-40°F	+257°F	Marine and Engine	87
	1 5/8	4663K Fuel Fill Hose - Corrugated	20	30.0	1.90	C	A	5.5	.44	-40°F	+212°F	Marine and Engine	98
	1 5/8	Air Duct (5-10) SD	10	5.0	1.81	A	A	2.0	.28	-30°F	+250°F	Air Duct	46
MATERIAL HANDLING	1 5/8	Air Duct (8-20) SD	15	15.0	1.88	A	A	1.8	.51	-30°F	+250°F	Air Duct	47
	1 5/8	Engine Coolant Silicone	80	2.0	2.02	MQ	MQ	—	.61	-65°F	+347°F	Marine and Engine	90
	1 5/8	Green Stripe® Coolant and Air Hose	75	20.0	2.08	P	P	3.5	3.88	-40°F	+257°F	Marine and Engine	89
MINING	1 5/8	Marine Master™ Plus Wet Exhaust (15-100) SD	75	20.0	2.07	C	A	5.0	.75	-40°F	+212°F	Marine and Engine	94
	1 5/8	Marine Master™ Wet Exhaust 100D	100	—	1.91	P	P	—	7.63	-40°F	+257°F	Marine and Engine	92
OILFIELD	1 5/8	Marine Master™ Wet Exhaust 100SD	100	20.0	2.00	P	P	3.5	9.69	-40°F	+257°F	Marine and Engine	93
	1 5/8	Water Master® Slurry 150D AR	150	—	2.10	D	D	15.0	.74	-40°F	+150°F	Water	163
PETROLEUM	1 3/4	4169A Coolant Hose	75	1.0	2.14	C	A	—	.68	-40°F	+212°F	Marine and Engine	88
	1 3/4	4175EC Coolant Hose	75	1.0	2.14	P	P	15.0	.67	-40°F	+257°F	Marine and Engine	86
	1 3/4	4176HD Coolant Hose	100	5.0	2.26	P	P	15.0	.93	-40°F	+257°F	Marine and Engine	87
	1 3/4	4663K Fuel Fill Hose - Corrugated	20	30.0	2.02	C	A	6.0	.47	-40°F	+212°F	Marine and Engine	98
PRESSURE WASH AND WASHDOWN	1 3/4	Air Duct (5-10) SD	10	5.0	1.94	A	A	2.0	.30	-30°F	+250°F	Air Duct	46
	1 3/4	Air Duct (8-20) SD	15	15.0	2.00	A	A	1.8	.54	-30°F	+250°F	Air Duct	47
	1 3/4	Black Gold® Super-Vac® (60-150) SD	150	30.0	2.12	C	D	4.0	.84	-40°F	+180°F	Oilfield	122
STEAM	1 3/4	Engine Coolant Silicone	80	1.0	2.14	MQ	MQ	—	.65	-65°F	+347°F	Marine and Engine	90
	1 3/4	Green Stripe® Coolant and Air Hose	75	20.0	2.21	P	P	4.0	5.07	-40°F	+257°F	Marine and Engine	89
WATER	1 3/4	Marine Master™ Plus Wet Exhaust (15-100) SD	75	20.0	2.20	C	A	5.0	.80	-40°F	+212°F	Marine and Engine	94
	1 3/4	Marine Master™ Wet Exhaust 100D	100	—	2.03	P	P	—	8.15	-40°F	+257°F	Marine and Engine	92
CLAMPS	1 3/4	Marine Master™ Wet Exhaust 100SD	100	20.0	2.12	P	P	4.0	10.46	-40°F	+257°F	Marine and Engine	93
	1 3/4	MIL Low Pressure Fuel & Oil Hose	150	—	2.02	A	A	16.0	.81	-40°F	+250°F	Marine and Engine	85
COUPLINGS AND FERRULES	1 7/8	4169A Coolant Hose	75	—	2.26	C	A	—	.73	-40°F	+212°F	Marine and Engine	88
	1 7/8	4175EC Coolant Hose	75	—	2.26	P	P	—	.72	-40°F	+257°F	Marine and Engine	86
	1 7/8	4176HD Coolant Hose	94	4.0	2.38	P	P	—	.98	-40°F	+257°F	Marine and Engine	87
	1 7/8	4663K Fuel Fill Hose - Corrugated	20	30.0	2.14	C	A	6.0	.50	-40°F	+212°F	Marine and Engine	98
HOSE FINDER	1 7/8	Air Duct (5-10) SD	10	5.0	2.06	A	A	2.0	.32	-30°F	+250°F	Air Duct	46
	1 7/8	Air Duct (8-20) SD	15	15.0	2.12	A	A	1.8	.58	-30°F	+250°F	Air Duct	47
	1 7/8	Green Stripe® Coolant and Air Hose	60	20.0	2.33	P	P	4.5	5.24	-40°F	+257°F	Marine and Engine	89
CHEMICAL RESISTANCE TABLE	1 7/8	Marine Master™ Plus Wet Exhaust (15-100) SD	60	20.0	2.33	C	A	5.0	.85	-40°F	+212°F	Marine and Engine	94

## Hose Finder

Hose I.D. (in)	Name	Rated W.P. (psi)	Vacuum (In. Hg.)	Hose O.D. (in)	Tube Type	Cover Type	MBR (in)	Wt. (lbs/ft)	Temp Min. (°F)	Temp Max. (°F)	Hose Categories	Catalog Page No.
1 7/8	Marine Master™ Wet Exhaust 100D	100	—	2.19	P	P	—	8.63	-40°F	+257°F	Marine and Engine	92
1 7/8	Marine Master™ Wet Exhaust 100SD	100	20.0	2.24	P	P	4.5	11.09	-40°F	+257°F	Marine and Engine	93
1 7/8	Water Master® Slurry 150D AR	150	—	2.35	D	D	15.0	.88	-40°F	+150°F	Water	163
2	4169A Coolant Hose	60	—	2.39	C	A	—	.77	-40°F	+212°F	Marine and Engine	88
2	4175EC Coolant Hose	62	—	2.39	P	P	—	.76	-40°F	+257°F	Marine and Engine	86
2	4176HD Coolant Hose	88	3.0	2.51	P	P	—	1.00	-40°F	+257°F	Marine and Engine	87
2	4663K Fuel Fill Hose - Corrugated	20	30.0	2.25	C	A	7.0	.53	-40°F	+212°F	Marine and Engine	98
2	Ag Master™ PVC Solution (30-90) SD Clear	40	28.0	2.44	G	—	4.0	.57	-10°F	+130°F	Agriculture	42
2	Ag Master™ PVC Solution (30-90) SD Clear	70	28.0	2.36	G	—	6.0	.66	-10°F	+130°F	Agriculture	42
2	Ag Master™ PVC Solution (35-80) SD	60	28.0	2.49	P	G	9.0	.69	-30°F	+140°F	Agriculture	41
2	Ag Master™ PVC XTreme™ (90-100) SD	100	30.0	2.54	P	P	5.0	.73	-40°F	+140°F	Agriculture	40
2	Ag Master™ Solution 150SD	150	30.0	2.36	P	P	8.0	.79	-40°F	+180°F	Agriculture	39
2	Air Duct (5-10) SD	5	3.0	2.19	A	A	2.0	.33	-30°F	+250°F	Air Duct	46
2	Air Duct (8-20) SD	15	15.0	2.25	A	A	2.0	.60	-30°F	+250°F	Air Duct	47
2	Black Gold® ABS Chemical Plus XLPE 250SD	250	30.0	2.58	K	P	10.0	1.19	-40°F	+250°F	Oilfield	112
2	Black Gold® ABS Drill Water 300D	300	10.0	2.58	P	P	14.0	.94	-40°F	+150°F	Oilfield	114
2	Black Gold® ABS Drill Water 300SD	300	30.0	2.62	P	P	12.0	1.19	-40°F	+150°F	Oilfield	113
2	Black Gold® ABS Mud and Oil 300D	300	10.0	2.62	C	A	14.0	1.12	-40°F	+180°F	Oilfield	126
2	Black Gold® ABS Mud and Oil 300SD	300	30.0	2.87	C	A	24.0	1.88	-40°F	+180°F	Oilfield	125
2	Black Gold® ABS Potable Water 300D	300	—	2.69	D2	P	—	1.27	-40°F	+150°F	Oilfield	117
2	Black Gold® Fuel 300D	300	10.0	2.66	C	A	14.0	1.78	-40°F	+180°F	Oilfield	128
2	Black Gold® Fuel 300SD	300	30.0	2.78	C	A	10.0	1.60	-40°F	+180°F	Oilfield	127
2	Black Gold® Oilfield Service 400D	400	10.0	2.70	C	A	17.0	1.51	-40°F	+180°F	Oilfield	131
2	Black Gold® Oilfield Service 400SD	400	30.0	2.84	C	A	15.0	2.03	-40°F	+180°F	Oilfield	130
2	Black Gold® Oilfield Vacuum (100-150) SD	150	30.0	2.47	C	D	4.0	1.05	-40°F	+150°F	Oilfield	123
2	Black Gold® Potable Water (150-300) D	300	10.0	2.70	D2	P	14.0	1.49	-40°F	+150°F	Oilfield	118
2	Black Gold® Slim Hole Rotary (1500-5000)	3000	—	2.63	C	A	25.0	2.95	-40°F	+180°F	Oilfield	115
2	Black Gold® Slim Hole Rotary (1500-5000)	5000	—	2.80	C	A	25.0	4.94	-40°F	+180°F	Oilfield	115
2	Black Gold® Super-Vac® (60-150) SD	150	30.0	2.47	C	D	4.0	.94	-40°F	+180°F	Oilfield	122
2	Black Gold® Super-Vac® MegaFlex® (100-200) SD	150	30.0	2.39	C	D	2.0	.80	-40°F	+180°F	Oilfield	124
2	Bulk Master™ (4-24) SD	8	20.0	2.39	D3	D	8.0	.75	-40°F	+150°F	Material Handling	103
2	Bulk Master™ Hot Air Blower (40-130) SD HT	125	30.0	2.58	P	P	9.0	1.00	-40°F	+350°F	Material Handling	102
2	Bulk Master™ Plus (35-60) SD	60	30.0	2.77	D3	D	16.0	1.74	-40°F	+150°F	Material Handling	101
2	Bulk Master™ PVC (25-40) SD AR	35	28.0	2.41	C	G	4.0	.54	-30°F	+140°F	Material Handling	105
2	Bulk Master™ Sand Blast (120-150) D	120	5.0	2.94	D3	D	20.0	2.00	-40°F	+150°F	Material Handling	104
2	Chem Master™ EPDM (125-150) SD	150	30.0	2.54	P	P	6.0	1.07	-40°F	+250°F	Chemical	66

AGRICULTURE

AIR BREATHING

AIR DUCT

AIR AND MULTI-PURPOSE

CHEMICAL

FOOD AND BEVERAGE

MARINE AND ENGINE

MATERIAL HANDLING

MINING

OILFIELD

PETROLEUM

PRESSURE WASH AND WASHDOWN

STEAM

WATER

CLAMPS

COUPLINGS AND FERRULES

HOSE FINDER

CHEMICAL RESISTANCE TABLE

## Hose Finder

	Hose I.D. (in)	Name	Rated W.P. (psi)	Vacuum (In. Hg.)	Hose O.D. (in)	Tube Type	Cover Type	MBR (in)	Wt. (lbs/ft)	Temp Min. (°F)	Temp Max. (°F)	Hose Categories	Catalog Page No.
AGRICULTURE													
AIR BREATHING													
AIR DUCT													
AIR AND MULTI-PURPOSE	2	Chem Master™ Plus CPE (150-200) SD MegaFlex®	200	30.0	2.48	J	P	4.0	1.01	-40°F	+275°F	Chemical	65
	2	Chem Master™ Plus UHMWPE (125-200) SD	200	30.0	2.50	L	P	9.0	1.08	-40°F	+212°F	Chemical	64
	2	Chem Master™ Plus XLPE (150-200) SD	200	30.0	2.54	K	P	9.0	1.08	-40°F	+250°F	Chemical	62
CHEMICAL	2	Chem Master™ Plus XLPE 200SD CR	200	20.0	2.63	K	P	9.0	1.08	-40°F	+250°F	Chemical	63
	2	Chem Master™ XTreme™ FEP (125-200) SD	200	30.0	2.55	T	P	9.0	1.14	-40°F	+300°F	Chemical	60
FOOD AND BEVERAGE	2	Chem Master™ XTreme™ FEP 200SD CR	200	20.0	2.58	T	P	9.0	1.14	-40°F	+300°F	Chemical	61
	2	Engine Coolant Silicone	75	—	2.39	MQ	MQ	—	.73	-65°F	+347°F	Marine and Engine	90
MARINE AND ENGINE	2	Food Master® Beverage 150SD CR	150	30.0	2.50	S	P	12.0	.96	-40°F	+212°F	Food and Beverage	72
	2	Food Master® Beverage 250SD CR	250	30.0	2.62	S	P	6.0	1.32	-40°F	+230°F	Food and Beverage	71
	2	Food Master® Dry Goods (50-150) SD	150	30.0	2.75	D2	P	12.0	1.76	-40°F	+150°F	Food and Beverage	76
MATERIAL HANDLING	2	Food Master® Oils and Dairy 150D	150	—	2.54	C2	C2	24.0	1.25	-40°F	+230°F	Food and Beverage	74
	2	Food Master® Oils and Dairy 150SD	150	30.0	2.55	C2	C2	6.0	1.50	-40°F	+230°F	Food and Beverage	73
MINING	2	Food Master® Oils and Dairy 150SD MegaFlex®	150	30.0	2.49	C2	C2	4.0	1.14	-40°F	+230°F	Food and Beverage	75
	2	Food Master® PVC (20-65) Clear	35	—	2.50	G	G	—	.85	-25°F	+150°F	Food and Beverage	78
OILFIELD	2	Food Master® PVC (35-50) SD Clear	40	28.0	2.44	G	G	4.0	.57	-10°F	+130°F	Food and Beverage	81
	2	Food Master® PVC (50-100) SD Clear	70	28.0	2.39	G	G	6.0	.71	-10°F	+130°F	Food and Beverage	80
PETROLEUM	2	Food Master® PVC Clear Tubing (75-250) Braid	75	—	2.50	G	G	—	1.00	-10°F	+130°F	Food and Beverage	79
	2	Food Master® PVC Dry Goods (35-40) SD Clear	40	28.0	2.37	G	G	4.0	.58	-10°F	+130°F	Food and Beverage	82
PRESSURE WASH AND WASHDOWN	2	Food Master® XTreme™ 250SD CR	250	30.0	2.62	S	P	6.0	1.19	-40°F	+230°F	Food and Beverage	70
	2	Fuel Master™ 100SD	100	30.0	2.48	C	C2	4.0	1.11	-40°F	+180°F	Petroleum	141
	2	Fuel Master™ 150D	150	—	2.44	C	A	—	.92	-40°F	+180°F	Petroleum	140
	2	Fuel Master™ 150SD	150	30.0	2.52	C	A	5.0	1.08	-40°F	+180°F	Petroleum	137
	2	Fuel Master™ 150SD	150	30.0	2.52	C	A	6.0	1.34	-40°F	+180°F	Petroleum	137
STEAM	2	Fuel Master™ 150SD LT MegaFlex®	150	30.0	2.38	C	A	2.0	1.13	-65°F	+180°F	Petroleum	139
WATER	2	Fuel Master™ 150SD MegaFlex®	150	30.0	2.39	C	A	2.0	.86	-40°F	+180°F	Petroleum	138
	2	Fuel Master™ PVC Vapor Recovery 5SD	5	—	2.43	U	G	2.0	.48	-30°F	+140°F	Petroleum	144
CLAMPS	2	Fuel Master™ XTreme™ 150SD	150	30.0	2.52	C	C2	6.0	.59	-30°F	+180°F	Petroleum	135
	2	Fuel Master™ XTreme™ 150SD MegaFlex®	150	30.0	2.45	C	C2	2.0	.94	-30°F	+180°F	Petroleum	136
COUPLINGS AND FERRULES	2	Green Stripe® Coolant and Air Hose	60	20.0	2.46	P	P	4.5	5.07	-40°F	+257°F	Marine and Engine	89
	2	LP350	350	10.0	2.86	A	A	14.0	1.81	-40°F	+180°F	Petroleum	148
	2	Marine Master™ Plus Wet Exhaust (15-100) SD	62	20.0	2.45	C	A	5.0	.90	-40°F	+212°F	Marine and Engine	94
HOSE FINDER	2	Marine Master™ Wet Exhaust 100D	100	—	2.32	P	P	—	9.18	-40°F	+257°F	Marine and Engine	92
	2	Marine Master™ Wet Exhaust 100SD	100	20.0	2.36	P	P	5.0	11.90	-40°F	+257°F	Marine and Engine	93
CHEMICAL RESISTANCE TABLE	2	MIL Low Pressure Fuel & Oil Hose	150	—	2.27	A	A	20.0	.78	-40°F	+250°F	Marine and Engine	85
	2	Mine Master™ Air Drill 500	500	15.0	2.77	A	C2	14.0	1.26	-30°F	+212°F	Mining	109

## Hose Finder

Hose I.D. (in)	Name	Rated W.P. (psi)	Vacuum (In. Hg.)	Hose O.D. (in)	Tube Type	Cover Type	MBR (in)	Wt. (lbs/ft)	Temp Min. (°F)	Temp Max. (°F)	Hose Categories	Catalog Page No.
2	Mine Master™ Air Drill 500 FR	500	15.0	2.50	C	C2	14.0	1.39	-22°F	+180°F	Mining	110
2	Mine Master™ Air Drill 600HT	600	—	2.62	J	J	16.0	1.51	-40°F	+300°F	Mining	108
2	Mine Master™ Rock Dust 100SD	100	30.0	2.41	D	C2	10.0	.89	-40°F	+180°F	Mining	111
2	Mine Master™ Spray 1000	1000	10.0	2.45	P	C2	25.0	1.47	-40°F	+212°F	Mining	106
2	Plant Master® Plus (200-300)	200	4.0	2.56	B1	D3	16.5	1.28	-40°F	+200°F	Air and Multi-Purpose	54
2	Plant Master® Steam 250	250	10.0	2.66	P2	P2	25.0	1.57	-40°F	+450°F	Steam	158
2	Plant Master® Steam Plus 250	250	10.0	2.66	P2	B1	25.0	1.80	-40°F	+450°F	Steam	159
2	Plant Master® XTreme™ 501 AR	501	10.0	2.64	C	C4	14.0	1.35	-40°F	+212°F	Air and Multi-Purpose	49
2	Water Master® (100-150) SD	150	30.0	2.36	P	P	8.0	.76	-32°F	+200°F	Water	161
2	Water Master® (100-150) SD AR	150	30.0	2.46	P	D	10.0	.99	-40°F	+180°F	Water	160
2	Water Master® (90-150) D	150	—	2.32	P	P	—	.65	-40°F	+180°F	Water	165
2	Water Master® 150D AR	150	—	2.33	P	D	20.0	.65	-40°F	+180°F	Water	164
2	Water Master® 150D AR	150	—	2.41	P	D	20.0	.84	-40°F	+180°F	Water	164
2	Water Master® Plus PVC Layflat (100-150) D	150	—	2.24	G	G	—	.36	-10°F	+150°F	Water	168
2	Water Master® PVC (40-100) SD	100	28.0	2.60	G1	G1	4.0	.70	-13°F	+140°F	Water	166
2	Water Master® PVC Layflat (45-75) D	65	—	2.16	G	G	—	.21	+25°F	+120°F	Water	167
2	Water Master® Slurry 150D AR	150	—	2.48	D	D	20.0	.93	-40°F	+150°F	Water	163
2	Water Master® Water Suction/Discharge 150SD	150	30.0	2.36	P	P	8.0	1.08	-40°F	+180°F	Water	162
2 1/8	4169A Coolant Hose	60	—	2.52	C	A	—	.88	-40°F	+212°F	Marine and Engine	88
2 1/8	4175EC Coolant Hose	62	—	2.52	P	P	—	.79	-40°F	+257°F	Marine and Engine	86
2 1/8	Air Duct (5-10) SD	5	3.0	2.31	A	A	2.5	.35	-30°F	+250°F	Air Duct	46
2 1/8	Air Duct (8-20) SD	10	15.0	2.31	A	A	2.5	.63	-30°F	+250°F	Air Duct	47
2 1/8	Engine Coolant Silicone	75	—	2.52	MQ	MQ	—	.77	-65°F	+347°F	Marine and Engine	90
2 1/8	Green Stripe® Coolant and Air Hose	55	20.0	2.58	P	P	5.5	5.35	-40°F	+257°F	Marine and Engine	89
2 1/8	Marine Master™ Plus Wet Exhaust (15-100) SD	55	20.0	2.58	C	A	6.0	.95	-40°F	+212°F	Marine and Engine	94
2 1/8	Marine Master™ Wet Exhaust 100D	100	—	2.45	P	P	—	9.69	-40°F	+257°F	Marine and Engine	92
2 1/8	Marine Master™ Wet Exhaust 100SD	100	20.0	2.49	P	P	5.5	12.98	-40°F	+257°F	Marine and Engine	93
2 1/4	4169A Coolant Hose	60	—	2.64	C	A	—	.93	-40°F	+212°F	Marine and Engine	88
2 1/4	4175EC Coolant Hose	62	—	2.64	P	P	—	.84	-40°F	+257°F	Marine and Engine	86
2 1/4	4176HD Coolant Hose	88	1.0	2.76	P	P	—	1.03	-40°F	+257°F	Marine and Engine	87
2 1/4	4663K Fuel Fill Hose - Corrugated	20	30.0	2.50	C	A	8.0	.59	-40°F	+212°F	Marine and Engine	98
2 1/4	Air Duct (5-10) SD	5	3.0	2.44	A	A	2.5	.37	-30°F	+250°F	Air Duct	46
2 1/4	Air Duct (8-20) SD	10	15.0	2.50	A	A	2.5	.67	-30°F	+250°F	Air Duct	47
2 1/4	Engine Coolant Silicone	75	—	2.64	MQ	MQ	—	.81	-65°F	+347°F	Marine and Engine	90
2 1/4	Green Stripe® Coolant and Air Hose	55	20.0	2.71	P	P	5.5	5.62	-40°F	+257°F	Marine and Engine	89
2 1/4	Marine Master™ Plus Wet Exhaust (15-100) SD	55	20.0	2.71	C	A	6.0	1.00	-40°F	+212°F	Marine and Engine	94
2 1/4	Marine Master™ Wet Exhaust 100D	100	—	2.57	P	P	—	10.00	-40°F	+257°F	Marine and Engine	92
2 1/4	Marine Master™ Wet Exhaust 100SD	100	20.0	2.63	P	P	6.0	13.04	-40°F	+257°F	Marine and Engine	93
2 1/4	MIL Low Pressure Fuel & Oil Hose	100	—	2.52	A	A	20.0	1.01	-40°F	+250°F	Marine and Engine	85
2 3/8	4169A Coolant Hose	60	—	2.76	C	A	—	.97	-40°F	+212°F	Marine and Engine	88

AGRICULTURE

AIR BREATHING

AIR DUCT

AIR AND MULTI-PURPOSE

CHEMICAL

FOOD AND BEVERAGE

MARINE AND ENGINE

MATERIAL HANDLING

MINING

OILFIELD

PETROLEUM

PRESSURE WASH AND WASHDOWN

STEAM

WATER

CLAMPS

COUPLINGS AND FERRULES

HOSE FINDER

CHEMICAL RESISTANCE TABLE

## Hose Finder

	Hose I.D. (in)	Name	Rated W.P. (psi)	Vacuum (In. Hg.)	Hose O.D. (in)	Tube Type	Cover Type	MBR (in)	Wt. (lbs/ft)	Temp Min. (°F)	Temp Max. (°F)	Hose Categories	Catalog Page No.
AGRICULTURE	2 3/8	4175EC Coolant Hose	62	—	2.76	P	P	—	.88	-40°F	+257°F	Marine and Engine	86
AIR BREATHING	2 3/8	4176HD Coolant Hose	81	—	2.88	P	P	—	1.07	-40°F	+257°F	Marine and Engine	87
AIR DUCT	2 3/8	Air Duct (5-10) SD	5	3.0	2.56	A	A	2.5	.39	-30°F	+250°F	Air Duct	46
AIR AND MULTI-PURPOSE	2 3/8	Air Duct (8-20) SD	10	15.0	2.62	A	A	2.5	.71	-30°F	+250°F	Air Duct	47
	2 3/8	Engine Coolant Silicone	65	—	2.76	MQ	MQ	—	.91	-65°F	+347°F	Marine and Engine	90
CHEMICAL	2 3/8	Green Stripe® Coolant and Air Hose	50	20.0	2.83	P	P	6.5	5.91	-40°F	+257°F	Marine and Engine	89
	2 3/8	Marine Master™ Plus Wet Exhaust (15-100) SD	50	20.0	2.83	C	A	7.0	1.06	-40°F	+212°F	Marine and Engine	94
FOOD AND BEVERAGE	2 3/8	Marine Master™ Wet Exhaust 100D	100	—	2.69	P	P	—	10.70	-40°F	+257°F	Marine and Engine	92
	2 3/8	Marine Master™ Wet Exhaust 100SD	100	20.0	2.75	P	P	6.5	14.45	-40°F	+257°F	Marine and Engine	93
MARINE AND ENGINE	2 1/2	4169A Coolant Hose	60	—	2.89	C	A	—	1.02	-40°F	+212°F	Marine and Engine	88
	2 1/2	4175EC Coolant Hose	62	—	2.89	P	P	—	.92	-40°F	+257°F	Marine and Engine	86
	2 1/2	4176HD Coolant Hose	75	—	3.01	P	P	—	1.09	-40°F	+257°F	Marine and Engine	87
	2 1/2	4663K Fuel Fill Hose - Corrugated	20	30.0	2.75	C	A	12.0	.65	-40°F	+212°F	Marine and Engine	98
MATERIAL HANDLING	2 1/2	Ag Master™ PVC Solution (30-90) SD Clear	65	28.0	2.90	G	—	8.0	.95	-10°F	+130°F	Agriculture	42
	2 1/2	Ag Master™ PVC Solution (35-80) SD	50	28.0	3.00	P	G	11.0	.91	-30°F	+140°F	Agriculture	41
MINING	2 1/2	Ag Master™ Solution 150SD	150	30.0	2.96	P	P	10.0	1.38	-40°F	+180°F	Agriculture	39
	2 1/2	Air Duct (5-10) SD	5	3.0	2.69	A	A	2.5	.41	-30°F	+250°F	Air Duct	46
	2 1/2	Air Duct (8-20) SD	10	15.0	2.75	A	A	2.5	.74	-30°F	+250°F	Air Duct	47
	2 1/2	Black Gold® Fuel 300D	300	10.0	3.16	C	A	17.0	2.16	-40°F	+180°F	Oilfield	128
OILFIELD	2 1/2	Black Gold® Slim Hole Rotary (1500-5000)	2500	—	3.38	C	A	30.0	3.60	-40°F	+180°F	Oilfield	115
	2 1/2	Black Gold® Super-Vac® (60-150) SD	150	30.0	2.99	C	D	5.0	1.52	-40°F	+180°F	Oilfield	122
PETROLEUM	2 1/2	Bulk Master™ (4-24) SD	9	20.0	2.89	D3	D	9.0	.91	-40°F	+150°F	Material Handling	103
	2 1/2	Bulk Master™ Hot Air Blower (40-130) SD HT	110	30.0	3.08	P	P	14.0	1.43	-40°F	+350°F	Material Handling	102
PRESSURE WASH AND WASHDOWN	2 1/2	Bulk Master™ Plus (35-60) SD	60	30.0	3.27	D3	D	20.0	1.65	-40°F	+150°F	Material Handling	101
	2 1/2	Bulk Master™ PVC (25-40) SD AR	35	28.0	2.98	C	G	5.0	.77	-30°F	+140°F	Material Handling	105
STEAM	2 1/2	Chem Master™ EPDM (125-150) SD	150	30.0	3.05	P	P	9.0	1.34	-40°F	+250°F	Chemical	66
	2 1/2	Chem Master™ Plus CPE (150-200) SD MegaFlex®	150	30.0	2.98	J	P	5.0	1.23	-40°F	+275°F	Chemical	65
WATER	2 1/2	Chem Master™ Plus UHMWPE (125-200) SD	150	30.0	3.01	L	P	12.0	1.39	-40°F	+212°F	Chemical	64
	2 1/2	Chem Master™ Plus XLPE (150-200) SD	150	30.0	3.05	K	P	12.0	1.28	-40°F	+250°F	Chemical	62
CLAMPS	2 1/2	Chem Master™ XTreme™ FEP (125-200) SD	150	30.0	3.07	T	P	12.0	1.44	-40°F	+300°F	Chemical	60
	2 1/2	Engine Coolant Silicone	65	—	2.89	MQ	MQ	—	.96	-65°F	+347°F	Marine and Engine	90
COUPLINGS AND FERRULES	2 1/2	Food Master® Beverage 150SD CR	150	30.0	3.11	S	P	22.0	1.62	-40°F	+212°F	Food and Beverage	72
	2 1/2	Food Master® Beverage 250SD CR	250	30.0	3.25	S	P	12.0	1.60	-40°F	+230°F	Food and Beverage	71
	2 1/2	Food Master® Dry Goods (50-150) SD	125	30.0	3.23	D2	P	15.0	2.00	-40°F	+150°F	Food and Beverage	76
HOSE FINDER	2 1/2	Food Master® Oils and Dairy 150D	150	—	3.06	C2	C2	30.0	1.66	-40°F	+230°F	Food and Beverage	74
	2 1/2	Food Master® Oils and Dairy 150SD	150	30.0	3.08	C2	C2	12.0	1.98	-40°F	+230°F	Food and Beverage	73
CHEMICAL RESISTANCE TABLE	2 1/2	Food Master® PVC (35-50) SD Clear	40	28.0	2.98	G	G	5.0	.77	-10°F	+130°F	Food and Beverage	81
	2 1/2	Food Master® PVC (50-100) SD Clear	65	28.0	2.92	G	G	8.0	.97	-10°F	+130°F	Food and Beverage	80

## Hose Finder

Hose I.D. (in)	Name	Rated W.P. (psi)	Vacuum (In. Hg.)	Hose O.D. (in)	Tube Type	Cover Type	MBR (in)	Wt. (lbs/ft)	Temp Min. (°F)	Temp Max. (°F)	Hose Categories	Catalog Page No.
2 1/2	Food Master® PVC Dry Goods (35-40) SD Clear	40	28.0	3.01	G	G	4.0	.85	-10°F	+130°F	Food and Beverage	82
2 1/2	Food Master® XTreme™ 250SD CR	250	30.0	3.25	S	P	12.0	1.81	-40°F	+230°F	Food and Beverage	70
2 1/2	Fuel Master™ 150SD	150	30.0	3.05	C	A	8.0	1.40	-40°F	+180°F	Petroleum	137
2 1/2	Fuel Master™ XTreme™ 150SD	150	30.0	3.05	C	C2	8.0	1.47	-30°F	+180°F	Petroleum	135
2 1/2	Green Stripe® Coolant and Air Hose	50	20.0	2.96	P	P	6.5	6.15	-40°F	+257°F	Marine and Engine	89
2 1/2	Marine Master™ Plus Wet Exhaust (15-100) SD	50	20.0	2.96	C	A	7.0	1.11	-40°F	+212°F	Marine and Engine	94
2 1/2	Marine Master™ Wet Exhaust 100D	100	—	2.82	P	P	—	11.24	-40°F	+257°F	Marine and Engine	92
2 1/2	Marine Master™ Wet Exhaust 100SD	100	20.0	2.90	P	P	6.5	15.14	-40°F	+257°F	Marine and Engine	93
2 1/2	MIL Low Pressure Fuel & Oil Hose	100	—	2.77	A	A	25.0	1.10	-40°F	+250°F	Marine and Engine	85
2 1/2	Mine Master™ Air Drill 500	500	10.0	3.46	A	C2	30.0	3.28	-30°F	+212°F	Mining	109
2 1/2	Mine Master™ Air Drill 500 FR	500	10.0	3.14	C	C2	30.0	2.15	-22°F	+180°F	Mining	110
2 1/2	Mine Master™ Air Drill 600HT	600	—	3.12	J	J	18.0	1.89	-40°F	+300°F	Mining	108
2 1/2	Mine Master™ Longwall Emulsion 1000	1000	10.0	3.34	A	C2	20.0	3.17	-40°F	+212°F	Mining	107
2 1/2	Mine Master™ Rock Dust 100SD	100	30.0	2.92	D	C2	12.0	.98	-40°F	+180°F	Mining	111
2 1/2	Water Master® (100-150) SD	150	30.0	2.96	P	P	10.0	1.06	-32°F	+200°F	Water	161
2 1/2	Water Master® (100-150) SD AR	150	30.0	3.02	P	D	12.0	1.44	-40°F	+180°F	Water	160
2 1/2	Water Master® (90-150) D	150	—	2.82	P	P	—	.80	-40°F	+180°F	Water	165
2 1/2	Water Master® 150D AR	150	—	2.83	P	D	25.0	.90	-40°F	+180°F	Water	164
2 1/2	Water Master® 150D AR	150	—	2.91	P	D	25.0	1.02	-40°F	+180°F	Water	164
2 1/2	Water Master® Plus PVC Layflat (100-150) D	150	—	2.79	G	G	—	.41	-10°F	+150°F	Water	168
2 1/2	Water Master® PVC Layflat (45-75) D	60	—	2.55	G	G	—	.28	+25°F	+120°F	Water	167
2 1/2	Water Master® Slurry 150D AR	150	—	2.99	D	D	25.0	1.14	-40°F	+150°F	Water	163
2 5/8	4169A Coolant Hose	60	—	3.02	C	A	—	1.07	-40°F	+212°F	Marine and Engine	88
2 5/8	4175EC Coolant Hose	62	—	3.02	P	P	—	.96	-40°F	+257°F	Marine and Engine	86
2 5/8	4176HD Coolant Hose	69	—	3.13	P	P	—	1.16	-40°F	+257°F	Marine and Engine	87
2 5/8	Air Duct (5-10) SD	5	3.0	2.81	A	A	2.8	.43	-30°F	+250°F	Air Duct	46
2 5/8	Air Duct (8-20) SD	10	15.0	2.88	A	A	3.0	.78	-30°F	+250°F	Air Duct	47
2 5/8	Green Stripe® Coolant and Air Hose	40	15.0	3.08	P	P	7.5	6.45	-40°F	+257°F	Marine and Engine	89
2 5/8	Marine Master™ Plus Wet Exhaust (15-100) SD	40	15.0	3.08	C	A	9.0	1.16	-40°F	+212°F	Marine and Engine	94
2 5/8	Marine Master™ Wet Exhaust 100D	100	—	2.95	P	P	—	11.79	-40°F	+257°F	Marine and Engine	92
2 5/8	Marine Master™ Wet Exhaust 100SD	100	15.0	3.02	P	P	7.0	15.80	-40°F	+257°F	Marine and Engine	93
2 3/4	4169A Coolant Hose	60	—	3.14	C	A	—	1.12	-40°F	+212°F	Marine and Engine	88
2 3/4	4175EC Coolant Hose	62	—	3.14	P	P	—	1.00	-40°F	+257°F	Marine and Engine	86
2 3/4	4176HD Coolant Hose	63	—	3.26	P	P	—	1.19	-40°F	+257°F	Marine and Engine	87
2 3/4	Air Duct (5-10) SD	5	3.0	2.94	A	A	2.8	.44	-30°F	+250°F	Air Duct	46
2 3/4	Air Duct (8-20) SD	10	15.0	3.00	A	A	7.0	.81	-30°F	+250°F	Air Duct	47
2 3/4	Engine Coolant Silicone	50	—	3.14	MQ	MQ	—	1.04	-65°F	+347°F	Marine and Engine	90
2 3/4	Green Stripe® Coolant and Air Hose	40	15.0	3.21	P	P	7.5	6.30	-40°F	+257°F	Marine and Engine	89
2 3/4	Marine Master™ Plus Wet Exhaust (15-100) SD	40	15.0	3.21	C	A	10.0	1.21	-40°F	+212°F	Marine and Engine	94
2 3/4	Marine Master™ Wet Exhaust 100D	100	—	3.09	P	P	—	12.29	-40°F	+257°F	Marine and Engine	92

AGRICULTURE

AIR BREATHING

AIR DUCT

AIR AND MULTI-PURPOSE

CHEMICAL

FOOD AND BEVERAGE

MARINE AND ENGINE

MATERIAL HANDLING

MINING

OILFIELD

PETROLEUM

PRESSURE WASH AND WASHDOWN

STEAM

WATER

CLAMPS

COUPLINGS AND FERRULES

HOSE FINDER

CHEMICAL RESISTANCE TABLE

## Hose Finder

	Hose I.D. (in)	Name	Rated W.P. (psi)	Vacuum (In. Hg.)	Hose O.D. (in)	Tube Type	Cover Type	MBR (in)	Wt. (lbs/ft)	Temp Min. (°F)	Temp Max. (°F)	Hose Categories	Catalog Page No.
AGRICULTURE													
AIR BREATHING													
AIR DUCT													
AIR AND MULTI-PURPOSE	2 3/4	Marine Master™ Wet Exhaust 100SD	100	15.0	3.22	P	P	7.5	16.48	-40°F	+257°F	Marine and Engine	93
	2 7/8	4169A Coolant Hose	55	—	3.26	C	A	—	1.16	-40°F	+212°F	Marine and Engine	88
	2 7/8	4175EC Coolant Hose	56	—	3.26	P	P	—	1.05	-40°F	+257°F	Marine and Engine	86
	2 7/8	4176HD Coolant Hose	63	—	3.38	P	P	—	1.26	-40°F	+257°F	Marine and Engine	87
CHEMICAL	2 7/8	Green Stripe® Coolant and Air Hose	40	15.0	3.33	P	P	9.0	7.01	-40°F	+257°F	Marine and Engine	89
	2 7/8	Marine Master™ Plus Wet Exhaust (15-100) SD	40	15.0	3.33	C	A	11.0	1.26	-40°F	+212°F	Marine and Engine	94
FOOD AND BEVERAGE	2 7/8	Marine Master™ Wet Exhaust 100D	100	—	3.23	P	P	—	12.80	-40°F	+257°F	Marine and Engine	92
	2 7/8	Marine Master™ Wet Exhaust 100SD	100	15.0	3.42	P	P	8.0	21.06	-40°F	+257°F	Marine and Engine	93
	3	4169A Coolant Hose	50	—	3.39	C	A	—	1.20	-40°F	+212°F	Marine and Engine	88
	3	4175EC Coolant Hose	50	—	3.39	P	P	—	1.09	-40°F	+257°F	Marine and Engine	86
MARINE AND ENGINE	3	4176HD Coolant Hose	63	—	3.51	P	P	—	1.30	-40°F	+257°F	Marine and Engine	87
	3	4663K Fuel Fill Hose - Corrugated	20	30.0	3.27	C	A	—	.84	-40°F	+212°F	Marine and Engine	98
MATERIAL HANDLING	3	Ag Master™ PVC Solution (30-90) SD Clear	35	28.0	3.54	G	—	6.0	1.04	-10°F	+130°F	Agriculture	42
	3	Ag Master™ PVC Solution (30-90) SD Clear	55	28.0	3.44	G	—	9.0	1.25	-10°F	+130°F	Agriculture	42
MINING	3	Ag Master™ PVC Solution (35-80) SD	50	28.0	3.60	P	G	12.0	1.10	-30°F	+140°F	Agriculture	41
	3	Ag Master™ PVC XTreme™ (90-100) SD	90	30.0	3.64	P	P	7.0	1.25	-40°F	+140°F	Agriculture	40
	3	Ag Master™ Solution 150SD	150	30.0	3.54	P	P	14.0	1.82	-40°F	+180°F	Agriculture	39
OILFIELD	3	Air Duct (5-10) SD	5	3.0	3.19	A	A	3.0	.90	-30°F	+250°F	Air Duct	46
	3	Air Duct (8-20) SD	10	7.0	3.25	A	A	10.0	.88	-30°F	+250°F	Air Duct	47
PETROLEUM	3	Black Gold® ABS Bulk Material (250-300) D	300	10.0	3.98	D3	D	21.0	2.64	-40°F	+150°F	Oilfield	120
	3	Black Gold® ABS Bulk Material 300SD	300	29.0	4.23	D3	D	32.0	3.47	-40°F	+150°F	Oilfield	119
PRESSURE WASH AND WASHDOWN	3	Black Gold® ABS Chemical Plus XLPE 250SD	250	30.0	3.71	K	P	18.0	2.37	-40°F	+250°F	Oilfield	112
	3	Black Gold® ABS Drill Water 300D	300	10.0	3.64	P	P	21.0	1.49	-40°F	+150°F	Oilfield	114
	3	Black Gold® ABS Drill Water 300SD	300	30.0	3.62	P	P	24.0	2.62	-40°F	+150°F	Oilfield	113
STEAM	3	Black Gold® ABS Mud and Oil 300D	300	10.0	3.62	C	A	21.0	1.94	-40°F	+180°F	Oilfield	126
	3	Black Gold® ABS Mud and Oil 300SD	300	30.0	3.85	C	A	32.0	2.83	-40°F	+180°F	Oilfield	125
WATER	3	Black Gold® ABS Potable Water 300D	300	—	3.74	D2	P	—	1.82	-40°F	+150°F	Oilfield	117
	3	Black Gold® Fuel 300D	300	10.0	3.70	C	A	21.0	2.45	-40°F	+180°F	Oilfield	128
	3	Black Gold® Fuel 300SD	300	30.0	3.86	C	A	18.0	2.59	-40°F	+180°F	Oilfield	127
CLAMPS	3	Black Gold® Oilfield Service 400D	400	10.0	3.67	C	A	22.0	1.51	-40°F	+180°F	Oilfield	131
	3	Black Gold® Oilfield Service 400D UltraBraid®	400	10.0	3.65	C	C4	22.0	1.95	-40°F	+180°F	Oilfield	129
COUPLINGS AND FERRULES	3	Black Gold® Oilfield Service 400SD	400	30.0	4.00	C	A	20.0	3.66	-40°F	+180°F	Oilfield	130
	3	Black Gold® Oilfield Vacuum (100-150) SD	150	30.0	3.50	C	D	6.0	2.17	-40°F	+150°F	Oilfield	123
HOSE FINDER	3	Black Gold® Potable Water (150-300) D	200	10.0	3.70	D2	P	21.0	2.15	-40°F	+150°F	Oilfield	118
	3	Black Gold® Slim Hole Rotary (1500-5000)	2000	—	3.90	C	A	36.0	4.74	-40°F	+180°F	Oilfield	115
CHEMICAL RESISTANCE TABLE	3	Black Gold® Super-Vac® (60-150) SD	150	30.0	3.52	C	D	6.0	1.77	-40°F	+180°F	Oilfield	122
	3	Black Gold® Super-Vac® MegaFlex® (100-200) SD	150	30.0	3.47	C	D	3.0	1.33	-40°F	+180°F	Oilfield	124

## Hose Finder

Hose I.D. (in)	Name	Rated W.P. (psi)	Vacuum (In. Hg.)	Hose O.D. (in)	Tube Type	Cover Type	MBR (in)	Wt. (lbs/ft)	Temp Min. (°F)	Temp Max. (°F)	Hose Categories	Catalog Page No.
3	Bulk Master™ (4-24) SD	12	20.0	3.39	D3	D	10.0	1.03	-40°F	+150°F	Material Handling	103
3	Bulk Master™ Dry Cement (20-75) D	75	—	3.47	D3	D	36.0	1.30	-40°F	+150°F	Material Handling	100
3	Bulk Master™ Hot Air Blower (40-130) SD HT	100	30.0	3.64	P	P	18.0	1.63	-40°F	+350°F	Material Handling	102
3	Bulk Master™ Plus (35-60) SD	60	30.0	3.81	D3	D	24.0	2.66	-40°F	+150°F	Material Handling	101
3	Bulk Master™ PVC (25-40) SD AR	30	28.0	3.87	C	G	6.0	1.05	-30°F	+140°F	Material Handling	105
3	Chem Master™ EPDM (125-150) SD	150	30.0	3.60	P	P	11.0	1.70	-40°F	+250°F	Chemical	66
3	Chem Master™ Plus CPE (150-200) SD MegaFlex®	150	30.0	3.48	J	P	8.0	1.61	-40°F	+275°F	Chemical	65
3	Chem Master™ Plus UHMWPE (125-200) SD	150	30.0	3.53	L	P	18.0	1.76	-40°F	+212°F	Chemical	64
3	Chem Master™ Plus XLPE (150-200) SD	150	30.0	3.58	K	P	18.0	1.81	-40°F	+250°F	Chemical	62
3	Chem Master™ XTreme™ FEP (125-200) SD	150	30.0	3.59	T	P	18.0	1.77	-40°F	+300°F	Chemical	60
3	Engine Coolant Silicone	50	—	3.39	MQ	MQ	—	1.17	-65°F	+347°F	Marine and Engine	90
3	Food Master® Beverage 150SD CR	150	30.0	3.75	S	P	20.0	2.13	-40°F	+212°F	Food and Beverage	72
3	Food Master® Beverage 250SD CR	250	30.0	3.86	S	P	18.0	2.20	-40°F	+230°F	Food and Beverage	71
3	Food Master® Dry Goods (50-150) SD	100	30.0	3.75	D2	P	18.0	2.13	-40°F	+150°F	Food and Beverage	76
3	Food Master® Oils and Dairy 150D	150	—	3.56	C2	C2	36.0	1.90	-40°F	+230°F	Food and Beverage	74
3	Food Master® Oils and Dairy 150SD	150	30.0	3.58	C2	C2	18.0	2.35	-40°F	+230°F	Food and Beverage	73
3	Food Master® Oils and Dairy 150SD MegaFlex®	150	30.0	3.56	C2	C2	9.0	1.92	-40°F	+230°F	Food and Beverage	75
3	Food Master® PVC (35-50) SD Clear	35	28.0	3.54	G	G	6.0	1.04	-10°F	+130°F	Food and Beverage	81
3	Food Master® PVC (50-100) SD Clear	60	28.0	3.46	G	G	9.0	1.27	-10°F	+130°F	Food and Beverage	80
3	Food Master® PVC Dry Goods (35-40) SD Clear	35	28.0	3.62	G	G	6.0	1.02	-10°F	+130°F	Food and Beverage	82
3	Food Master® XTreme™ 250SD CR	250	30.0	3.86	S	P	18.0	2.46	-40°F	+230°F	Food and Beverage	70
3	Fuel Master™ 100SD	100	30.0	3.50	C	C2	6.0	1.71	-40°F	+180°F	Petroleum	141
3	Fuel Master™ 150D	150	—	3.45	C	A	—	1.37	-40°F	+180°F	Petroleum	140
3	Fuel Master™ 150SD	150	30.0	3.53	C	A	8.0	2.67	-40°F	+180°F	Petroleum	137
3	Fuel Master™ 150SD	150	30.0	3.53	C	A	9.0	2.40	-40°F	+180°F	Petroleum	137
3	Fuel Master™ 150SD LT MegaFlex®	150	30.0	3.44	C	A	3.0	1.13	-65°F	+180°F	Petroleum	139
3	Fuel Master™ 150SD MegaFlex®	150	30.0	3.44	C	A	3.0	1.45	-40°F	+180°F	Petroleum	138
3	Fuel Master™ PVC 65SD	65	28.0	3.76	C3	G	6.0	1.71	-30°F	+130°F	Petroleum	142
3	Fuel Master™ PVC Vapor Recovery 5SD	5	—	3.54	U	G	3.0	.69	-30°F	+140°F	Petroleum	144
3	Fuel Master™ XTreme™ 150SD	150	30.0	3.53	C	C2	9.0	1.86	-30°F	+180°F	Petroleum	135
3	Fuel Master™ XTreme™ 150SD MegaFlex®	150	30.0	3.44	C	C2	3.0	1.65	-30°F	+180°F	Petroleum	136
3	Green Stripe® Coolant and Air Hose	40	15.0	3.43	P	P	9.0	6.56	-40°F	+257°F	Marine and Engine	89
3	LP350	350	10.0	3.88	A	A	24.0	2.58	-40°F	+180°F	Petroleum	148
3	Marine Master™ Plus Wet Exhaust (15-100) SD	44	15.0	3.45	C	A	12.0	1.32	-40°F	+212°F	Marine and Engine	94
3	Marine Master™ Wet Exhaust 100D	100	—	3.36	P	P	—	14.45	-40°F	+257°F	Marine and Engine	92
3	Marine Master™ Wet Exhaust 100SD	100	15.0	3.54	P	P	9.0	1.55	-40°F	+257°F	Marine and Engine	93

AGRICULTURE

AIR BREATHING

AIR DUCT

AIR AND MULTI-PURPOSE

CHEMICAL

FOOD AND BEVERAGE

MARINE AND ENGINE

MATERIAL HANDLING

MINING

OILFIELD

PETROLEUM

PRESSURE WASH AND WASHDOWN

STEAM

WATER

CLAMPS

COUPLINGS AND FERRULES

HOSE FINDER

CHEMICAL RESISTANCE TABLE



## Hose Finder

	Hose I.D. (in)	Name	Rated W.P. (psi)	Vacuum (In. Hg.)	Hose O.D. (in)	Tube Type	Cover Type	MBR (in)	Wt. (lbs/ft)	Temp Min. (°F)	Temp Max. (°F)	Hose Categories	Catalog Page No.
AGRICULTURE													
AIR BREATHING													
AIR DUCT													
AIR AND MULTI-PURPOSE	3	MIL Low Pressure Fuel & Oil Hose	100	—	3.27	A	A	36.0	1.28	-40°F	+250°F	Marine and Engine	85
	3	Mine Master™ Air Drill 500	500	10.0	3.97	A	C2	36.0	4.10	-30°F	+212°F	Mining	109
	3	Mine Master™ Air Drill 500 FR	500	10.0	3.67	C	C2	36.0	2.77	-22°F	+180°F	Mining	110
	3	Mine Master™ Air Drill 600HT	600	—	3.64	J	J	18.0	2.62	-40°F	+300°F	Mining	108
CHEMICAL	3	Mine Master™ Air Drill 600HT	600	—	3.64	J	J	20.0	2.46	-40°F	+300°F	Mining	108
	3	Mine Master™ Longwall Emulsion 1000	1000	10.0	3.91	A	C2	20.0	4.14	-40°F	+212°F	Mining	107
FOOD AND BEVERAGE	3	Mine Master™ Rock Dust 100SD	100	30.0	3.41	D	C2	15.0	1.29	-40°F	+180°F	Mining	111
	3	Water Master® (100-150) SD	150	30.0	3.54	P	P	14.0	1.44	-32°F	+200°F	Water	161
MARINE AND ENGINE	3	Water Master® (100-150) SD AR	150	30.0	3.58	P	D	15.0	1.90	-40°F	+180°F	Water	160
	3	Water Master® (90-150) D	150	—	3.36	P	P	—	1.08	-40°F	+180°F	Water	165
	3	Water Master® 150D AR	150	—	3.33	P	D	36.0	1.21	-40°F	+180°F	Water	164
	3	Water Master® 150D AR	150	—	3.41	P	D	36.0	1.15	-40°F	+180°F	Water	164
MATERIAL HANDLING	3	Water Master® Plus PVC Layflat (100-150) D	125	—	3.29	G	G	—	.46	-10°F	+150°F	Water	168
	3	Water Master® PVC (40-100) SD	100	28.0	3.70	G1	G1	6.3	1.13	-13°F	+140°F	Water	166
MINING	3	Water Master® PVC Layflat (45-75) D	60	—	3.17	G	G	—	.39	+25°F	+120°F	Water	167
	3	Water Master® Slurry 150D AR	150	—	3.49	D	D	36.0	1.37	-40°F	+150°F	Water	163
OILFIELD	3	Water Master® Water Suction/Discharge 150SD	150	30.0	3.54	P	P	14.0	2.10	-40°F	+180°F	Water	162
	3 1/8	Air Duct (8-20) SD	10	7.0	3.38	A	A	10.0	.92	-30°F	+250°F	Air Duct	47
PETROLEUM	3 1/4	4169A Coolant Hose	35	—	3.64	C	A	—	1.30	-40°F	+212°F	Marine and Engine	88
	3 1/4	Engine Coolant Silicone	40	—	3.64	MQ	MQ	—	1.27	-65°F	+347°F	Marine and Engine	90
	3 1/2	4169A Coolant Hose	10	—	3.89	C	A	—	1.40	-40°F	+212°F	Marine and Engine	88
	3 1/2	4175EC Coolant Hose	18	—	3.89	P	P	—	1.18	-40°F	+257°F	Marine and Engine	86
	3 1/2	4176HD Coolant Hose	50	—	4.01	P	P	—	1.50	-40°F	+257°F	Marine and Engine	87
PRESSURE WASH AND WASHDOWN	3 1/2	Air Duct (5-10) SD	5	3.0	3.69	A	A	3.5	.57	-30°F	+250°F	Air Duct	46
	3 1/2	Air Duct (8-20) SD	10	7.0	3.75	A	A	10.0	1.01	-30°F	+250°F	Air Duct	47
	3 1/2	Bulk Master™ Hot Air Blower (40-130) SD HT	85	30.0	4.14	P	P	21.0	1.95	-40°F	+350°F	Material Handling	102
	3 1/2	Engine Coolant Silicone	35	—	3.89	MQ	MQ	—	1.36	-65°F	+347°F	Marine and Engine	90
STEAM	3 1/2	Green Stripe® Coolant and Air Hose	35	15.0	3.93	P	P	12.0	7.56	-40°F	+257°F	Marine and Engine	89
WATER	3 1/2	Marine Master™ Plus Wet Exhaust (15-100) SD	35	15.0	3.95	C	A	17.0	1.37	-40°F	+212°F	Marine and Engine	94
	3 1/2	Marine Master™ Wet Exhaust 100D	100	—	3.86	P	P	—	16.63	-40°F	+257°F	Marine and Engine	92
CLAMPS	3 1/2	Marine Master™ Wet Exhaust 100SD	100	15.0	4.04	P	P	9.0	1.78	-40°F	+257°F	Marine and Engine	93
	3 1/2	MIL Low Pressure Fuel & Oil Hose	90	—	3.81	A	A	42.0	1.82	-40°F	+250°F	Marine and Engine	85
COUPLINGS AND FERRULES	3 1/2	Water Master® 150D AR	150	—	3.91	P	D	42.0	1.30	-40°F	+180°F	Water	164
	3 1/2	Water Master® Slurry 150D AR	150	—	3.99	D	D	42.0	1.60	-40°F	+150°F	Water	163
	3 5/8	Air Duct (5-10) SD	5	3.0	3.81	A	A	4.0	.59	-30°F	+250°F	Air Duct	46
HOSE FINDER	3 3/4	Engine Coolant Silicone	35	—	4.14	MQ	MQ	—	1.44	-65°F	+347°F	Marine and Engine	90
	4	4169A Coolant Hose	10	—	4.39	C	A	—	1.69	-40°F	+212°F	Marine and Engine	88
	4	4175EC Coolant Hose	12	—	4.39	P	P	—	1.34	-40°F	+257°F	Marine and Engine	86
	4	4176HD Coolant Hose	38	—	4.51	P	P	—	1.69	-40°F	+257°F	Marine and Engine	87
CHEMICAL RESISTANCE TABLE	4	Ag Master™ PVC Solution (30-90) SD Clear	35	28.0	4.65	G	—	8.0	1.65	-10°F	+130°F	Agriculture	42
	4	Ag Master™ PVC Solution (30-90) SD Clear	50	28.0	4.52	G	—	13.0	1.94	-10°F	+130°F	Agriculture	42

## Hose Finder

Hose I.D. (in)	Name	Rated W.P. (psi)	Vacuum (In. Hg.)	Hose O.D. (in)	Tube Type	Cover Type	MBR (in)	Wt. (lbs/ft)	Temp Min. (°F)	Temp Max. (°F)	Hose Categories	Catalog Page No.
4	Ag Master™ PVC Solution (35-80) SD	45	28.0	4.69	P	G	17.0	1.80	-30°F	+140°F	Agriculture	41
4	Ag Master™ Solution 150SD	150	30.0	4.54	P	P	18.0	2.55	-40°F	+180°F	Agriculture	39
4	Air Duct (5-10) SD	5	3.0	4.19	A	A	4.0	1.02	-30°F	+250°F	Air Duct	46
4	Air Duct (8-20) SD	10	7.0	4.25	A	A	12.0	1.15	-30°F	+250°F	Air Duct	47
4	Black Gold® ABS Bulk Material (250-300) D	300	10.0	4.96	D3	D	28.0	3.40	-40°F	+150°F	Oilfield	120
4	Black Gold® ABS Bulk Material 300SD	300	29.0	5.30	D3	D	42.0	4.71	-40°F	+150°F	Oilfield	119
4	Black Gold® ABS Chemical Plus XLPE 250SD	250	30.1	4.70	K	P	24.0	3.05	-40°F	+250°F	Oilfield	112
4	Black Gold® ABS Drill Water 300D	300	10.0	4.64	P	P	28.0	1.94	-40°F	+150°F	Oilfield	114
4	Black Gold® ABS Drill Water 300SD	300	30.0	4.62	P	P	30.0	3.18	-40°F	+150°F	Oilfield	113
4	Black Gold® ABS Mud and Oil 300D	300	10.0	4.62	C	A	28.0	2.39	-40°F	+180°F	Oilfield	126
4	Black Gold® ABS Mud and Oil 300SD	300	30.0	5.10	C	A	42.0	4.48	-40°F	+180°F	Oilfield	125
4	Black Gold® ABS Potable Water 300D	300	—	4.69	D2	P	—	1.75	-40°F	+150°F	Oilfield	117
4	Black Gold® ABS Potable Water 300SD	300	29.0	4.96	D2	P	28.0	3.68	-40°F	+150°F	Oilfield	116
4	Black Gold® Blender Transfer 150D	150	—	4.73	C	A	—	3.07	-40°F	+180°F	Oilfield	121
4	Black Gold® Fuel 300D	300	10.0	4.70	C	A	28.0	3.14	-40°F	+180°F	Oilfield	128
4	Black Gold® Fuel 300SD	300	30.0	4.87	C	A	24.0	3.52	-40°F	+180°F	Oilfield	127
4	Black Gold® Oilfield Frac 400D	400	10.0	4.78	C	D	30.0	2.81	-40°F	+180°F	Oilfield	134
4	Black Gold® Oilfield Frac 400SD	400	30.0	4.78	C	D	38.0	3.92	-40°F	+180°F	Oilfield	133
4	Black Gold® Oilfield Service 400D	400	10.0	4.83	C	A	30.0	3.43	-40°F	+180°F	Oilfield	131
4	Black Gold® Oilfield Service 400D	400	10.0	4.84	C	A	30.0	3.10	-40°F	+180°F	Oilfield	131
4	Black Gold® Oilfield Service 400D UltraBration®	400	10.0	4.81	C	C4	30.0	3.13	-40°F	+180°F	Oilfield	129
4	Black Gold® Oilfield Service 400SD	400	30.0	4.99	C	A	25.0	4.64	-40°F	+180°F	Oilfield	130
4	Black Gold® Oilfield Vacuum (100-150) SD	100	30.0	4.52	C	D	8.0	2.14	-40°F	+150°F	Oilfield	123
4	Black Gold® Potable Water (150-300) D	150	10.0	4.70	D2	P	28.0	2.74	-40°F	+150°F	Oilfield	118
4	Black Gold® Slim Hole Rotary (1500-5000)	1500	—	5.06	C	A	48.0	7.22	-40°F	+180°F	Oilfield	115
4	Black Gold® Super-Vac® (60-150) SD	100	30.0	4.52	C	D	8.0	2.29	-40°F	+180°F	Oilfield	122
4	Black Gold® Super-Vac® MegaFlex® (100-200) SD	100	30.0	4.52	C	D	4.0	2.29	-40°F	+180°F	Oilfield	124
4	Black Gold® Super-Vac® MegaFlex® (100-200) SD	200	30.0	4.52	C	D	4.0	2.12	-40°F	+180°F	Oilfield	124
4	Bulk Master™ (4-24) SD	16	20.0	4.39	D3	D	15.0	1.35	-40°F	+150°F	Material Handling	103
4	Bulk Master™ Dry Cement (20-75) D	60	—	4.61	D3	D	48.0	2.11	-40°F	+150°F	Material Handling	100
4	Bulk Master™ Dry Cement (20-75) D	60	—	4.73	D3	D	48.0	2.71	-40°F	+150°F	Material Handling	100
4	Bulk Master™ Dry Cement (20-75) D	75	—	4.47	D3	D	48.0	1.69	-40°F	+150°F	Material Handling	100
4	Bulk Master™ Hot Air Blower (40-130) SD HT	75	30.0	4.64	P	P	24.0	2.21	-40°F	+350°F	Material Handling	102
4	Bulk Master™ Plus (35-60) SD	45	30.0	4.77	D3	D	32.0	3.37	-40°F	+150°F	Material Handling	101
4	Bulk Master™ PVC (25-40) SD AR	30	28.0	4.65	C	G	8.0	1.70	-30°F	+140°F	Material Handling	105

AGRICULTURE

AIR BREATHING

AIR DUCT

AIR AND MULTI-PURPOSE

CHEMICAL

FOOD AND BEVERAGE

MARINE AND ENGINE

MATERIAL HANDLING

MINING

OILFIELD

PETROLEUM

PRESSURE WASH AND WASHDOWN

STEAM

WATER

CLAMPS

COUPLINGS AND FERRULES

HOSE FINDER

CHEMICAL RESISTANCE TABLE

## Hose Finder

AGRICULTURE	AIR BREATHING	AIR DUCT	AIR AND MULTI-PURPOSE	CHEMICAL	FOOD AND BEVERAGE	MARINE AND ENGINE	MATERIAL HANDLING	MINING	OILFIELD	PETROLEUM	PRESSURE WASH AND WASHDOWN	STEAM	WATER	CLAMPS	COUPLINGS AND FERRULES	HOSE FINDER	CHEMICAL RESISTANCE TABLE	
Hose I.D. (in)	Name	Rated W.P. (psi)	Vacuum (In. Hg.)	Hose O.D. (in)	Tube Type	Cover Type	MBR (in)	Wt. (lbs/ft)	Temp Min. (°F)	Temp Max. (°F)	Hose Categories	Catalog Page No.						
4	Chem Master™ EPDM (125-150) SD	150	30.0	4.60	P	P	16.0	2.25	-40°F	+250°F	Chemical	66						
4	Chem Master™ Plus CPE (150-200) SD MegaFlex®	150	30.0	4.49	J	P	10.0	2.08	-40°F	+275°F	Chemical	65						
4	Chem Master™ Plus UHMWPE (125-200) SD	125	30.0	4.53	L	P	24.0	2.49	-40°F	+212°F	Chemical	64						
4	Chem Master™ Plus XLPE (150-200) SD	150	30.0	4.69	K	P	24.0	2.72	-40°F	+250°F	Chemical	62						
4	Chem Master™ XTreme™ FEP (125-200) SD	125	30.0	4.66	T	P	24.0	2.60	-40°F	+300°F	Chemical	60						
4	Engine Coolant Silicone	35	—	4.39	MQ	MQ	—	1.54	-65°F	+347°F	Marine and Engine	90						
4	Food Master® Beverage 150SD CR	150	30.0	4.76	S	P	28.0	3.16	-40°F	+212°F	Food and Beverage	72						
4	Food Master® Beverage 250SD CR	250	30.0	4.88	S	P	36.0	2.75	-40°F	+230°F	Food and Beverage	71						
4	Food Master® Dry Goods (25-40) D	40	—	4.56	D2	C4	48.0	2.08	-40°F	+150°F	Food and Beverage	77						
4	Food Master® Dry Goods (50-150) SD	75	30.0	4.71	D2	P	24.0	3.00	-40°F	+150°F	Food and Beverage	76						
4	Food Master® Oils and Dairy 150D	150	—	4.60	C2	C2	48.0	2.78	-40°F	+230°F	Food and Beverage	74						
4	Food Master® Oils and Dairy 150SD	150	30.0	4.60	C2	C2	18.0	3.13	-40°F	+230°F	Food and Beverage	73						
4	Food Master® Oils and Dairy 150SD	150	30.0	4.60	C2	C2	24.0	3.12	-40°F	+230°F	Food and Beverage	73						
4	Food Master® Oils and Dairy 150SD MegaFlex®	150	30.0	4.73	C2	C2	12.0	3.07	-40°F	+230°F	Food and Beverage	75						
4	Food Master® PVC (35-50) SD Clear	35	28.0	4.65	G	G	8.0	1.65	-10°F	+130°F	Food and Beverage	81						
4	Food Master® PVC (50-100) SD Clear	50	28.0	4.56	G	G	12.0	2.00	-10°F	+130°F	Food and Beverage	80						
4	Food Master® PVC Dry Goods (35-40) SD Clear	35	28.0	4.54	G	G	8.0	1.36	-10°F	+130°F	Food and Beverage	82						
4	Food Master® XTreme™ 250SD CR	250	30.0	4.88	S	P	36.0	3.24	-40°F	+230°F	Food and Beverage	70						
4	Fuel Master™ 100SD	100	30.0	4.50	C	C2	11.0	2.38	-40°F	+180°F	Petroleum	141						
4	Fuel Master™ 150D	150	—	4.51	C	A	—	2.03	-40°F	+180°F	Petroleum	140						
4	Fuel Master™ 150SD	150	30.0	4.57	C	A	12.0	3.29	-40°F	+180°F	Petroleum	137						
4	Fuel Master™ 150SD	150	30.0	4.64	C	A	11.0	3.14	-40°F	+180°F	Petroleum	137						
4	Fuel Master™ 150SD LT MegaFlex®	150	30.0	4.49	C	A	4.0	1.13	-65°F	+180°F	Petroleum	139						
4	Fuel Master™ 150SD MegaFlex®	150	30.0	4.48	C	A	4.0	2.15	-40°F	+180°F	Petroleum	138						
4	Fuel Master™ PVC 65SD	65	28.0	4.79	C3	G	8.0	2.44	-30°F	+130°F	Petroleum	142						
4	Fuel Master™ PVC Vapor Recovery 5SD	5	—	4.56	U	G	4.0	.92	-30°F	+140°F	Petroleum	144						
4	Fuel Master™ XTreme™ 150SD	150	30.0	4.57	C	C2	12.0	2.59	-30°F	+180°F	Petroleum	135						
4	Fuel Master™ XTreme™ 150SD MegaFlex®	150	30.0	4.48	C	C2	4.0	1.20	-30°F	+180°F	Petroleum	136						
4	Green Stripe® Coolant and Air Hose	30	10.0	4.43	P	P	20.0	8.57	-40°F	+257°F	Marine and Engine	89						
4	Marine Master™ Plus Wet Exhaust (15-100) SD	30	10.0	4.46	C	A	24.0	1.65	-40°F	+212°F	Marine and Engine	94						
4	Marine Master™ Wet Exhaust 100D	100	—	4.36	P	P	—	18.57	-40°F	+257°F	Marine and Engine	92						
4	Marine Master™ Wet Exhaust 100SD	100	10.0	4.54	P	P	12.0	27.54	-40°F	+257°F	Marine and Engine	93						
4	MIL Low Pressure Fuel & Oil Hose	75	—	4.30	A	A	48.0	1.78	-40°F	+250°F	Marine and Engine	85						
4	Mine Master™ Air Drill 500	500	10.0	5.06	A	C2	47.6	5.32	-30°F	+212°F	Mining	109						
4	Mine Master™ Air Drill 600HT	600	—	4.79	J	J	25.0	4.10	-40°F	+300°F	Mining	108						

## Hose Finder

Hose I.D. (in)	Name	Rated W.P. (psi)	Vacuum (In. Hg.)	Hose O.D. (in)	Tube Type	Cover Type	MBR (in)	Wt. (lbs/ft)	Temp Min. (°F)	Temp Max. (°F)	Hose Categories	Catalog Page No.
4	Water Master® (100-150) SD	150	30.0	4.54	P	P	16.0	4.36	-32°F	+200°F	Water	161
4	Water Master® (100-150) SD	150	30.0	4.54	P	P	18.0	2.25	-32°F	+200°F	Water	161
4	Water Master® (100-150) SD AR	150	30.0	4.58	P	D	20.0	2.48	-40°F	+180°F	Water	160
4	Water Master® (90-150) D	150	—	4.36	P	P	—	1.41	-40°F	+180°F	Water	165
4	Water Master® 150D AR	150	—	4.33	P	D	48.0	1.50	-40°F	+180°F	Water	164
4	Water Master® 150D AR	150	—	4.41	P	D	48.0	1.55	-40°F	+180°F	Water	164
4	Water Master® Plus PVC Layflat (100-150) D	100	—	4.32	G	G	—	.73	-10°F	+150°F	Water	168
4	Water Master® PVC (40-100) SD	75	28.0	4.78	G1	G1	7.1	1.74	-13°F	+140°F	Water	166
4	Water Master® PVC Layflat (45-75) D	60	—	4.20	G	G	—	.53	+25°F	+120°F	Water	167
4	Water Master® Slurry 150D AR	150	—	4.49	D	D	48.0	1.85	-40°F	+150°F	Water	163
4	Water Master® Water Suction/Discharge 150SD	150	30.0	4.54	P	P	18.0	2.37	-40°F	+180°F	Water	162
4 1/2	4169A Coolant Hose	10	—	4.89	C	A	—	1.90	-40°F	+212°F	Marine and Engine	88
4 1/2	4175EC Coolant Hose	12	—	4.89	P	P	—	1.52	-40°F	+257°F	Marine and Engine	86
4 1/2	Air Duct (5-10) SD	5	3.0	4.69	A	A	5.0	1.02	-30°F	+250°F	Air Duct	46
4 1/2	Air Duct (8-20) SD	10	7.0	4.75	A	A	12.0	1.25	-30°F	+250°F	Air Duct	47
4 1/2	Bulk Master™ Dry Cement (20-75) D	35	—	4.97	D3	D	54.0	1.92	-40°F	+150°F	Material Handling	100
4 1/2	Bulk Master™ Plus (35-60) SD	40	30.0	5.27	D3	D	36.0	3.70	-40°F	+150°F	Material Handling	101
4 1/2	Engine Coolant Silicone	25	—	4.89	MQ	MQ	—	1.73	-65°F	+347°F	Marine and Engine	90
4 1/2	Marine Master™ Plus Wet Exhaust (15-100) SD	25	5.0	4.96	C	A	27.0	1.76	-40°F	+212°F	Marine and Engine	94
4 1/2	Marine Master™ Wet Exhaust 100D	100	—	4.86	P	P	—	21.00	-40°F	+257°F	Marine and Engine	92
4 1/2	Marine Master™ Wet Exhaust 100SD	100	10.0	5.04	P	P	12.0	30.79	-40°F	+257°F	Marine and Engine	93
4 1/2	Water Master® Slurry 150D AR	150	—	5.01	D	D	54.0	2.16	-40°F	+150°F	Water	163
5	Ag Master™ PVC Solution (30-90) SD Clear	30	28.0	5.73	G	—	11.0	2.34	-10°F	+130°F	Agriculture	42
5	Ag Master™ PVC Solution (30-90) SD Clear	45	28.0	5.65	G	—	21.0	3.09	-10°F	+130°F	Agriculture	42
5	Air Duct (5-10) SD	5	3.0	5.19	A	A	6.0	1.09	-30°F	+250°F	Air Duct	46
5	Air Duct (8-20) SD	10	6.0	5.25	A	A	12.0	1.40	-30°F	+250°F	Air Duct	47
5	Black Gold® ABS Bulk Material (250-300) D	300	10.0	6.14	D3	D	35.0	4.67	-40°F	+150°F	Oilfield	120
5	Black Gold® ABS Bulk Material 300SD	300	29.0	6.33	D3	D	51.0	6.02	-40°F	+150°F	Oilfield	119
5	Black Gold® ABS Drill Water 300D	300	10.0	5.78	P	P	48.0	2.85	-40°F	+150°F	Oilfield	114
5	Black Gold® ABS Drill Water 300SD	300	30.0	5.92	P	P	48.0	5.05	-40°F	+150°F	Oilfield	113
5	Black Gold® ABS Mud and Oil 300D	300	10.0	5.92	C	A	35.0	4.40	-40°F	+180°F	Oilfield	126
5	Black Gold® ABS Mud and Oil 300SD	300	30.0	6.20	C	A	51.0	6.00	-40°F	+180°F	Oilfield	125
5	Black Gold® ABS Potable Water 300SD	300	29.0	6.09	D2	P	36.0	5.05	-40°F	+150°F	Oilfield	116
5	Black Gold® Blender Transfer 150D	150	—	5.73	C	A	—	3.77	-40°F	+180°F	Oilfield	121
5	Black Gold® Fuel 300D	300	10.0	6.84	C	A	35.0	4.50	-40°F	+180°F	Oilfield	128
5	Bulk Master™ (4-24) SD	20	20.0	5.53	D3	D	20.0	2.27	-40°F	+150°F	Material Handling	103
5	Bulk Master™ Dry Cement (20-75) D	75	—	5.47	D3	D	60.0	2.12	-40°F	+150°F	Material Handling	100
5	Bulk Master™ Hot Air Blower (40-130) SD HT	55	30.0	5.74	P	P	30.0	3.13	-40°F	+350°F	Material Handling	102

AGRICULTURE

AIR BREATHING

AIR DUCT

AIR AND MULTI-PURPOSE

CHEMICAL

FOOD AND BEVERAGE

MARINE AND ENGINE

MATERIAL HANDLING

MINING

OILFIELD

PETROLEUM

PRESSURE WASH AND WASHDOWN

STEAM

WATER

CLAMPS

COUPLINGS AND FERRULES

HOSE FINDER

CHEMICAL RESISTANCE TABLE

## Hose Finder

AGRICULTURE	AIR BREATHING	AIR DUCT	AIR AND MULTI-PURPOSE	CHEMICAL	FOOD AND BEVERAGE	MARINE AND ENGINE	MATERIAL HANDLING	MINING	OILFIELD	PETROLEUM	PRESSURE WASH AND WASHDOWN	STEAM	WATER	CLAMPS	COUPLINGS AND FERRULES	HOSE FINDER	CHEMICAL RESISTANCE TABLE	
Hose I.D. (in)	Name	Rated W.P. (psi)	Vacuum (In. Hg.)	Hose O.D. (in)	Tube Type	Cover Type	MBR (in)	Wt. (lbs/ft)	Temp Min. (°F)	Temp Max. (°F)	Hose Categories	Catalog Page No.						
5	Bulk Master™ Plus (35-60) SD	40	30.0	5.77	D3	D	40.0	4.14	-40°F	+150°F	Material Handling	101						
5	Bulk Master™ PVC (25-40) SD AR	30	28.0	5.77	C	G	9.0	2.40	-30°F	+140°F	Material Handling	105						
5	Food Master® Dry Goods (25-40) D	30	—	5.56	D2	C4	60.0	2.46	-40°F	+150°F	Food and Beverage	77						
5	Food Master® Dry Goods (50-150) SD	55	30.0	5.75	D2	P	30.0	3.98	-40°F	+150°F	Food and Beverage	76						
5	Fuel Master™ PVC Vapor Recovery 5SD	5	—	5.51	U	G	5.0	1.13	-30°F	+140°F	Petroleum	144						
5	Green Stripe® Coolant and Air Hose	15	5.0	5.43	P	P	24.0	13.45	-40°F	+257°F	Marine and Engine	89						
5	Marine Master™ Plus Wet Exhaust (15-100) SD	20	5.0	5.46	C	A	30.0	2.02	-40°F	+212°F	Marine and Engine	94						
5	Marine Master™ Wet Exhaust 100D	100	—	5.37	P	P	—	23.35	-40°F	+257°F	Marine and Engine	92						
5	Marine Master™ Wet Exhaust 100SD	100	5.0	5.54	P	P	20.0	33.93	-40°F	+257°F	Marine and Engine	93						
5	Water Master® (100-150) SD AR	100	30.0	5.60	P	D	25.0	3.62	-40°F	+180°F	Water	160						
5	Water Master® 150D AR	150	—	5.44	P	D	60.0	2.17	-40°F	+180°F	Water	164						
5	Water Master® PVC (40-100) SD	70	28.0	6.04	G1	G1	9.2	2.90	-13°F	+140°F	Water	166						
5 1/2	Air Duct (5-10) SD	5	3.0	5.69	A	A	6.0	1.49	-30°F	+250°F	Air Duct	46						
5 1/2	Air Duct (8-20) SD	10	6.0	5.75	A	A	12.0	1.52	-30°F	+250°F	Air Duct	47						
5 1/2	Marine Master™ Wet Exhaust 100SD	100	5.0	6.04	P	P	22.0	39.14	-40°F	+257°F	Marine and Engine	93						
6	Ag Master™ PVC Solution (30-90) SD Clear	35	28.0	6.98	G	—	15.0	4.08	-10°F	+130°F	Agriculture	42						
6	Ag Master™ PVC Solution (30-90) SD Clear	45	28.0	6.80	G	—	24.0	4.56	-10°F	+130°F	Agriculture	42						
6	Ag Master™ PVC Solution (35-80) SD	35	28.0	6.86	P	G	27.0	3.10	-30°F	+140°F	Agriculture	41						
6	Air Duct (8-20) SD	8	6.0	6.25	A	A	15.0	1.70	-30°F	+250°F	Air Duct	47						
6	Black Gold® ABS Bulk Material (250-300) D	250	10.0	7.13	D3	D	42.0	5.51	-40°F	+150°F	Oilfield	120						
6	Black Gold® ABS Bulk Material 300SD	300	29.0	7.33	D3	D	60.0	6.02	-40°F	+150°F	Oilfield	119						
6	Black Gold® ABS Drill Water 300D	300	10.0	6.82	P	P	60.0	2.85	-40°F	+150°F	Oilfield	114						
6	Black Gold® ABS Drill Water 300SD	300	30.0	6.92	P	P	60.0	7.53	-40°F	+150°F	Oilfield	113						
6	Black Gold® ABS Mud and Oil 300D	300	10.0	6.92	C	A	42.0	5.25	-40°F	+180°F	Oilfield	126						
6	Black Gold® ABS Mud and Oil 300SD	300	30.0	7.40	C	A	60.0	8.59	-40°F	+180°F	Oilfield	125						
6	Black Gold® ABS Potable Water 300SD	300	29.0	7.16	D2	P	40.0	6.69	-40°F	+150°F	Oilfield	116						
6	Black Gold® Fuel 300D	300	10.0	6.84	C	A	46.0	4.91	-40°F	+180°F	Oilfield	128						
6	Black Gold® Fuel 300SD	300	30.0	7.07	C	A	36.0	5.00	-40°F	+180°F	Oilfield	127						
6	Black Gold® Super-Vac® (60-150) SD	60	30.0	6.67	C	D	18.0	4.29	-40°F	+180°F	Oilfield	122						
6	Bulk Master™ (4-24) SD	24	20.0	6.53	D3	D	24.0	3.20	-40°F	+150°F	Material Handling	103						
6	Bulk Master™ Dry Cement (20-75) D	25	—	6.47	D3	D	72.0	2.51	-40°F	+150°F	Material Handling	100						
6	Bulk Master™ Hot Air Blower (40-130) SD HT	40	30.0	6.74	P	P	36.0	4.54	-40°F	+350°F	Material Handling	102						
6	Bulk Master™ Plus (35-60) SD	40	30.0	6.76	D3	D	48.0	5.07	-40°F	+150°F	Material Handling	101						
6	Bulk Master™ PVC (25-40) SD AR	25	28.0	6.86	C	G	12.0	3.21	-30°F	+140°F	Material Handling	105						
6	Chem Master™ EPDM (125-150) SD	125	30.0	6.78	P	P	24.0	5.29	-40°F	+250°F	Chemical	66						

## Hose Finder

Hose I.D. (in)	Name	Rated W.P. (psi)	Vacuum (In. Hg.)	Hose O.D. (in)	Tube Type	Cover Type	MBR (in)	Wt. (lbs/ft)	Temp Min. (°F)	Temp Max. (°F)	Hose Categories	Catalog Page No.
6	Food Master® Dry Goods (25-40) D	25	—	6.56	D2	C4	72.0	3.04	-40°F	+150°F	Food and Beverage	77
6	Food Master® Dry Goods (50-150) SD	50	30.0	6.91	D2	P	36.0	5.88	-40°F	+150°F	Food and Beverage	76
6	Food Master® Oils and Dairy 150D	150	—	6.60	C2	C2	72.0	4.10	-40°F	+230°F	Food and Beverage	74
6	Food Master® Oils and Dairy 150SD	150	30.0	6.69	C2	C2	36.0	5.59	-40°F	+230°F	Food and Beverage	73
6	Fuel Master™ 150SD	150	30.0	6.79	C	A	17.0	5.46	-40°F	+180°F	Petroleum	137
6	Fuel Master™ 150SD MegaFlex®	150	30.0	6.55	C	A	6.0	4.15	-40°F	+180°F	Petroleum	138
6	Fuel Master™ PVC Vapor Recovery 5SD	5	—	6.52	U	G	6.0	1.24	-30°F	+140°F	Petroleum	144
6	Green Stripe® Coolant and Air Hose	15	5.0	6.43	P	P	30.0	15.00	-40°F	+257°F	Marine and Engine	89
6	Marine Master™ Plus Wet Exhaust (15-100) SD	15	5.0	6.46	C	A	36.0	2.40	-40°F	+212°F	Marine and Engine	94
6	Marine Master™ Wet Exhaust 100D	100	—	6.38	P	P	—	27.14	-40°F	+257°F	Marine and Engine	92
6	Marine Master™ Wet Exhaust 100SD	100	5.0	6.68	P	P	24.0	40.22	-40°F	+257°F	Marine and Engine	93
6	Water Master® (100-150) SD	100	30.0	6.68	P	P	26.0	2.55	-32°F	+200°F	Water	161
6	Water Master® (100-150) SD	100	30.0	6.68	P	P	28.0	3.94	-32°F	+200°F	Water	161
6	Water Master® (100-150) SD AR	100	30.0	6.65	P	D	30.0	4.84	-40°F	+180°F	Water	160
6	Water Master® (90-150) D	125	—	6.38	P	P	—	2.09	-40°F	+180°F	Water	165
6	Water Master® 150D AR	150	—	6.40	P	D	72.0	2.60	-40°F	+180°F	Water	164
6	Water Master® 150D AR	150	—	6.49	P	D	72.0	2.92	-40°F	+180°F	Water	164
6	Water Master® Plus PVC Layflat (100-150) D	100	—	6.40	G	G	—	1.18	-10°F	+150°F	Water	168
6	Water Master® PVC (40-100) SD	70	28.0	7.17	G1	G1	10.2	3.88	-13°F	+140°F	Water	166
6	Water Master® PVC Layflat (45-75) D	45	—	6.20	G	G	—	.88	+25°F	+120°F	Water	167
6	Water Master® Slurry 150D AR	150	—	6.51	D	D	72.0	2.84	-40°F	+150°F	Water	163
6 5/8	Bulk Master™ Dry Cement (20-75) D	20	—	7.10	D3	D	72.0	2.35	-40°F	+150°F	Material Handling	100
6 5/8	Bulk Master™ Plus (35-60) SD	35	30.0	7.47	D3	D	36.0	5.36	-40°F	+150°F	Material Handling	101
6 5/8	Water Master® (90-150) D	90	—	7.12	P	P	—	3.08	-40°F	+180°F	Water	165
8	Black Gold® Oilfield Service (100-150) SD	100	30.0	8.74	C	D	24.0	117.00	-40°F	+180°F	Oilfield	132
8	Black Gold® Oilfield Service (100-150) SD	150	30.0	9.00	C	D	24.0	165.73	-40°F	+180°F	Oilfield	132
8	Bulk Master™ PVC (25-40) SD AR	25	28.0	9.10	C	G	16.0	5.77	-30°F	+140°F	Material Handling	105
8	Water Master® (100-150) SD	100	30.0	9.00	P	P	40.0	8.68	-32°F	+200°F	Water	161
8	Water Master® PVC (40-100) SD	60	28.0	9.34	G1	G1	15.7	5.54	-13°F	+140°F	Water	166
8	Water Master® PVC Layflat (45-75) D	45	—	8.16	G	G	—	1.27	+25°F	+120°F	Water	167
10	Water Master® (100-150) SD	100	30.0	11.27	P	P	50.0	15.80	-32°F	+200°F	Water	161
12	Water Master® (100-150) SD	100	30.0	13.27	P	P	60.0	17.60	-32°F	+200°F	Water	161

AGRICULTURE

AIR BREATHING

AIR DUCT

AIR AND MULTI-PURPOSE

CHEMICAL

FOOD AND BEVERAGE

MARINE AND ENGINE

MATERIAL HANDLING

MINING

OILFIELD

PETROLEUM

PRESSURE WASH AND WASHDOWN

STEAM

WATER

CLAMPS

COUPLINGS AND FERRULES

HOSE FINDER

CHEMICAL RESISTANCE TABLE

# CHEMICAL RESISTANCE TABLE

AGRICULTURE
AIR BREATHING
AIR DUCT
AIR AND MULTI-PURPOSE
CHEMICAL
FOOD AND BEVERAGE
MARINE AND ENGINE
MATERIAL HANDLING
MINING
OILFIELD
PETROLEUM
PRESSURE WASH AND WASHDOWN
STEAM
WATER
CLAMPS
COUPLINGS AND FERRULES
HOSE FINDER
CHEMICAL RESISTANCE TABLE

The Chemical Resistance Table was compiled for use as a guide in selecting the most satisfactory hose tube and cover stocks for specific chemical applications. The data included are the best available to us at this time and will be revised as additional test information is obtained. It is always advisable to test rubber stocks under actual application conditions whenever possible.

We recognize that much of the material contained in this resistance table must be, to a degree, general in nature. Factors such as method of compounding, temperature, chemical concentrations, conditions of exposure, etc., can appreciably affect polymer behavior.

For certain applications, hoses designed for these applications must be used; therefore, the choice of tube stocks is restricted. These applications are:

**Steam** — Hose from the Steam Hose line

**Edible Products** — FDA, 3A, USDA

**Concentrated Chemicals** — Hose from the Acid-Chemical Hose line

**L.P. Gas** — LP Gas Hose only

**Gasoline and Petroleum Products** — Hoses from the Petroleum Transfer Hose line

**Hydraulic** — Hoses from Hydraulic Products Catalog

The nature of certain chemicals is such that Gates cannot offer a suitable hose to handle them.

Many of the common chemicals are included in the Chemical Resistance Table. If they are not listed, please contact Hose/Connectors Product Application, Denver.

**NOTE:** Before using a Gates hose to convey a chemical not listed in this Chemical Resistance Table, contact Denver Product Application for a recommendation. Phone (303) 744-5070. Email: fppasupport@gates.com

## Hose Selection Procedure:

- |   |   |
|---|---|
| <p>1. Identify the...</p> <p><b>Size</b> of Hose required.</p> <p><b>Temperature</b> of material being conveyed and environmental temperature.</p> <p><b>Application</b> conditions/requirements such as vibration, flexing, abrasion.</p> <p><b>Material</b> being conveyed.</p> <p><b>Pressure</b> of operation and maximum obtainable in the system including "spikes" and pump/valve ratings.</p> <p><b>End Requirements</b>, what type of terminations.</p> <p><b>Delivery</b> of the product.</p> | <p>2. Locate the material being conveyed in the chemical resistance chart and identify potential tube materials. For intermittent contact or transfer service, make note of all tube materials with a <b>1</b> or <b>2</b> rating. For continuous contact applications make note of tube materials with a 1 rating only.</p> <p>3. Use the Industrial Hose Catalog, Industrial Hose Finder, or Hydraulic Hose Catalog to select hoses that have satisfactory working pressure ratings.</p> <p>4. Verify maximum and minimum operating temperatures.</p> <p>5. Select the hose that has the best chemical resistance rating (i.e. 1 is Preferred, 2 is Acceptable).</p> <p>6. Select the proper coupling for the hose chosen from the Industrial Hose Catalog.</p> |
|---|---|

**NOTE:** For Gates Acid/Chemical Hose, permanent-style couplings must be used for service temperatures above 125°F (52°C).

# LISTING OF GATES HOSE STOCK TYPES

Stock Type	Composition
A	Polychloroprene (Chloroprene)
A2	Similar to Type A except it is white and is used primarily for edible products
B1 B2	Proprietary for special applications. Contact Denver Hose Product Application
C	Acrylonitrile Butadiene (Nitrile)
C2	A blend of Type C and plastic (Modified Nitrile). Used primarily as hose cover material
C3	Modified Nitrile
C4	Modification of Nitrile with excellent abrasion resistance (Carboxylated Nitrile)
D	Natural Rubber (NR) and Styrene Butadiene (SBR)
D2	Similar to Type D, except it is white and compounded to handle food products
D3	Natural Rubber
G	PolyVinyl Chloride (PVC)
G1	Modified PVC
H	Isobutylene and Isoprene (Butyl)
J	Chlorinated Polyethylene (CPE)
K	Specially compounded Cross-Linked Polyethylene (Gatron™)
L	Ultra High Molecular Weight PolyEthylene (UHMWPE)
M	Chlorosulfonated Polyethylene (CSM)
MQ	Silicone Rubber
P	Ethylene Propylene Diene (EPDM)
P2	Special for Steam Hose applications
S	Specially Compounded Thermoplastic Vulcanizate (Sanitron™)
T	Fluorinated Polyethylene (FEP)
U	Urethane
V	Fluorocarbon (FKM)
Z	Polyamide Resins (Nylon)

**NOTE:** Tube and cover compounds with the same name or Gates Type can differ between hoses. Compounds are designed for specific hose application requirements. Refer to the hose product sheet for recommended applications and restrictions. Example: Petroleum Transfer Hose Fuel Master 150SD (Type C Nitrile) has a different Nitrile tube compound than Marine Master Fuel Line (Type C Nitrile). Please read and observe all warnings on the back of the front cover of this catalog.

AGRICULTURE

AIR BREATHING

AIR DUCT

AIR AND MULTI-PURPOSE

CHEMICAL

FOOD AND BEVERAGE

MARINE AND ENGINE

MATERIAL HANDLING

MINING

OILFIELD

PETROLEUM

PRESSURE WASH AND WASHDOWN

STEAM

WATER

CLAMPS

COUPLINGS AND FERRULES

HOSE FINDER

CHEMICAL RESISTANCE TABLE



## Chemical Resistance Table

CHEMICAL RESISTANCE TABLE	HOSE FINDER	COUPLINGS AND FERRULES	CLAMPS	WATER	STEAM	PRESSURE WASH AND WASHDOWN	PETROLEUM	OILFIELD	MINING	MATERIAL HANDLING	MARINE AND ENGINE	FOOD AND BEVERAGE	CHEMICAL	AIR AND MULTI-PURPOSE	AIR DUCT	AIR BREATHING	AGRICULTURE
---------------------------	-------------	------------------------	--------	-------	-------	----------------------------	-----------	----------	--------	-------------------	-------------------	-------------------	----------	-----------------------	----------	---------------	-------------

### CHARACTERISTICS AND RESISTANCE INFORMATION FOR HOSE TUBE AND COVER COMPOUNDS

These ratings are for normal or usual range of the specified compounds. Many are also modified to meet the needs of specific applications. See notes below.

Elastomer Common Name or Trade Name ASTM	Poly Chloroprene Chloroprene CR	Acrylonitrile Butadiene Buna-N Nitrile NBR	Natural Rubber or Styrene Butadiene Gum Rubber, Buna-S NR or SBR	Polyvinyl Chloride (plasticized) PVC	Isobutylene & Isoprene Butyl IIR	Chlorinated Polyethylene CPE CM	Cross Linked Polyethylene Gatlon™ XLPE	Ultra high Molecular Weight Polyethylene UHMWPE UHPE	Chlorosulfonated Polyethylene Hypalon® CSM	Ethylene Propylene Diene EPDM EPDM	Fluorinated Polyethylene FEP FEP	Polyurethane Urethane EU	FluoroCarbon Fluoroelastomer FKM Viton® Fluorel® FKM	Polyamid Resins Nylon PA
Physical Strength	Good	Good	Excellent	Fair to Good	Fair to Good	Good	Good	Very Good	Good to Excellent	Good	Very Good	Excellent	Good	Good
<b>RESISTANCE TO</b>														
Abrasion	Good to Excellent	Fair to Good	Excellent	Good to Excellent	Fair to Good	Good	Good	Excellent	Good to Excellent	Good	Excellent	Excellent	Good to Excellent	Good to Excellent
Weather/Ozone	Good to Excellent	Poor	Poor to Fair	Excellent	Excellent	Good	Excellent	Good	Excellent	Excellent	Excellent	Fair to Good	Excellent	Excellent
Gas Permeation	Good	Good to Excellent	Good	Good	Excellent	Good	Good	Excellent	Good to Excellent	Fair to Good	Excellent	Fair to Good	Good	Excellent
Petroleum Oils	Excellent	Excellent	Poor	Good to Excellent	Poor	Good	Excellent	Excellent	Good to Excellent	Poor	Excellent	Good	Excellent	Excellent
Gasolines	Fair to Good	Excellent	Poor	Fair	Poor	Good	Excellent	Excellent	Fair	Poor	Excellent	Fair	Excellent	Excellent
High Temperatures	Good	Good to Excellent	Fair	Poor	Excellent	Excellent	Good	Fair	Good to Excellent	Excellent	Excellent	Fair	Excellent	Good
Low Temperatures	Fair to Good	Fair to Good	Good	Poor	Good	Good	Fair to Good	Fair	Fair	Fair to Good	Good	Excellent	Good	Excellent

- A2 White food-grade Chloroprene, complies with FDA (tube)
- B1 B2 Proprietary for special applications. Contact Denver Hose Product Application
- C2 Modification of Nitrile with increased ozone resistance (tube and cover)
- C3 Modification to Nitrile tube
- C4 Modification of Nitrile with excellent abrasion, tearing & gouging resistance (cover)
- D2 White food-grade Natural Rubber, complies with FDA (tube)
- D3 Natural Rubber
- G1 Modified PVC
- MQ Silicone Rubber
- P2 Special for Steam Hose applications

PHYSICAL PROPERTIES AFTER EXPOSURE TO OIL	
VOLUME CHANGE MAXIMUM	TENSILE STRENGTH RETAINED
Class A (High Oil Resistance)	+25% 80%
Class B (Medium Oil Resistance)	+65% 50%
Class C (Limited Oil Resistance)	+100% 40%

NOTE: Tube and cover compounds with the same name or Gates Type can differ between hoses. Compounds are designed for specific hose application requirements. Refer to the hose product sheet for recommended applications and restrictions. Example: Petroleum Transfer Hose Longhorn (Type C Nitrile) has a different Nitrile tube compound than Fuel Line 4219G (Type C Nitrile). Please read and observe all warnings in the front of this catalog.

## GATES CHEMICAL RATING SYSTEM

**NOTE:** Ratings are for the effect on the *polymer only*.

**“1” Preferred: Constant Contact**— This chemical is expected to have minor or no effect on the Polymer. Hose approved for continuous contact. Environmental changes such as temperature, concentration, etc., may promote increased degradation.

**“2” Acceptable: Intermittent Contact** — This polymer should give reasonably satisfactory service. Due to the nature of this chemical, and under prolonged continuous exposure, the rubber may show minor to moderate deterioration and/or solution discoloration. Hose intended for transfer service only and should be drained after each use. Environmental changes such as temperature, concentration, etc., may promote increased degradation.

**“X” Not Recommended** —The polymer is unsatisfactory for this chemical and should not be used.

**“-” (Dash)** —Insufficient or no data available for this material. Testing is advised.

**NOTE 1.** The above ratings as applied to the Chemical Resistance Table are intended as guides only. They are compiled from the best data available to us. Ratings shown in the table are based on 100% concentrated or saturated solutions, unless otherwise noted, and up to 100 F (+38°C), unless otherwise stated.

**NOTE 2.** If unusual conditions exist, a polymer test in the fluid is suggested.

**NOTE 3.** Where a chemical listed in the Resistance Table is soluble in a solvent other than water, the solvent should also be checked for its suitability with the polymer.

**NOTE 4.** Discoloration of fluids conveyed in the hose. There are no generally accepted standard tests for measuring or rating discoloration of fluids passing through a hose. The amount of discoloration that can be tolerated is usually established by the user on the basis of application. Obviously, products such as paint must be conveyed through a hose that has very good non-discoloring characteristics. If the product is not visually affected, then the hose is satisfactory. For some products, the discoloration may be objectionable from a visual standpoint. Also, the concentration of the particles causing the discoloration may be objectionable if they affect the final use of the

product.

Some of the more common methods of checking discoloration are:

1. Allowing the fluid to remain in a sample piece of hose for a specific period and expected operating temperature, then inspecting visually for discoloration.
2. Testing fluid as in No. 1 above and then passing it through filter paper to check foreign content.
3. A more refined test can be made with a spectrophotometer. This instrument measures light transmission through the fluid before and after immersion tests with rubber stocks. This gives a relative rating expressed in percent, the original fluid being rated at 100%.

If discoloration of the product becomes a serious problem for a specific application, contact Denver Product Application for a recommendation. Phone (303) 744-5070.

**NOTE 5.** Fluid permeation through the tube wall needs to be considered. A tube material may show no sign of degradation, however hose failure can occur if material permeates through the tube to degrade adhesive layers or reinforcement.

**Hose Coupling Material** — Gates recommends hose couplings made of six materials: Iron or Carbon Steel, 304SS, 316SS, Aluminum, Brass and Polypropylene. The Chemical Resistance Table includes columns showing the suitability of a specific coupling material for the chemicals listed. In most instances, at least one coupling material is rated for each chemical. For certain chemicals, other metallic alloys or plastics than those shown in the table are required. These are generally available from other coupling manufacturers, but are not stocked by Gates.

AGRICULTURE

AIR BREATHING

AIR DUCT

AIR AND MULTI-PURPOSE

CHEMICAL

FOOD AND BEVERAGE

MARINE AND ENGINE

MATERIAL HANDLING

MINING

OILFIELD

PETROLEUM

PRESSURE WASH AND WASHDOWN

STEAM

WATER

CLAMPS

COUPLINGS AND FERRULES

HOSE FINDER

CHEMICAL RESISTANCE TABLE

# Chemical Resistance Table

AGRICULTURE

AIR BREATHING

AIR DUCT

AIR AND MULTI-PURPOSE

CHEMICAL

FOOD AND BEVERAGE

MARINE AND ENGINE

MATERIAL HANDLING

MINING

OILFIELD

PETROLEUM

PRESSURE WASH AND WASHDOWN

STEAM

WATER

CLAMPS

COUPLINGS AND FERRULES

HOSE FINDER

CHEMICAL RESISTANCE TABLE

Contact Denver Product Application for recommendations for chemicals not listed.  
Phone (303) 744-5070

1 = Preferred - Constant Contact  
2 = Acceptable - Intermittent Contact  
X = Not Recommended  
- = No Data

NOTE: Ratings are for the effect on the polymer only!

Chemical	Form (at room temperature unless otherwise stated)	Gates Hose / Polymers														Couplings / Adapters							
		Chem Master™ Xtreme™ FEP	Chem Master™ Plus XLPE	Chem Master™ Plus UHMWPE	Food & Beverage Master	EPDM	NR	SBR	NR	Chloroprene	Butyl	Fluorocarbon	Hypalon®	CPE	Nylon	PVC	Iron/Carbon Steel	Stainless Steel 304	Stainless Steel 316	Aluminum	Brass	Polypropylene	
<b>A</b>																							
Absorption Oil	Liquid	1	2	2	X	X	1	X	X	2	X	1	2	1	1	-	-	-	-	-	-	1	-
Acetal	Colorless Liquid	1	1	1	1	1	-	-	-	-	1	X	-	1	-	-	-	-	-	-	-	1	-
Acetaldehyde	Colorless Liquid	1	1	1	1	X	2	2	X	1	X	X	1	X	X	1	1	1	1	1	1	1	1
Acetamide	Liquid above 176°F(80°C)	)	1	1	2	1	2	2	X	X	2	2	X	-	1	-	-	-	-	2	-	1	X
Acetic Acid (40% or less)	Clear Colorless Liquid	1	1	1	1	1	X	2	X	2	1	X	2	1	-	-	X	2	2	2	X	2	
Acetic Acid (56% or less)	Clear Colorless Liquid	1	1	1	1	1	X	2	X	2	1	X	2	1	X	2	X	2	2	2	X	2	
Acetic Acid (85% or less)	Clear Colorless Liquid	1	1	1	X	2	X	2	X	X	X	X	X	X	X	X	-	2	2	-	-	X	
Acetic Acid (Glacial - 99.4%)	Clear Colorless Liquid	1	1	X	X	X	X	2	X	X	X	X	X	1	X	X	-	2	2	-	-	X	
Acetic Acid, Anhydride	Clear Colorless Liquid	1	-	X	-	X	X	X	X	2	-	2	1	X	X	X	-	2	2	-	-	X	
Acetic Anhydride (Acetic Oxide)	Colorless Liquid	1	1	1	1	1	X	X	X	-	2	X	2	1	X	X	X	2	2	2	X	X	
Acetic Ether (Ethyl Acetate)	Colorless Liquid	1	1	1	2	2	X	X	X	X	2	X	2	1	X	1	1	1	1	1	1	2	
Acetic Oxide (Acetic Anhydride)	Colorless Liquid	1	1	1	1	1	-	X	X	-	2	X	2	1	X	X	X	2	2	2	X	X	
Acetone (Dimethylketone)	Colorless Liquid	1	1	1	1	2	X	X	X	X	2	X	X	1	1	X	1	1	1	1	1	2	
Acetone Cyanohydrin	Colorless Liquid	1	1	2	2	2	-	X	X	-	2	-	-	2	-	-	-	-	-	-	-	-	
Acetonitrile (Methyl Cyanide)	Colorless Liquid	1	1	2	1	X	X	2	2	2	2	-	2	1	-	1	-	-	-	-	-	-	
Acetophenone	Colorless Liquid	1	2	2	2	1	X	X	X	X	1	X	-	-	-	-	-	-	-	-	-	2	
Acetyl Chloride	Colorless Liquid	1	-	-	-	-	-	-	-	-	-	1	-	X	-	-	-	-	-	-	-	-	
Acetyl Oxide (Acetic Anhydride)	Colorless Liquid	1	1	1	1	1	X	X	X	-	2	X	2	1	X	X	X	2	2	2	X	X	
Acetyl-P-Toluidine (In Ether or Alcohols)	In Alcohol or Ether	1	1	1	1	1	-	X	X	-	2	X	-	1	-	-	-	-	-	-	-	-	
Acetylene	Gas	NO HOSE AVAILABLE														-	-	-	-	-	-		
Acetylene Dichloride (Dichloroethylene)	Colorless Liquid	1	X	X	X	X	-	X	X	-	X	1	-	X	1	X	-	-	-	-	-	X	
Acetylene Tetrachloride (Tetrachloroethane)	Colorless Liquid	1	X	X	X	X	-	X	X	-	X	1	-	X	1	X	-	-	-	-	-	-	
Acrolein (Hydroquinone Inhibited)	Colorless to Yellow Liquid	1	1	1	2	X	-	-	-	-	2	X	-	-	-	-	-	-	-	-	-	-	
Acrylamide	Colorless Crystals	1	1	2	2	-	-	-	-	-	1	-	-	-	-	-	-	-	-	-	-	-	
Acrylates (HEA or HPA)	Colorless Liquid	1	1	1	1	X	-	-	-	-	1	-	1	-	-	-	-	-	-	-	-	-	
Acrylic Acid	Colorless Liquid	1	1	1	1	-	-	-	-	-	1	-	2	-	-	-	-	-	-	-	-	-	
Acrylic Acid (Glacial 97%)	Colorless Liquid	1	1	1	X	X	X	X	X	X	1	X	X	X	X	X	-	-	-	-	-	-	
Acrylic Emulsion	Liquid	1	1	1	X	X	-	-	-	-	1	-	-	-	-	-	-	-	-	-	-	-	
Acrylonitrile	Colorless Liquid	1	2	2	1	X	X	2	2	X	X	X	X	1	-	1	1	1	1	-	-	-	
Adipic Acid (70°F)	White Crystals	1	1	X	1	1	X	X	1	X	-	1	-	-	X	X	-	-	-	-	-	-	
Aeroshell 7A, 17 Grease	Liquid	1	-	-	-	-	1	-	-	2	-	-	-	-	-	-	1	1	1	1	-	-	
Air, 212°F (100°C)	Colorless Gas	1	1	2	1	1	1	2	X	1	1	1	1	1	X	2	1	1	1	1	1	-	
Air, 257°F (125°C)	Colorless Gas	1	1	X	1	1	X	X	X	2	1	1	1	1	X	X	-	-	-	-	-	-	
Air, 300°F (149°C)	Colorless Gas	1	1	X	1	1	X	X	X	X	1	1	X	X	X	X	-	-	-	-	-	-	
Air, Ambient	Colorless Gas	1	1	1	1	1	1	1	1	1	1	1	1	1	1	1	1	1	1	1	1	1	
Aircraft Hyd. Oil AA	Liquid	1	1	-	-	X	1	-	-	-	X	-	-	-	-	-	1	1	1	1	1	-	
Atachlor (Lasso)	Colorless Crystals	1	1	-	-	-	-	1	-	-	-	-	-	-	-	-	-	1	1	-	-	-	
Alkaline Liquid (NOS)	In Water Solutions	1	1	1	1	1	-	-	-	-	1	2	-	1	-	-	-	-	-	-	-	-	
Alkaryl Polyether	Alcohol	-	1	1	1	-	-	-	-	-	-	-	1	-	1	-	-	-	-	-	-	-	
Alkyd Resin (Thermosetting Polymer)	Varies	1	1	-	-	-	-	-	-	-	-	-	-	-	-	-	-	-	-	-	-	-	
Alkylaryl Sulfonate (Alkylbenzene Sulfonate)	Powder	1	1	1	-	-	1	-	1	-	-	1	X	1	-	-	1	1	-	-	-	-	
Allomaleic Acid (Fumaric Acid) Solution	Liquid	1	1	-	-	2	1	2	2	-	-	1	-	-	-	X	-	1	1	-	-	-	
Allyl Alcohol	Colorless Liquid	1	1	1	1	1	1	-	1	1	1	1	1	1	X	X	-	-	-	-	-	-	
Allyl Bromide	Colorless to Yellow Liquid	1	-	-	-	-	-	-	-	-	-	-	-	-	-	-	-	-	-	-	-	-	
Allyl Chloride	Colorless Liquid	1	1	X	X	X	X	X	X	X	X	1	-	2	1	X	-	1	1	-	-	2	
Alpha Methylstyrene	Colorless Liquid	1	2	2	X	X	X	X	X	X	X	1	-	X	1	X	-	-	-	-	-	-	
Alpha Olefin Sulfonate	Powder	-	-	-	-	-	-	-	1	-	-	-	-	-	-	-	-	-	-	-	-	-	

# Chemical Resistance Table

Contact Denver Product Application for recommendations for chemicals not listed.  
Phone (303) 744-5070

- 1 = Preferred - Constant Contact
- 2 = Acceptable - Intermittent Contact
- X = Not Recommended
- = No Data

NOTE: Ratings are for the effect on the polymer only!

Chemical	Form (at room temperature unless otherwise stated)	Gates Hose / Polymers														Couplings / Adapters							
		Chem Master™ Xtreme™ FEP	Chem Master™ Plus XLPE	Chem Master™ Plus UHMWPE	Food & Beverage Master																		
		T	K	L	S	P	C	D	D	A	H	V	M	J	Z	G	Iron/Carbon Steel	Stainless Steel 304	Stainless Steel 316	Aluminum	Brass	Polypropylene	
Alpha Picoline	Colorless Liquid	1	1	-	-	-	-	-	-	-	-	-	-	-	-	-	-	-	-	-	-	-	
Alum (Aluminum Sulphate or Other)	White Crystals	1	1	-	1	1	1	1	1	1	-	-	-	X	-	-	X	X	2	X	X	1	
Alum, Potash (Aluminum Potassium Sulfate)	White Crystals	1	-	-	-	-	-	1	-	-	-	-	X	-	-	X	2	2	X	X	1		
Alumina - Calcined (Conveyed Pneumatically)	Granular	-	-	-	-	-	-	1	-	-	-	-	-	-	-	-	-	-	-	-	-		
Alumina Trihydrate (Conveyed Pneumatically)	White Crystalline Powder	-	-	-	-	-	-	1	-	-	-	-	-	-	-	-	-	-	-	-	-		
Aluminum Acetate	White Powder	1	1	-	-	-	1	1	-	-	-	-	-	-	-	1	1	-	X	-	-		
Aluminum Alkyl (ie Triethylaluminum)	Colorless Liquid	X	X	X	X	X	X	X	X	X	1	X	X	X	X	-	-	-	-	-	-		
Aluminum Bromide	White to Yellow Crystals	1	1	-	1	1	1	1	1	1	1	1	-	-	-	X	2	2	-	X	-		
Aluminum Chloride Solution	White to Yellow Solution	1	1	X	1	1	1	1	1	-	1	1	-	1	-	-	X	2	2	X	X	1	
Aluminum Chloride, Anhydrous	White to Yellow Crystals	-	-	-	-	-	-	1	-	-	-	-	-	-	-	-	-	-	-	-	-		
Aluminum Chlorohydrate Solution (Up to 50%)	White Solution	1	1	1	1	1	1	-	-	1	1	-	1	-	-	-	-	-	-	-	-		
Aluminum Fluoride	White Crystals	1	1	-	-	-	-	1	1	-	-	-	-	-	1	X	2	2	2	X	1		
Aluminum Formate (Di & Tri In Water)	In Hot Water	1	1	1	1	1	1	X	X	-	1	1	-	1	-	-	-	-	-	-	-		
Aluminum Hydroxide (Alumina Trihydrate)	In Mineral Acid or Caustic Soda	1	1	1	1	-	X	X	X	1	1	1	-	1	X	X	-	1	1	-	1	1	
Aluminum Nitrate	In Cold Water	1	1	1	1	1	1	1	1	1	1	1	1	-	1	X	1	1	2	-	1		
Aluminum Phosphate Solution	In HCl or HNO3 (slightly soluble)	1	1	1	-	-	X	X	X	X	-	1	-	-	X	X	-	-	-	-	-		
Aluminum Salts	Varies	1	1	-	-	1	1	1	1	1	1	-	1	-	-	1	-	2	2	2	-	1	
Aluminum Sulfate	White Crystals	1	1	-	1	1	1	1	1	1	-	-	-	-	-	X	X	2	X	X	1		
Aluminum Sulfate Solution	In Water	1	1	1	1	1	1	1	1	-	1	1	-	1	-	X	X	2	X	X	1		
Aluminum Sulfate Solution (49.7% H2O)	Liquid	1	1	1	1	1	1	1	1	1	1	-	1	1	1	X	X	2	X	X	1		
Amines (A class of Organic Compounds)	Varies	1	1	1	-	-	-	-	-	-	-	-	-	-	-	-	-	-	-	-	-		
Amines (Aromatic - IE P-Toluidine)	White Plates (Solid)	1	-	-	-	-	-	1	-	-	-	-	-	-	-	-	-	-	-	-	-		
Amines (Mixed)	Varies	1	2	1	-	2	2	2	2	2	2	X	-	-	-	-	1	-	X	X	-		
Amines (Primary, Secondary, Tertiary, Etc)	Varies	1	2	1	-	-	-	-	-	-	X	-	-	-	-	-	-	-	-	-	-		
Aminodiphenylamine	Purple Powder	1	2	-	-	-	-	-	-	-	-	-	-	-	-	-	-	-	-	-	-		
Aminoethanol (Ethanolamine)	Colorless Viscous Liquid	1	2	1	1	2	2	2	2	2	2	X	X	1	1	2	1	1	1	-	1	-	
Aminoethylethanolamine	Liquid	1	2	1	2	2	-	-	-	1	-	-	1	1	-	-	-	-	-	-	-		
Ammonia (Anhydrous)	Gas or Liquid	NO HOSE AVAILABLE																					
Ammonia (Aqueous up to 30% NH3)	Colorless Liquid	1	1	1	1	1	1	1	1	1	1	2	1	1	1	1	-	1	1	-	X	1	
Ammonia Liquor	Colorless Liquid	1	-	1	-	-	-	-	-	-	-	-	-	-	-	-	-	-	-	-	-	-	
Ammoniated Fatty Acid (ie Ammonium Caprylate)	Liquid above 167°F (75°C)	1	1	1	-	-	-	-	-	-	1	-	-	-	-	-	-	-	-	-	-		
Ammonium Acetate	In Water	1	1	1	1	1	1	1	1	1	2	1	1	-	1	2	1	-	1	1	-	X	1
Ammonium Bicarbonate	White Crystals	1	-	-	-	-	-	1	-	-	-	-	-	-	1	-	-	-	-	-	1		
Ammonium Bisulfate (50%)	Colorless Liquid	1	1	1	1	1	-	-	-	1	1	-	1	-	-	-	-	-	-	-	-		
Ammonium Carbonate	Colorless to White Powder	1	1	-	-	X	-	1	2	-	-	-	-	-	1	1	1	1	-	-	1		
Ammonium Chloride	White Crystals	1	-	X	-	-	-	1	-	-	-	-	-	-	-	-	-	2	2	-	X	1	
Ammonium Chloride Solution	Liquid	1	1	-	-	1	2	1	1	X	1	-	1	1	X	1	-	2	2	-	X	1	
Ammonium Flouride	White Crystals	-	-	-	-	-	-	1	-	-	-	-	-	-	-	-	-	-	-	-	-		
Ammonium Hydroxide (16%, 20%, 26%, & 30%)	Colorless Liquid	1	1	1	1	-	-	-	-	-	2	-	-	-	-	2	1	1	-	X	1		
Ammonium Hydroxide (up to 30% NH3)	Colorless Liquid	1	1	1	1	1	2	X	2	2	2	2	1	1	X	X	2	1	1	-	X	1	
Ammonium Metaphosphate	White Powder	1	1	-	-	1	2	2	2	1	-	2	-	-	2	1	1	1	X	-	1		
Ammonium Nitrate	Colorless Crystals	1	1	-	-	-	-	1	-	-	-	-	-	-	-	-	1	1	1	2	X	1	
Ammonium Nitrate Fertilizer (20.5% N, or 33.5% N)	Aggregate	1	-	-	-	-	-	1	-	-	-	-	-	-	-	1	1	1	2	X	1		
Ammonium Nitrate Prills and Oil	Aggregate	1	-	-	-	1	-	1	-	-	-	-	-	-	-	1	1	1	2	X	1		
Ammonium Nitrate Solution (up to 83%)	Liquid	1	1	1	1	1	1	-	1	1	-	1	1	1	-	1	1	1	2	X	1		
Ammonium Nitrite	Colorless Crystal	1	1	-	-	X	X	X	2	-	-	-	1	-	-	-	1	1	-	-	1		
Ammonium Persulfate	Solution in Water	1	1	-	-	X	-	X	-	X	-	-	-	-	-	-	1	1	-	X	X		
Ammonium Phosphate	White Crystals or Powder	1	-	-	-	-	-	1	-	-	-	-	-	-	-	X	2	1	X	-	1		

AGRICULTURE
AIR BREATHING
AIR DUCT
AIR AND MULTI-PURPOSE
CHEMICAL
FOOD AND BEVERAGE
MARINE AND ENGINE
MATERIAL HANDLING
MINING
OILFIELD
PETROLEUM
PRESSURE WASH AND WASHDOWN
STEAM
WATER
CLAMPS
COUPLINGS AND FERRULES
HOSE FINDER
CHEMICAL RESISTANCE TABLE

# Chemical Resistance Table

AGRICULTURE

AIR BREATHING

AIR DUCT

AIR AND MULTI-PURPOSE

CHEMICAL

FOOD AND BEVERAGE

MARINE AND ENGINE

MATERIAL HANDLING

MINING

OILFIELD

PETROLEUM

PRESSURE WASH AND WASHDOWN

STEAM

WATER

CLAMPS

COUPLINGS AND FERRULES

HOSE FINDER

CHEMICAL RESISTANCE TABLE

Contact Denver Product Application for recommendations for chemicals not listed.  
Phone (303) 744-5070

1 = Preferred - Constant Contact  
2 = Acceptable - Intermittent Contact  
X = Not Recommended  
- = No Data

NOTE: Ratings are for the effect on the polymer only!

Chemical	Form (at room temperature unless otherwise stated)	Gates Hose / Polymers																Couplings / Adapters					
		Chem Master™ Xtreme™ FEP	Chem Master™ Plus XLPE	Chem Master™ Plus UHMWPE	Sanitron™ Food & Beverage Master	EPDM	NR	SBR	NR	Chloroprene	Butyl	Fluorocarbon	Hypalon®	CPE	Nylon	PVC	Iron/Carbon Steel	Stainless Steel 304	Stainless Steel 316	Aluminum	Brass	Polypropylene	
		T	K	L	S	P	C	D	D	A	H	V	M	J	Z	G							
Ammonium Phosphate Solutions	Liquid	1	1	1	1	1	1	1	1	1	1	1	1	1	1	1	X	2	1	X	-	1	
Ammonium Polysulfide Solution	Yellow Solution	1	1	1	-	-	-	-	-	-	-	-	-	-	-	-	-	-	-	-	-	-	
Ammonium Sulfate	Gray to White Crystals	1	1	-	-	-	-	-	1	-	-	-	-	1	-	-	1	1	1	X	X	1	
Ammonium Sulfide	Yellow Crystals	1	1	-	-	-	-	-	1	-	-	-	-	-	-	-	1	1	1	X	X	1	
Ammonium Sulfide Solution (40-44% or less)	Liquid	1	1	-	-	1	2	1	1	-	1	1	1	1	-	1	1	1	1	X	X	1	
Ammonium Thiocyanate (50-60% less)	In Water	1	1	1	1	1	1	1	1	1	-	1	1	1	-	-	1	1	1	-	-	1	
Amyl Acetate (Banana or Pearl Oil)	Colorless Liquid	1	1	1	-	2	X	X	X	X	2	X	X	X	1	X	X	1	1	X	1	X	
Amyl Alcohol	Colorless Liquid	1	2	2	2	2	2	2	2	2	2	2	1	2	1	1	2	1	1	1	1	-	
Amyl Chloride (Chloropentane)	Colorless Liquid	1	-	-	-	-	-	-	-	-	-	-	-	-	-	X	-	1	1	-	-	X	
Amyl Chlorides (mixed)	Straw to Purple Liquid	1	2	2	X	X	X	X	X	X	X	1	X	X	1	X	-	1	1	-	-	X	
Amyl Chloronaphthalene	-	1	1	2	X	X	X	X	X	X	1	X	X	1	-	-	1	1	-	-	-	-	
Amyl Naphthalene	-	1	1	-	-	X	X	X	X	X	1	X	X	-	-	-	1	1	-	-	-	-	
Amyl Phenol	Clear Straw Colored Liquid	1	2	-	-	-	-	-	-	-	-	-	-	-	-	-	1	1	-	-	-	-	
Amylamine	Colorless Liquid	1	X	-	-	X	2	-	X	X	X	X	2	-	-	-	-	-	-	-	-	-	
Amylbenzene (sec amylbenzene)	Clear Liquid	1	2	2	X	X	2	X	X	2	X	1	-	-	-	-	-	-	-	-	-	-	
Anethole (anise camphor)	White Crystals/Liquid 73°F(23°C)	1	2	-	-	-	X	X	X	X	1	X	X	X	-	2	1	1	2	X	1	-	
Anhydrous Ammonia (R 717)	Gas or Liquid	NO HOSE AVAILABLE																-	-	-	-	-	-
Aniline	Colorless Oily Liquid	1	2	X	1	2	X	X	X	X	2	1	X	2	X	-	2	1	1	2	X	1	
Aniline Dyes	-	1	1	-	1	2	X	X	X	X	2	2	X	2	-	-	X	1	1	-	-	2	
Aniline Hydrochloride	White Crystals	1	1	-	-	2	2	2	2	X	2	-	-	-	-	-	X	X	-	X	2	-	
Aniline Oil (Aniline)	Colorless Oily Liquid	1	2	X	1	2	X	X	X	X	2	1	X	2	X	-	2	1	1	2	X	1	
Animal Fat (Lard)	White Solid/Liquid > 108°F(42°C)	1	1	1	X	X	1	X	X	2	X	1	X	1	1	-	1	1	1	1	X	-	
Animal Gelatin	-	1	-	1	-	-	1	-	-	1	-	-	-	-	-	1	-	1	1	-	-	-	
Animal Grease, Inedible, Liquid	Liquid	1	-	-	-	X	1	-	X	2	X	1	2	2	-	-	-	-	-	-	-	-	
Animal Oils	Solid to Liquid	1	-	-	2	-	1	-	2	-	-	-	-	1	1	1	1	1	1	1	-	-	
Ant Oil (Furfural)	Colorless to Reddish Brown Liquid	1	1	-	2	X	X	X	X	2	X	2	2	1	-	X	2	1	1	1	1	2	
Antifreeze (Glycol Base)	Liquid	1	1	2	1	1	1	1	1	1	1	1	1	1	1	1	1	1	1	1	1	1	
Antimony Chloride (50%)	White Powder	1	1	1	-	-	-	-	-	-	2	1	-	-	1	1	X	X	X	-	-	1	
Antimony Pentachloride	Reddish-Yellow Liquid	1	1	1	-	-	-	-	-	-	1	-	-	-	-	-	-	-	-	-	-	-	
Antimony Salts	White Crystal	1	1	-	-	1	2	-	-	-	1	1	-	-	-	1	-	-	-	-	-	-	
Aqua Ammonia (Ammonium Hydroxide) (30%)	Colorless Liquid	1	1	1	1	1	2	2	2	2	2	2	1	1	X	X	2	1	1	-	X	1	
Aqua Regia (Nitrohydrochloric Acid)	Fuming Yellow Liquid	1	2	X	X	X	X	X	X	X	X	1	X	2	X	X	-	X	X	-	X	-	
Argon, Compressed	Colorless Gas	1	1	1	1	1	1	1	1	1	1	1	1	1	1	1	-	-	-	-	-	-	
Aromatic Hydrocarbons	Typically Colorless Liquids	1	2	2	X	X	2	X	X	X	X	1	X	X	1	X	1	1	1	2	2	-	
Arsenic Acid	In Water	1	1	1	2	2	-	X	X	-	2	1	-	1	-	-	2	-	1	2	-	2	
Arsenic Trioxide	In Acid	1	1	1	2	X	2	X	X	2	X	1	X	-	-	1	-	-	-	-	-	-	
Askarel (Transformer Oil)	Varies	1	2	2	X	X	X	X	X	X	X	1	X	1	1	X	1	1	1	-	1	2	
Asphalt	Varies	1	2	X	X	X	2	X	X	-	X	1	-	-	X	X	1	1	1	-	1	-	
Asphalt (Blown)	Black Solid	-	-	X	-	-	-	-	1	-	-	-	-	-	-	-	-	-	-	-	-	-	
Asphalt (Cut Back)	Black Liquid	1	X	X	X	X	2	X	X	2	X	1	X	X	2	X	1	1	1	-	1	-	
Asphalt Emulsion	Black Liquid	-	-	X	-	-	-	-	-	-	-	-	-	-	-	-	-	-	-	-	-	-	
Asphalt Paint	Black Liquid	1	2	X	X	X	2	X	X	-	X	1	X	-	2	X	-	-	-	-	-	-	
Asphaltene	In Carbon Disulfide	1	2	X	X	X	2	X	X	2	X	1	X	X	1	-	-	-	-	-	-	-	
ASTM Oil No. 1	Brown Liquid	1	1	1	2	X	1	X	X	1	X	1	2	1	1	2	1	1	1	1	1	2	
ASTM Oil No. 2	Brown Liquid	1	1	1	X	X	1	X	X	2	X	1	2	1	1	X	1	1	1	1	1	X	
ASTM Oil No. 3	Brown Liquid	1	1	1	X	X	1	X	X	X	X	1	X	1	1	X	1	1	1	1	1	X	
ASTM Reference Fuel A	Liquid	1	1	1	2	X	1	X	X	1	X	1	1	1	1	2	1	1	1	1	1	X	
ASTM Reference Fuel B	Liquid	1	2	1	X	X	1	X	X	2	X	1	X	2	1	X	1	1	1	1	1	X	

# Chemical Resistance Table

Contact Denver Product Application for recommendations for chemicals not listed.  
Phone (303) 744-5070

- 1 = Preferred - Constant Contact
- 2 = Acceptable - Intermittent Contact
- X = Not Recommended
- = No Data

NOTE: Ratings are for the effect on the polymer only!

Chemical	Form (at room temperature unless otherwise stated)	Gates Hose / Polymers														Couplings / Adapters											
		Chem Master™ Xtreme™ FEP		Chem Master™ Plus XLPE		Chem Master™ Plus UHMWPE		Food & Beverage Master		P	C	D	D	A	H	V	M	J	Z	G	Iron/Carbon Steel	Stainless Steel 304	Stainless Steel 316	Aluminum	Brass	Polypropylene	
		T	K	L	S	EPDM	NR	SBR	NR																		Chloroprene
ASTM Reference Fuel C	Liquid	1	2	2	X	X	X	1	-	-	-	X	-	-	-	-	2	-	-	-	-	-	-	-	2		
ATF (Automatic Transmission Oil)	Liquid	1	1	1	X	X	1	-	-	-	X	1	-	1	-	-	-	-	-	-	-	-	-	-	-		
<b>B</b>																											
Baltic Types 100, 150, 200, 300, 500	Liquid	1	1	-	-	X	1	-	-	-	X	-	-	-	-	-	2	-	-	-	-	-	-	-	2		
Banvel (Ag Spray, Concentrated)	Liquid	1	1	-	-	-	-	-	-	-	-	-	-	-	-	-	1	-	-	-	1	-	-	-	-		
Bardot B	Dark Colored Liquid	1	1	-	-	X	X	X	X	X	X	2	X	-	-	-	1	1	1	-	-	-	-	-	-		
Barite (Natural Barium Sulfate)	White to Yellowish Powder	-	-	-	-	-	-	1	-	-	-	-	-	-	-	-	1	1	1	-	2	1	-	-			
Barium Carbonate	White Powder	1	1	-	-	X	1	X	1	1	X	1	X	1	-	1	2	1	1	-	1	1	-	-			
Barium Chloride	Colorless Crystals	1	1	1	1	1	1	1	1	1	1	1	1	1	X	1	X	1	1	-	2	1	-	-			
Barium Hydroxide	White Powder	1	1	1	-	1	1	X	1	1	1	-	1	1	-	X	2	1	1	-	-	-	-	-			
Barium Sulfate	White to Yellowish Powder	-	-	-	-	-	-	1	-	-	-	-	X	-	-	1	1	1	-	2	1	-	-				
Barium Sulfide	Yellowish Green to Gray Powder	1	1	1	-	-	-	1	-	-	1	-	1	-	-	X	1	1	-	X	1	-	-				
Basic Copper Arsenate	Blue to Green Powder	1	1	-	-	-	2	1	-	-	1	2	-	-	1	1	1	1	-	-	-	-	-				
BBP (Butyl Benzyl Phthalate)	Clear Oily Liquid	1	-	-	-	X	-	X	-	1	X	X	-	-	-	-	-	-	-	-	-	-	-	-			
Beer	Yellow Liquid	-	-	-	1	-	-	-	-	-	-	-	-	-	-	-	-	-	-	-	-	-	-	-			
Beet Sugar Liquors	Colorless Solution	1	1	1	1	1	1	1	1	1	1	1	1	1	1	1	X	X	X	X	-	X	-	X			
Bellows 80-20 Hydraulic Oil	Liquid	1	1	-	-	X	1	-	-	-	X	-	-	-	-	2	-	-	-	-	-	-	-	X			
Benzaldehyde (Benzoic Aldehyde)	Colorless to Yellow Liquid	1	1	1	2	2	X	X	X	X	2	X	X	X	2	X	1	-	-	1	-	1	-	-			
Benzene (Benzol)	Colorless to Yellow Liquid	1	2	2	X	X	X	X	X	X	1	X	X	1	X	1	1	1	1	1	1	1	1	X			
Benzenesulfonic Acid	Liquid above 151°F (66°C)	1	1	1	-	-	X	X	X	2	1	2	-	-	X	X	-	2	X	-	1	-	-	-			
Benzidine	Paste	1	2	-	-	X	2	X	1	X	X	-	-	-	X	1	1	1	1	1	1	1	X				
Benzoic Acid	White Crystals	1	1	1	1	2	X	X	X	X	2	1	2	1	-	X	-	-	-	-	-	-	-	-			
Benzoic Aldehyde (Benzaldehyde)	Colorless to Yellow Liquid	1	1	1	2	2	X	X	X	X	2	X	X	2	2	X	1	-	-	1	-	1	-	-			
Benzol (Benzene)	Colorless to Yellow Liquid	1	2	X	X	X	X	X	X	X	1	X	X	1	X	1	1	1	1	1	1	1	1	X			
Benzophenone	White Powder	1	1	-	-	-	-	1	-	-	1	-	-	1	-	-	-	-	-	-	-	-	-	-			
Benzotrithloride	Colorless to Yellow Liquid	1	-	-	X	X	X	X	X	X	1	-	X	2	X	-	-	-	-	-	-	-	-	-			
Benzyl Acetate	Water White Liquid	1	2	2	-	-	-	-	-	-	-	-	-	-	-	-	-	-	-	-	-	-	-	-			
Benzyl Alcohol	Water White Liquid	1	1	1	1	2	X	X	X	X	1	1	X	1	X	1	-	-	-	-	-	-	-	-			
Benzyl Alcohol, Photo Inhibited	Water White Liquid	1	-	-	-	-	-	-	-	-	-	-	-	-	-	-	1	1	1	-	-	-	-	-			
Benzyl Benzoate	Water White Liquid	1	1	-	-	2	-	-	-	-	2	1	-	-	-	-	1	1	1	-	-	-	-	-			
Benzyl Chloride	Colorless Liquid	1	2	2	X	X	X	X	X	X	1	-	X	2	X	1	-	-	-	-	-	-	-	-			
Bicarbonate of Soda	White Powder	-	-	-	-	-	-	1	-	-	-	-	-	-	-	-	-	-	-	-	-	-	-	-			
Bio-Diesel (B100)	Liquid below 125°F (52°C)	1	2	2	-	-	2	-	-	-	-	1	2	2	1	X	2	2	1	1	2	1	-	-			
Bio-Diesel (B100)	Liquid 125°F (52°C) and Above	1	X	X	X	X	X	X	X	X	1	X	X	1	X	2	2	1	1	2	1	-	-	-			
Bismuth Carbonate	White Powder	1	-	-	-	-	-	1	X	-	-	-	-	-	-	-	1	1	1	-	-	-	-	-			
Bisphenol A	White Flakes	-	-	-	-	-	-	1	-	-	-	-	-	-	-	-	-	-	-	-	-	-	-	-			
Bitumastic	Liquid	1	-	X	-	X	2	X	X	2	X	2	X	2	-	-	1	1	1	-	1	-	-	-			
Black Liquor (RXN Product Pulpwood+NaOH)	Black Alkaline Liquid	1	1	1	1	2	2	X	X	2	2	1	2	2	-	1	1	1	1	-	-	-	-	-			
Black Sulfate Liquor (See "Black Liquor")	Black Alkaline Liquid	1	1	1	1	2	2	X	X	2	2	1	2	X	-	1	1	1	1	-	-	-	-	-			
Blast Furnace Gas (Cooled)	Gas	1	1	-	-	-	X	X	X	X	1	X	2	-	X	1	1	1	1	-	1	-	-	-			
Bleach (Chlorinated Lime)	White Powder (35-37% Cl)	-	-	-	-	-	-	1	-	-	-	-	-	-	-	-	-	-	-	-	-	-	-	-			
Bleach Liquor (Calcium Hypochlorite/H2O)	Clear Solution	1	1	1	1	2	-	-	-	-	-	1	-	1	-	-	-	-	-	-	-	-	-	-			
Borax (Sodium Borate)	White Crystals	1	1	-	-	1	1	1	1	1	1	1	1	1	1	1	2	1	1	-	2	1	-	-			
Bordeaux Mixture (Slaked Lime & Copper Sulfate)	In Water	1	1	1	1	1	1	2	2	2	1	1	-	-	-	1	-	1	1	-	-	-	-	-			
Boric Acid	White Powder or Colorless Scale	1	1	1	1	1	1	1	1	1	1	1	1	1	1	X	1	X	2	1	1	1	X	1			
Boric Oxide	Colorless Powder	1	-	-	-	-	-	1	-	-	-	-	-	-	-	1	-	-	-	-	-	-	-	-			
Brake Fluid (Petroleum Base)	Liquid	1	1	-	X	X	1	X	X	2	X	1	X	1	1	2	1	1	1	-	1	1	-	-			
Brake Fluid (Synthetic) DOT2, DOT3, DOT4	Liquid	1	1	-	1	1	X	X	X	X	1	X	X	1	-	2	1	1	1	-	1	-	-	-			

AGRICULTURE
AIR BREATHING
AIR DUCT
AIR AND MULTI-PURPOSE
CHEMICAL
FOOD AND BEVERAGE
MARINE AND ENGINE
MATERIAL HANDLING
MINING
OILFIELD
PETROLEUM
PRESSURE WASH AND WASHDOWN
STEAM
WATER
CLAMPS
COUPLINGS AND FERRULES
HOSE FINDER
CHEMICAL RESISTANCE TABLE

# Chemical Resistance Table

AGRICULTURE

AIR BREATHING

AIR DUCT

AIR AND MULTI-PURPOSE

CHEMICAL

FOOD AND BEVERAGE

MARINE AND ENGINE

MATERIAL HANDLING

MINING

OILFIELD

PETROLEUM

PRESSURE WASH AND WASHDOWN

STEAM

WATER

CLAMPS

COUPLINGS AND FERRULES

HOSE FINDER

CHEMICAL RESISTANCE TABLE

Contact Denver Product Application for recommendations for chemicals not listed.  
Phone (303) 744-5070

1 = Preferred - Constant Contact  
2 = Acceptable - Intermittent Contact  
X = Not Recommended  
- = No Data

NOTE: Ratings are for the effect on the polymer only!

Chemical	Form (at room temperature unless otherwise stated)	Gates Hose / Polymers														Couplings / Adapters							
		Chem Master™ Xtreme™ FEP	Chem Master™ Plus XLPE	Chem Master™ Plus UHMWPE	Food & Beverage Master																		
		T	K	L	S	P	C	D	D	A	H	V	M	J	Z	G	Iron/Carbon Steel	Stainless Steel 304	Stainless Steel 316	Aluminum	Brass	Polypropylene	
Brine (Salt)	Liquid	1	1	1	1	1	1	1	1	1	1	1	1	1	1	1	2	1	1	-	2	1	
Bromine	Dark Reddish Brown Liquid	1	-	-	X	X	X	-	X	X	-	X	-	1	-	X	X	1	1	1	1	1	-
Bromobenzene	Colorless Liquid	1	-	-	X	X	-	X	X	-	X	1	-	-	-	X	-	-	-	-	-	-	
Bromochloroethane	Colorless Liquid	-	-	X	X	X	-	X	X	-	X	X	-	X	X	-	-	-	-	-	-	-	
Bromochloromethane (Chlorobromomethane)	Clear Liquid	1	2	X	X	X	X	X	X	X	X	X	X	X	X	X	1	1	1	-	1	X	
Bromotoluene	Clear Liquid	1	-	-	X	X	-	X	X	-	X	1	-	X	-	X	-	-	-	-	-	-	
Bubble Bath Compounds	Liquid	1	-	1	-	-	-	-	-	-	-	-	-	-	-	-	-	-	-	-	-	-	
Bunker Oil	Liquid	1	2	2	X	X	1	X	X	2	X	1	X	-	1	X	1	1	1	1	1	-	
Butadiene (1,3)	Gas	1	1	-	X	X	2	X	X	X	X	1	X	-	1	X	-	1	1	-	1	1	
Butanal (Butyraldehyde)	Water White Liquid	1	2	-	-	X	X	X	X	X	X	X	2	-	-	-	-	-	-	-	1	-	
Butandiol (Butylene Glycol)	Colorless Oily Liquid	1	1	2	-	-	-	-	-	-	-	1	-	-	X	-	-	-	-	-	-	-	
Butane (Gas)	Colorless Gas	USE LPG HOSE ONLY														-	-	-	-	-	-	-	
Butane (Liquid)	Liquid	USE LPG HOSE ONLY														-	-	-	-	-	-	-	
Butanol (Butyl Alcohol)	Colorless Liquid	1	1	1	1	1	1	1	1	2	1	1	2	1	1	1	1	1	1	1	1	1	
Butter	Yellow/White Semi-Solid/Liquid	-	-	-	2	-	-	-	-	-	-	-	-	2	-	-	-	-	-	-	-	-	
Butter Oil (Use FDA Hose)	Yellow to white Liquid	1	-	-	2	-	-	X	X	2	-	-	-	-	-	-	1	1	1	1	1	-	
Butyric Acid	Colorless Liquid	1	1	1	1	2	-	2	2	X	2	1	X	1	X	-	-	-	-	-	-	-	
Butyl Carbitol (Diethylene Glycol Butyl Ether)	Colorless Liquid	1	1	-	2	2	2	X	X	2	2	1	-	1	-	-	1	1	1	1	1	-	
Butyl Cellosolve (EG Monobutyl Ether)	Colorless Liquid	1	1	-	1	1	-	-	-	-	-	-	1	-	1	-	-	-	-	-	-	-	
Butyl "Oxitol™" for EG Monobutyl Ether	Colorless Liquid	1	1	-	1	1	-	-	-	-	-	-	1	-	1	-	-	-	-	-	-	-	
Butyl Acetate	Colorless Liquid	1	2	2	1	X	X	X	X	X	2	X	X	2	1	1	2	1	1	1	1	X	
Butyl Acrylate	Colorless Liquid	1	-	-	-	-	-	-	-	-	X	-	-	-	-	-	-	-	-	-	-	-	
Butyl Alcohol (Butanol)	Colorless Liquid	1	1	1	1	1	1	1	1	2	1	1	2	1	1	1	1	1	1	1	1	1	
Butyl Aldehyde	Water White Liquid	1	-	-	-	2	X	-	-	X	-	X	X	2	-	-	-	-	-	-	-	-	
Butyl Benzyl Phthalate (BBP)	Clear Oily Liquid	1	-	-	-	-	X	-	X	-	1	X	X	-	-	-	-	-	-	-	-	-	
Butyl Chloride	Colorless Liquid	1	-	-	-	-	-	-	-	-	-	1	-	X	-	-	-	-	-	-	-	-	
Butyl Ether	Colorless Liquid	1	1	-	-	-	2	X	X	2	2	X	-	1	-	-	1	1	1	1	1	-	
Butyl Ethyl Ether (Ethyl-n-Butyl Ether)	Liquid	1	-	-	-	-	2	-	X	-	X	-	2	-	-	-	-	-	-	-	-	-	
Butyl Formate	Colorless Liquid	1	-	-	-	X	-	X	X	-	-	-	-	-	-	-	-	-	-	-	-	-	
Butyl Mercaptan (2-Methyl-2-Butanathiol)	Liquid	1	1	-	X	X	-	X	X	-	X	1	-	-	-	X	-	1	1	-	-	-	
Butyl Methacrylate	Colorless Liquid	1	-	-	2	-	-	-	-	-	-	-	-	-	-	-	-	-	-	-	-	-	
Butyl Stearate	Colorless Liquid	1	1	-	-	X	2	X	X	X	X	1	-	2	-	1	1	1	1	1	1	-	
Butylamine	Colorless Liquid	1	1	-	-	-	X	X	X	X	X	X	2	-	-	1	1	1	1	1	1	X	
Butylene Glycol (Butandiol)	Colorless Oily Liquid	1	1	2	-	-	-	-	-	-	-	1	-	-	X	-	-	-	-	-	-	-	
Butyraldehyde (Butanal)	Water White Liquid	1	2	-	-	X	X	X	X	X	X	X	2	-	-	-	-	-	-	-	1	-	
Butyric Acid	Colorless Liquid	1	1	1	1	1	-	-	-	-	1	1	X	1	1	1	X	1	1	1	2	-	
Butyric Anhydride	Water White Liquid	1	-	-	-	-	-	-	-	-	-	-	-	-	-	-	-	-	-	-	-	-	
<b>C</b>																							
Cadmium Acetate (Soluble in H2O & Alcohols)	In Water or Alcohol	1	-	-	-	-	X	-	X	-	1	X	-	-	-	-	-	-	-	-	-	-	
Cake Alum (Aluminum Sulfate)	White Crystals	1	1	-	1	1	1	-	1	1	-	-	-	-	-	-	X	X	2	X	X	1	
Cake Alum Solution (Al Sulphate up to 50%)	In Water	1	1	1	1	1	1	-	-	-	1	1	-	1	1	1	-	-	-	-	-	-	
Calcine Liquor (Radioactive Waste)	In Water Solution	1	1	-	-	1	1	-	-	-	1	1	-	-	-	-	1	1	1	2	-	-	
Calcium Acetate	Powder	1	1	-	-	1	X	2	2	X	1	X	X	1	-	-	1	1	1	1	1	-	
Calcium Aluminate (Soluble in Acids)	In Acid	1	-	-	-	-	1	-	1	1	1	1	1	-	-	-	-	-	-	-	-	-	
Calcium Aluminate (Tricalcium Aluminate)	Crystals or Powder	1	-	-	-	-	-	1	-	-	-	-	-	-	-	-	-	-	-	-	-	-	
Calcium Arsenate	In Dilute Acid	1	1	-	-	-	-	-	-	-	-	1	-	-	-	1	-	-	-	-	-	-	
Calcium Bisulfide (Calcium Hydrosulfide)	In Alcohol or Water	1	1	-	-	-	1	2	2	1	1	1	1	1	-	2	-	2	1	-	X	1	

# Chemical Resistance Table

Contact Denver Product Application for recommendations for chemicals not listed.  
Phone (303) 744-5070

- 1 = Preferred - Constant Contact
- 2 = Acceptable - Intermittent Contact
- X = Not Recommended
- = No Data

NOTE: Ratings are for the effect on the polymer only!

Chemical	Form (at room temperature unless otherwise stated)	Gates Hose / Polymers																Couplings / Adapters			
		Chem Master™ Xtreme™ FEP	Chem Master™ Plus XLPE	Chem Master™ Plus UHMWPE	Food & Beverage Master																
		T	K	L	S	P	C	D	D	A	H	V	M	J	Z	G	Iron/Carbon Steel	Stainless Steel 304	Stainless Steel 316	Aluminum	Brass
FEP	Gaion™	UHMWPE	Sanitron™	EPDM	NR	SBR	NR	Chloroprene	Butyl	Fluorocarbon	Hypalon®	CPE	Nylon	PVC							
Calcium Bisulfite (Calcium Hydrogen Sulfite)	Yellow Liquid	1	1	-	-	-	-	2	1	1	1	1	1	1	1	1	1	1	1	1	1
Calcium Bromide Solution	In Water or Alcohol	1	1	1	1	-	-	-	-	-	-	1	-	-	-	-	-	-	-	-	-
Calcium Carbonate	Solid White Powder	1	1	-	-	1	1	1	1	1	1	1	1	1	1	1	1	1	1	1	1
Calcium Carbonate Slurry	Solid in H2O	1	-	-	-	1	1	1	1	1	1	1	-	-	-	-	-	-	-	-	-
Calcium Chlorate	In Water or Alcohol	1	1	-	-	2	1	2	2	1	2	-	1	-	-	1	-	2	1	-	1
Calcium Chloride, Dry	White Solid	-	-	-	-	-	-	-	1	-	-	-	-	-	-	X	2	1	-	2	1
Calcium Chloride, Liquid (Not For Food)	In Water or Alcohol	1	1	-	1	1	1	1	1	1	1	1	1	X	1	-	-	-	-	-	-
Calcium Chloride, Liquid, Food-grade 33%	In Water	1	-	-	-	1	1	1	1	1	1	1	1	1	1	-	-	-	-	-	-
Calcium Hydrogen Sulfite (Calcium Bisulfite)	Yellow Liquid	1	1	-	-	-	1	2	2	1	1	1	1	-	1	-	1	1	-	-	1
Calcium Hydrosulfide (Calcium Bisulfide)	In Alcohol or Water	1	1	-	-	1	2	2	1	1	1	1	1	-	2	-	2	1	-	X	1
Calcium Hydroxide (Hydrated or Slaked Lime)	Solid White Powder	1	1	-	1	-	2	1	1	1	1	X	1	1	-	X	X	X	1	-	2
Calcium Hydroxide Solutions	In Glycerol or Acids	1	1	X	-	-	2	-	-	-	-	-	-	X	-	2	1	1	X	X	-
Calcium Hypochlorite	Solid White Crystals	1	2	X	-	-	X	X	X	2	-	2	1	X	2	-	-	-	-	-	-
Calcium Hypochlorite Solutions	In Water or Alcohol	1	1	X	-	-	X	X	X	2	-	2	1	-	1	-	X	2	X	X	1
Calcium Metasilicate (Calcium Silicate)	White Powder	1	1	-	-	-	2	2	1	-	2	1	2	1	-	1	1	1	1	1	-
Calcium Nitrate Solutions	In Water, Alcohol, or Acetone	1	1	-	-	1	1	1	1	1	1	1	1	-	1	1	1	1	1	1	1
Calcium Oxide (Lime; quick, unslaked)	White to Gray Lumps	-	-	-	-	-	-	-	1	-	-	-	-	-	-	-	-	2	-	-	-
Calcium Silicate (Calcium Metasilicate)	White Powder	1	1	-	-	-	2	2	1	-	2	1	2	1	-	1	1	1	1	1	-
Calcium Stearate	White Powder	-	-	-	-	-	-	-	1	-	-	-	-	-	-	-	-	-	-	-	-
Calcium Sulfate	White Powder or Crystals	1	1	-	-	1	1	-	1	1	1	1	1	-	-	1	1	1	-	1	1
Calcium Sulfide	Yellow to Gray Powder	1	1	-	-	-	1	2	1	2	1	2	1	1	-	2	1	1	1	2	-
Calcium Sulfite (Soluble In Sulfurous Acid)	In Acid	1	1	1	1	1	-	-	-	-	X	1	-	1	-	-	-	-	-	-	-
Caliche Liquors (Sodium Nitrate)	In Water	1	1	-	-	-	1	2	2	-	1	-	1	-	-	-	-	1	1	-	-
Camphene (Liquid above 115°F/46°C)	Liquid above 115°F (46°C)	1	-	-	X	X	-	-	-	-	1	X	-	-	-	-	-	-	-	-	-
Cane Sugar Liquors	In Water	1	1	-	1	2	1	2	2	1	2	-	1	1	-	1	1	1	1	1	2
Caproic Acid	Colorless or Yellow Liquid	1	1	1	1	2	-	-	-	-	-	1	-	-	-	-	-	-	-	-	-
Caprolactam	White Flakes	-	-	-	-	-	-	-	1	-	-	-	-	-	-	-	-	-	-	-	-
Caprolactam, Molten (Above 156°F/69°C)	Liquid	-	-	-	-	-	-	-	-	-	-	-	-	-	X	-	-	-	-	-	-
Caprylic Acid (Octanoic Acid)	Colorless, Oily Liquid	1	-	-	-	-	-	-	-	-	-	-	-	1	-	-	-	-	-	-	-
Carbamates	Crystals	1	1	-	-	X	X	X	X	X	X	2	X	-	-	-	-	-	-	-	-
Carbolic Acid	Liquid above 109°F (43°C)	1	2	2	2	2	X	X	X	X	2	1	X	1	X	X	X	1	1	2	X
Carbolic Acid (Phenol)	White or Pink Crystals	1	2	-	2	2	X	X	X	X	2	2	X	1	X	X	X	1	1	2	X
Carbolic Acid (Phenol, 82-95% in Creosols)	Liquid	1	2	-	-	2	X	X	X	X	2	2	X	1	X	X	X	1	1	2	X
Carbon Dioxide (Dry)	Gas	1	1	-	-	1	1	1	1	1	1	1	1	-	1	1	1	1	1	1	1
Carbon Dioxide (Wet)	Gas with Water Vapor	1	1	1	-	2	1	2	2	1	2	1	1	-	-	1	1	1	1	1	1
Carbon Disulfide	Clear to Faint Yellow Liquid	1	2	1	-	X	2	X	X	X	X	1	X	2	1	X	2	1	1	2	X
Carbon Monoxide	Gas	1	2	1	-	1	2	X	X	2	X	1	1	-	-	1	1	1	1	1	1
Carbon Tetrachloride (Pyrene)	Colorless Liquid	1	2	X	X	X	X	X	X	X	X	1	X	X	1	X	X	2	2	X	X
Carbonic Acid	Liquid	1	1	1	1	1	1	1	1	1	1	1	1	-	X	X	1	1	2	X	1
Carbonyl Chloride (Phosgene)	Gas/Liquid	1	X	X	X	X	X	X	X	X	1	X	-	2	-	-	-	-	-	-	-
Casein (White amorphous solid)	In Concentrated Acid	1	-	-	-	-	-	-	-	-	-	1	-	-	-	1	-	-	-	-	-
Castor Oil	Pale Yellow or Colorless Liquid	1	1	-	-	-	1	X	X	1	2	1	1	1	-	1	1	1	1	1	1
Caustic Potash, Dry (Potassium Hydroxide)	White Pellets or Flakes	1	1	-	-	2	X	2	1	2	1	1	1	1	X	X	-	-	-	-	-
Caustic Potash, Liquid (up to 45%)	Solution in Water	1	1	1	1	2	2	2	2	-	1	2	-	1	1	1	-	-	-	-	-
Caustic Soda, Dry (Sodium Hydroxide)	White Beads or Pellets	-	-	-	-	-	-	-	1	-	-	-	-	-	-	-	-	-	-	-	-
Caustic Soda, Liquid (up to 73%)	Solution in Water	1	2	-	1	2	X	1	1	2	2	X	1	1	2	X	-	-	-	-	-
Cellosolve Acetate (Eg Ethyl Ether Acetate)	Colorless Liquid	1	1	-	-	2	X	-	-	-	-	X	-	X	-	1	1	1	1	-	1
Cellosolve Butyl (Eg Butyl Ether)	Colorless Liquid	1	1	-	-	2	X	-	-	-	-	X	-	1	-	1	1	1	1	-	1

AGRICULTURE
AIR BREATHING
AIR DUCT
AIR AND MULTI-PURPOSE
CHEMICAL
FOOD AND BEVERAGE
MARINE AND ENGINE
MATERIAL HANDLING
MINING
OILFIELD
PETROLEUM
PRESSURE WASH AND WASHDOWN
STEAM
WATER
CLAMPS
COUPLINGS AND FERRULES
HOSE FINDER
CHEMICAL RESISTANCE TABLE



# Chemical Resistance Table

AGRICULTURE
AIR BREATHING
AIR DUCT
AIR AND MULTI-PURPOSE
CHEMICAL
FOOD AND BEVERAGE
MARINE AND ENGINE
MATERIAL HANDLING
MINING
OILFIELD
PETROLEUM
PRESSURE WASH AND WASHDOWN
STEAM
WATER
CLAMPS
COUPLINGS AND FERRULES
HOSE FINDER
CHEMICAL RESISTANCE TABLE

Contact Denver Product Application for recommendations for chemicals not listed.  
Phone (303) 744-5070

1 = Preferred - Constant Contact  
2 = Acceptable - Intermittent Contact  
X = Not Recommended  
- = No Data

NOTE: Ratings are for the effect on the polymer only!

Chemical	Form (at room temperature unless otherwise stated)	Gates Hose / Polymers														Couplings / Adapters						
		Chem Master™ Xtreme™ FEP	Chem Master™ Plus XLPE	Chem Master™ Plus UHMWPE	Food & Beverage Master																	
		T	K	L	S	P	C	D	D	A	H	V	M	J	Z	G	Iron/Carbon Steel	Stainless Steel 304	Stainless Steel 316	Aluminum	Brass	Polypropylene
		FEP	Gafron™	UHMWPE	Sanitron™	EPDM	NR	SBR	NR	Chloroprene	Butyl	Fluorocarbon	Hypalon®	CPE	Nylon	PVC						
Cellulose	Solid, Many Forms	1	1	1	1	1	1	1	1	1	1	1	1	1	-	-	-	-	-	-	-	-
Cement, Portland	Gray Powder	1	-	1	-	-	-	-	-	1	-	-	-	-	-	-	-	-	-	-	-	-
China-Wood Oil (Tung Oil)	Yellow Oil	1	2	-	X	X	2	X	X	X	X	1	2	-	-	2	1	1	1	1	1	-
Chlordane	Colorless Viscous Liquid	1	1	-	-	X	X	-	-	X	-	1	X	-	1	2	-	-	-	-	-	-
Chlorinated Naphthalene (Chloronaphthalene)	Oily Liquid to Solid	1	-	-	-	X	X	X	X	X	X	1	X	-	-	-	-	-	-	-	-	-
Chlorinated Solvents (ie Tetrachloroethane)	Colorless Liquid	1	X	X	X	X	-	X	X	-	X	1	X	X	1	X	-	-	-	-	-	-
Chlorine	Gas	NO HOSE AVAILABLE														-	-	-	-	-	-	
Chlorine Liquid (Liquid @ 210PSIG @ 120°F/(38°C))	Clear Amber Liquid	1	-	-	-	X	-	-	-	-	-	1	-	-	X	X	-	-	-	-	-	-
Chlorine Trifluoride	Pale Green Liquid	1	-	-	-	X	-	-	-	-	-	1	-	-	-	X	-	-	-	-	-	-
Chlorine Water (.03%/300PPM Chlorine)	Clear, Yellowish Liquid	1	1	1	-	X	-	-	-	-	-	1	-	-	-	-	X	X	-	-	1	
Chloroacetic Acid (Monochloroacetic Acid)	Powder or White Crystals	1	1	X	X	X	X	X	X	X	X	1	2	-	-	-	-	-	-	-	-	-
Chloroacetic Acid (Under 100°F/38°C)	Solid	1	1	1	X	X	X	X	X	X	X	1	2	-	-	-	-	-	-	-	-	-
Chloroacetic Acid Solution	In Water, Alcohol, Ether	1	1	X	1	2	-	-	-	-	-	-	-	X	-	X	X	X	-	2	1	
Chloroacetone	Colorless Liquid	-	-	-	-	1	-	-	-	-	-	X	-	X	-	-	-	-	-	-	-	-
Chloroacetyl Chloride	Water White Liquid	1	-	-	-	-	-	-	-	-	-	-	-	-	-	1	-	-	-	-	-	-
Chloroaniline	Amber Liquid	1	-	-	-	-	-	-	-	-	-	-	-	-	-	-	-	-	-	-	-	-
Chlorobenzene (Phenyl Chloride) (Monochlorobenzene)	Clear Liquid	1	2	-	X	X	X	X	X	X	X	1	X	X	X	X	1	1	1	1	1	X
Chlorobromomethane (Bromochloromethane)	Clear Liquid	1	2	X	X	X	X	X	X	X	X	X	X	X	X	X	1	1	1	-	1	X
Chlorodifluoromethane (Freon 22)	Gas	SPECIAL HOSE REQUIRED														-	-	-	-	-	-	
Chloroethane (Ethylene Dichloride)	Colorless Liquid	1	2	2	X	X	X	X	X	X	X	1	X	X	X	X	-	-	-	-	-	-
Chloroform	Colorless Liquid	1	2	2	X	X	X	X	X	X	X	1	X	X	2	X	1	1	1	1	1	X
Chloronaphthalene (Chlorinated Naphthalene)	Oily Liquid to Solid	1	-	-	-	X	X	X	X	X	X	1	X	X	-	-	-	-	-	-	-	-
Chloropentane (n-amyl chloride)	Colorless Liquid	1	-	-	-	-	-	-	-	-	-	-	-	X	-	X	-	1	1	-	X	
Chlorophenol	In Benzene, Alcohol, Ether	1	2	-	-	-	-	-	-	-	-	-	-	-	-	-	-	-	-	-	-	-
Chloropicrin Mixture	Colorless Liquid	1	-	-	-	-	-	-	-	-	-	-	-	-	-	X	-	-	-	-	-	-
Chloropropylene Oxide (Epichlorohydrin)	Volatile Liquid	1	2	-	X	X	-	-	-	-	-	X	-	-	-	-	1	-	-	-	-	1
Chlorosulfonic Acid	Colorless to Light Yellow Liquid	NO HOSE AVAILABLE														-	-	-	-	-	-	
Chlorothene (TM for chlorinated solvents)	Colorless Liquid	1	1	X	-	-	X	-	-	X	-	2	-	-	-	-	-	1	1	-	1	-
Chlorotoluene	Colorless Liquid	1	-	-	X	X	X	X	X	X	X	1	X	X	-	X	1	1	1	1	1	-
Chlorox	Colorless Liquid	1	2	1	-	-	2	2	2	2	-	2	1	1	1	-	2	1	-	-	-	X
Chocolate Syrup	Liquid	-	-	-	1	-	-	-	-	-	-	-	-	-	1	1	-	-	-	-	-	-
Chrome Alum (Chromium Potassium Sulfate)	In Water	1	1	-	-	1	1	1	1	1	1	1	1	-	1	1	-	-	-	-	-	1
Chromic Acid (100%)	Dark Red Crystals	1	X	2	-	-	-	-	-	-	-	1	-	-	-	X	X	X	X	X	X	-
Chromic Acid (25% Solution or less)	In Water	1	1	1	1	2	X	X	X	X	X	1	2	1	X	X	X	X	2	X	X	1
Chromic Acid (50% Solution with water)	In Water	1	1	1	1	2	X	X	X	X	X	1	2	1	X	X	X	X	2	X	X	1
Chromic Acid (Chromium Trioxide)	Purplish-Red Crystals	1	X	2	-	-	-	-	-	-	-	1	-	-	-	X	X	X	2	X	X	1
Chromic Chloride	In Water	1	-	-	-	-	-	-	-	-	-	-	-	-	-	1	-	-	-	-	-	-
Chromium Trioxide (Chromic Acid)	Purplish-Red Crystals	1	X	2	-	-	-	-	-	-	-	1	-	-	-	X	X	X	2	X	X	1
Cider	Liquid	1	-	-	1	-	-	-	-	-	-	-	-	-	-	2	-	-	-	-	-	-
Cinene (Dipentene)	Colorless Liquid	1	2	-	X	X	X	X	-	-	-	1	-	-	-	-	-	-	-	-	-	-
Citgo FR Fuels	Liquid	1	1	-	-	1	X	-	-	-	1	-	-	-	-	2	-	-	-	-	-	-
Citric Acid Solution	In Water	1	1	1	1	1	X	2	2	1	2	1	1	-	X	1	X	X	1	1	X	2
Coal Gas (Coke Oven Gas, Max 120°F/49°C)	Gas	1	-	-	X	-	-	-	-	-	-	-	-	1	-	1	-	-	-	-	-	-
Coal Tar	Black, Viscous Liquid	1	-	-	X	X	2	X	X	2	X	1	X	2	X	X	1	1	1	1	1	-
Coal Tar Pitch (Roofing)	Liquid above 212°F (100°C)	1	-	-	X	X	2	X	X	2	X	1	2	2	-	X	-	-	-	-	-	-
Cobalt Nickel Plating Solution	Liquid	1	1	-	-	-	-	-	-	-	-	-	-	-	X	-	-	-	2	-	-	-
Cocoa Butter (Theobroma Oil)	Liquid above 95°F (35°C)	1	1	2	2	-	2	X	X	2	-	-	-	-	-	-	1	1	1	-	-	-

# Chemical Resistance Table

Contact Denver Product Application for recommendations for chemicals not listed.  
Phone (303) 744-5070

- 1 = Preferred - Constant Contact
- 2 = Acceptable - Intermittent Contact
- X = Not Recommended
- = No Data

NOTE: Ratings are for the effect on the polymer only!

Chemical	Form (at room temperature unless otherwise stated)	Gates Hose / Polymers														Couplings / Adapters						
		Chem Master™ Xtreme™ FEP	Chem Master™ Plus XLPE	Chem Master™ Plus UHMWPE	Food & Beverage Master																	
		T	K	L	S	P	C	D	D	A	H	V	M	J	Z	G	Iron/Carbon Steel	Stainless Steel 304	Stainless Steel 316	Aluminum	Brass	Polypropylene
Coconut Oil	Liquid above 77°F (25°C)	1	-	-	X	2	1	X	X	1	2	1	2	-	1	2	-	-	-	-	-	-
Cod Liver Oil	Pale Yellow Liquid	1	1	-	2	2	X	X	X	X	2	1	X	-	-	-	1	1	1	1	1	-
Coke Oven Gas (Under 300°F/149°C)	Gas	1	1	-	X	X	X	X	X	X	1	2	-	-	-	1	1	1	2	-	1	
Copper Arsenate (Cupric Arsenate)	In Dilute Acid	1	1	-	-	-	2	2	-	-	1	2	-	-	-	1	1	1	-	-	-	
Copper Chloride (Cupric Chloride)	In Water	1	1	-	-	-	2	2	2	2	2	1	2	2	X	1	X	X	1	-	X	1
Copper Cyanide (Cupric Cyanide)	In Dilute Acids or Alkalies	1	1	-	-	2	2	2	2	2	2	1	2	-	-	1	-	1	1	-	X	1
Copper Nitrate (Cupric Nitrate)	In Water	1	1	-	-	1	1	2	2	1	1	1	1	1	-	1	X	1	1	-	X	1
Copper Sulfate (Cupric Sulfate)	In Water	1	1	-	-	2	1	2	2	1	2	1	1	1	X	1	X	1	1	X	X	1
Copper Sulfide (Soluble in Nitric Acid)	In Nitric Acid	1	-	-	-	1	-	X	-	1	1	1	-	-	-	-	-	-	-	-	-	-
Corn Oil	Pale Yellow Liquid	1	1	-	2	2	2	X	X	2	2	1	X	2	-	1	1	1	1	1	1	X
Corn Syrup (Glucose Syrup)	Clear Liquid	1	2	-	1	2	2	2	2	2	2	2	-	-	-	1	1	1	1	-	-	-
Cottonseed Oil	Liquid, Several Colors	1	1	-	2	2	2	-	-	1	-	1	2	2	-	-	1	1	1	1	1	1
Creosote (high Naphthalene/Anthracene)	Liquid	X	2	X	X	-	2	X	X	X	2	1	X	-	-	X	2	1	1	1	X	2
Cresol (Methyl Phenol)	Liquid above 95°F (35°C)	1	2	-	-	-	X	X	X	X	2	1	X	1	X	-	2	1	1	1	-	2
Cresylic Acid	Liquid	1	-	-	-	X	X	X	X	X	1	X	-	X	-	-	-	-	-	-	-	-
Crotonic Acid (Methylacrylic Acid)	White Crystalline Solid	1	1	1	1	2	2	X	X	-	1	1	-	1	X	-	1	X	-	-	-	-
Crude Oil (Crude Petroleum Oil)	Liquid	1	1	-	X	X	1	X	X	2	X	1	2	2	-	1	1	1	1	1	1	1
Crude Wax	Liquid above 200°F (93°C)	1	2	-	-	-	2	-	-	-	2	1	-	-	-	1	1	1	1	-	1	1
Cryolite (Greenland Spar)	In Sulfuric Acid	1	2	-	-	X	1	X	X	2	X	1	X	-	-	-	1	1	1	-	1	X
Cumene (Isopropyl Benzene)	Colorless Liquid	1	2	-	X	-	-	-	-	-	1	-	2	-	-	-	-	-	-	-	-	-
Cupric Arsenate (Copper Arsenate)	In Dilute Acid	1	1	-	-	-	2	2	-	-	1	2	-	-	-	1	1	1	-	-	-	-
Cupric Chloride (Copper Chloride)	In Water	1	1	-	-	-	2	2	2	2	2	1	2	2	X	1	X	X	1	-	X	1
Cupric Cyanide (Copper Cyanide)	In Dilute Acids or Alkalies	1	1	-	-	2	2	2	2	2	2	1	2	-	-	1	-	1	1	-	X	1
Cupric Nitrate (Copper Nitrate)	In Water	1	1	-	-	1	1	2	2	1	1	1	1	1	-	1	X	1	1	-	X	1
Cupric Sulfate (Copper Sulfate)	In Water	1	1	-	-	2	1	2	2	1	2	1	1	1	X	1	X	1	1	X	X	1
Cutting Oil (Mineral Oil Base)	Liquid	1	2	-	-	X	1	X	X	2	X	1	X	-	-	-	1	1	1	-	1	X
Cutting Oil, Sulfur Base	Liquid	2	-	-	-	-	1	-	-	X	-	-	-	-	-	-	1	1	1	-	1	1
Cutting Oil, Water Soluble	Liquid	1	-	-	-	-	1	-	-	X	-	-	-	-	-	-	1	1	1	-	1	1
Cyanide, Copper (Cupric Cyanide)	In Dilute Acids or Alkalies	1	1	-	-	2	2	2	2	2	2	1	2	-	-	1	-	1	1	-	X	1
Cyanide, Mercuric	In Water	1	1	-	-	2	2	2	2	1	2	-	1	-	-	-	-	-	X	-	1	-
Cyanide, Potassium	In Water	1	-	-	-	-	-	-	-	-	-	-	1	-	-	-	-	-	-	-	-	-
Cyanide, Silver	In Nitric Acid	1	1	-	-	-	-	-	-	1	-	-	-	-	-	1	-	-	-	-	-	1
Cyanide, Sodium	In Water	1	1	-	-	1	1	1	1	1	1	1	1	1	1	1	2	1	1	X	X	-
Cyclohexane	Colorless Liquid	1	2	1	-	X	2	X	X	X	X	1	X	1	-	X	1	1	1	-	1	X
Cyclohexanol	Colorless, Oily Liquid	1	2	-	-	X	2	X	X	2	X	1	2	1	-	X	-	-	-	-	-	1
Cyclohexanone	Colorless to Yellow Liquid	1	1	-	-	X	X	X	X	X	X	X	X	-	X	-	1	1	2	-	X	-
Cyclohexylamine	Colorless Liquid	-	-	-	-	1	-	X	-	-	1	X	-	-	-	-	-	-	-	-	-	-
Cyclopentane	Colorless Liquid	1	-	-	-	X	2	-	X	2	X	1	X	2	-	-	-	-	-	-	-	-
Cyclopentanol	Colorless Liquid	1	-	-	-	2	-	X	-	X	2	X	1	-	-	-	-	-	-	-	-	-
Cyclopentanone	Water White Liquid	-	-	-	-	X	-	X	-	X	X	X	-	-	-	-	-	-	-	-	-	-
Cymene	Colorless Liquids	1	2	-	-	X	X	X	X	X	X	2	X	2	-	X	1	1	1	1	1	-
Cymene (Isopropyltoluene)	Colorless Liquid	1	-	-	-	-	-	-	-	-	-	1	-	-	1	-	1	1	1	1	1	-
<b>D</b>																						
Decalin (TM for decahydronaphthalene)	Colorless Liquid	1	2	2	X	X	2	X	X	-	X	1	X	2	1	-	-	-	-	-	1	1
Decanal (Decyl Aldehyde)	Colorless to Yellow Liquid	1	-	-	-	-	X	-	X	-	X	X	-	-	-	-	-	-	-	-	-	-
Decanol (Decyl Alcohol)	Colorless, Water White Liquid	1	-	-	-	-	1	-	X	X	X	2	2	1	-	X	-	-	-	-	-	-
Decyl Aldehyde (n-decanal)	Colorless to Yellow Liquid	1	-	-	-	-	X	-	X	-	X	X	-	-	-	-	-	-	-	-	-	-
Deicing Fluid (ethylene or propylene glycol)	Orange Liquid	1	1	1	1	1	1	-	-	1	1	1	2	1	-	1	2	1	1	1	1	1

AGRICULTURE
AIR BREATHING
AIR DUCT
AIR AND MULTI-PURPOSE
CHEMICAL
FOOD AND BEVERAGE
MARINE AND ENGINE
MATERIAL HANDLING
MINING
OILFIELD
PETROLEUM
PRESSURE WASH AND WASHDOWN
STEAM
WATER
CLAMPS
COUPLINGS AND FERRULES
HOSE FINDER
CHEMICAL RESISTANCE TABLE

# Chemical Resistance Table

AGRICULTURE

AIR BREATHING

AIR DUCT

AIR AND MULTI-PURPOSE

CHEMICAL

FOOD AND BEVERAGE

MARINE AND ENGINE

MATERIAL HANDLING

MINING

OILFIELD

PETROLEUM

PRESSURE WASH AND WASHDOWN

STEAM

WATER

CLAMPS

COUPLINGS AND FERRULES

HOSE FINDER

CHEMICAL RESISTANCE TABLE

Contact Denver Product Application for recommendations for chemicals not listed.  
Phone (303) 744-5070

1 = Preferred - Constant Contact  
2 = Acceptable - Intermittent Contact  
X = Not Recommended  
- = No Data

NOTE: Ratings are for the effect on the polymer only!

Chemical	Form (at room temperature unless otherwise stated)	Gates Hose / Polymers														Couplings / Adapters						
		Chem Master™ Xtreme™ FEP	Chem Master™ Plus XLPE	Chem Master™ Plus UHMWPE	Sanitron™ Food & Beverage Master	EPDM	NR	SBR	NR	Chloroprene	Butyl	Fluorocarbon	Hypalon®	CPE	Nylon	PVC	Iron/Carbon Steel	Stainless Steel 304	Stainless Steel 316	Aluminum	Brass	Polypropylene
		T	K	L	S	P	C	D	D	A	H	V	M	J	Z	G						
Denatured Alcohol	Colorless Liquid	1	1	1	1	1	1	1	1	1	1	1	1	1	1	1	1	1	1	1	1	1
Detergent Sol. (Sodium dodcylbenzenesulfonate)	In Water	1	2	1	1	1	1	X	X	2	1	-	1	-	-	1	2	1	1	1	1	1
Developing Solutions (Hypos)	Liquid	1	1	-	-	-	-	2	2	2	2	-	2	-	-	1	-	1	1	-	-	-
Dextron	Brown Liquid	1	X	-	-	X	1	-	-	-	X	-	-	1	1	2	-	-	-	-	-	-
Dextrin (Starch gum)	Yellow or White Powder	1	1	-	-	1	1	-	-	1	X	1	-	-	1	1	-	1	1	-	-	1
Diacetone	Colorless Liquid	1	1	-	-	2	X	X	X	X	2	X	X	1	1	X	1	1	1	-	1	1
Diacetone Alcohol	Colorless Liquid	1	1	-	-	X	2	2	-	2	X	2	1	-	X	1	1	1	1	1	1	1
Diammonium Phosphate	In Water	1	1	-	-	1	1	1	1	1	1	-	1	-	-	1	X	2	1	X	-	1
Diazinon	In Petroleum Solvents	1	-	-	-	1	-	1	1	-	-	1	-	-	-	2	-	-	-	-	-	2
Dibenzyl Ether	Colorless Liquid	1	1	-	-	2	X	X	X	X	2	X	X	X	-	-	1	1	1	1	1	-
Dibutyl Ether	Colorless Liquid	1	1	-	-	-	X	X	X	X	2	X	X	1	-	-	1	1	1	1	1	-
Dibutyl Phthalate	Colorless Oily Liquid	1	1	-	-	1	X	X	X	X	2	2	X	X	-	1	1	1	1	1	1	2
Dibutylamine	Colorless Liquid	1	-	-	X	X	X	X	X	X	X	X	X	-	X	-	-	-	-	-	-	-
Dibutylsebacate	Clear Colorless Liquid	1	1	-	-	X	X	X	X	X	2	1	-	2	-	-	-	-	-	-	1	-
Dichloroacetic Acid	Colorless Liquid	1	-	-	-	X	-	2	-	X	X	X	-	-	-	-	-	-	-	-	-	-
Dichloroaniline	In Alcohol or Benzene	1	-	-	-	X	X	X	-	X	X	2	-	-	-	-	-	-	-	-	-	-
Dichlorobenzene (ortho)	Colorless Liquid	1	2	-	X	X	X	X	X	X	1	X	X	1	X	-	1	1	-	1	-	-
Dichlorobenzene (para)	White Crystals	1	2	-	-	X	X	X	X	X	1	X	X	1	X	-	1	1	-	1	-	-
Dichlorobenzyl Chloride	Colorless Liquid	1	2	-	X	X	X	X	X	X	1	X	X	-	X	-	-	-	-	-	-	-
Dichlorodifluoromethane (Freon 12)	Gas, Liquid-140PSIG @ 100°F (38°C)	SPECIAL HOSE REQUIRED														-	-	-	-	-	-	-
Dichloroethane (Ethylene Dichloride)	Colorless Oily Liquid	1	2	2	X	X	X	X	X	X	2	X	X	X	X	-	-	-	-	-	-	-
Dichloroethyl Ether	Colorless Liquid	1	-	-	-	-	X	-	X	-	X	-	X	-	-	-	-	-	-	-	-	-
Dichloroethylene	Colorless Liquid	1	2	X	-	X	X	X	X	X	1	X	-	-	-	-	-	-	-	-	-	X
Dichloroethylene (Acetylene Dichloride)	Colorless Liquid	1	X	X	X	-	X	X	-	X	1	-	X	1	X	-	-	-	-	-	-	X
Dichloromethane (Methylene Chloride)	Colorless Liquid	1	1	2	X	X	X	X	X	X	2	X	X	X	X	1	1	1	1	-	1	-
Dichloropentane	Light Yellow Liquid	1	-	-	-	X	X	X	X	X	1	X	-	-	-	-	-	-	-	-	-	-
Dichloropropane (Propylene Dichloride)	Colorless Liquid	1	-	-	-	X	X	X	X	X	2	X	-	-	-	-	-	-	-	-	-	-
Dicyclohexylamine	Colorless Liquid	1	-	-	-	X	-	X	X	X	X	X	-	-	-	-	-	-	-	-	-	-
DIDA (Diisodcyl Adipate)	Light Colored Oily Liquid	1	-	-	-	-	X	-	X	-	1	X	X	-	-	-	-	-	-	-	-	-
Diesel Fuel	Liquid	1	2	1	X	X	1	X	X	2	X	-	X	-	1	-	1	1	1	1	1	2
Diethanolamine (20%)	In Water or Alcohol	1	-	-	1	2	2	2	2	2	X	1	1	2	1	1	2	1	1	1	1	X
Diethanolamine	Liquid above 83°F (29°C)	1	-	-	1	-	-	-	-	-	-	-	-	-	-	-	1	1	1	1	1	X
Diethyl Ether (Ethyl Ether)	Colorless Liquid	1	2	-	1	X	X	X	X	X	2	X	X	1	-	2	2	1	1	1	1	1
Diethyl Ketone	Colorless Liquid	1	-	-	-	2	X	-	X	X	2	X	X	-	-	X	-	-	-	-	-	-
Diethyl Oxalate	Colorless Oily Liquid	1	-	-	-	X	X	-	X	X	-	X	-	-	X	-	-	-	-	-	-	-
Diethyl Phthalate (Ethyl Phthalate)	Water White Liquid	1	1	-	-	-	X	X	X	-	2	-	-	2	-	-	-	1	1	-	1	-
Diethyl Sebacate	-	1	1	-	-	-	X	X	X	X	2	2	X	2	-	-	-	1	1	-	1	-
Diethyl Sulfate	Colorless Liquid	1	-	-	-	1	X	1	X	1	2	X	X	-	-	-	-	-	-	-	-	-
Diethyl Sulfide (Ethyl Sulfide)	Colorless Oily Liquid	1	1	-	-	-	-	-	-	-	-	1	-	-	-	-	-	-	-	-	-	-
Diethylacetaldehyde (Ethylbutyraldehyde)	Colorless Liquid	1	1	-	-	-	-	-	-	-	-	-	-	-	-	-	-	-	-	-	-	-
Diethylamine	Colorless Liquid	-	-	2	-	-	-	-	-	-	-	-	-	-	-	-	-	1	1	-	1	1
Diethylbenzene	Colorless Liquid	1	1	-	-	X	-	X	X	-	X	1	-	2	-	-	-	-	-	-	-	-
Diethylene Dioxide (1,4 Dioxane)	Colorless Liquid	1	1	-	1	2	X	X	X	X	2	X	X	2	1	X	1	1	1	1	1	1
Diethylene Ether (Dioxane)	Colorless Liquid	1	1	-	1	2	X	X	X	X	2	X	X	2	1	X	1	1	1	1	1	1
Diethylene Glycol (Dihydroxydiethyl Ether)	Colorless Syrupy Liquid	1	1	-	1	1	1	1	1	1	1	1	-	1	1	1	1	1	1	1	1	1
Diethylene Glycol Methyl Ether (Methyl Cellosolve)	Colorless Liquid	1	1	-	1	1	-	X	X	-	X	1	X	1	-	-	-	-	-	-	-	-
Diethylene Glycol Monobutyl Ether	Colorless Liquid	1	1	-	1	1	-	-	-	-	-	1	-	-	-	-	-	-	-	-	-	-
Diethylene Glycol Monobutyl Ether Acetate	Colorless Liquid	1	1	-	1	1	-	-	-	-	-	-	-	-	-	-	-	-	-	-	-	-

# Chemical Resistance Table

Contact Denver Product Application for recommendations for chemicals not listed.  
Phone (303) 744-5070

- 1 = Preferred - Constant Contact
- 2 = Acceptable - Intermittent Contact
- X = Not Recommended
- = No Data

NOTE: Ratings are for the effect on the polymer only!

Chemical	Form (at room temperature unless otherwise stated)	Gates Hose / Polymers														Couplings / Adapters						
		Chem Master™ Xtreme™ FEP	Chem Master™ Plus XLPE	Chem Master™ Plus UHMWPE	Sanitron™ Food & Beverage Master	EPDM	NR	SBR	NR	Chloroprene	Butyl	Fluorocarbon	Hypalon®	CPE	Nylon	PVC	Iron/Carbon Steel	Stainless Steel 304	Stainless Steel 316	Aluminum	Brass	Polypropylene
		T	K	L	S	P	C	D	D	A	H	V	M	J	Z	G						
Diethylene Glycol Monoethyl Ether	Colorless Liquid	1	1	-	1	1	-	-	-	-	-	-	-	-	-	-	-	-	-	-	-	-
Diethylene Glycol Monomethyl Ether	Colorless Liquid	1	1	-	1	1	-	-	-	-	-	-	-	-	-	-	-	-	-	-	-	-
Diethylene Glycol Monomethyl Ether Acetate	Colorless Liquid	1	1	-	1	1	-	-	-	-	-	-	-	-	-	-	-	-	-	-	-	-
Diethylenetriamine	Yellow Liquid	1	1	1	-	1	-	X	-	X	1	X	X	-	-	-	-	-	-	-	-	-
Dihydroxyacetone	In Water	1	1	-	1	1	-	-	-	-	-	-	-	-	-	-	-	-	-	-	-	-
Dihydroxydiethyl ether (Diethylene glycol)	Colorless Syrupy Liquid	1	1	1	1	1	1	1	1	1	1	1	1	-	1	1	1	1	1	1	1	1
Diisobutyl Ketone	Colorless Liquid	1	1	-	1	1	X	X	X	X	2	X	X	2	1	-	-	1	1	-	1	1
Diisobutyl Phenol (Octyl Phenol)	White Flakes	1	-	-	-	-	-	-	1	-	-	-	-	-	-	-	-	-	-	-	-	-
Diisobutyl Phthalate	Liquid	1	1	-	-	-	-	-	-	-	-	-	-	-	-	-	-	-	-	-	-	-
Diisobutylene	Colorless Liquids	1	1	-	X	X	2	X	X	X	X	1	X	2	-	-	-	1	1	-	1	-
Diisodecyl Adipate (DIDA)	Light Colored Oily Liquid	1	-	-	-	-	X	-	X	-	1	X	X	-	-	-	-	-	-	-	-	-
Diisooctyl Phthalate (DIOP)	Nearly Colorless Liquid	1	-	-	-	1	X	-	X	-	1	X	X	-	-	-	-	-	-	-	-	-
Diisopropanolamine	Liquid above 108°F (42°C)	1	-	-	-	-	2	-	2	-	1	-	-	-	-	-	-	-	-	-	-	-
Diisopropyl Ketone	Colorless Liquid	1	1	-	1	1	X	X	X	X	2	X	X	-	1	-	-	1	1	-	1	-
Diisopropylamine	Colorless Liquid	1	1	-	-	-	-	-	-	-	-	-	-	-	-	-	-	-	-	-	-	-
Diisopropylbenzene (meta)	Colorless Liquid	1	2	2	X	X	-	-	-	-	-	1	-	-	-	-	-	-	-	-	-	-
Diisopropylidene Acetone (Phorone)	Yellow Liquid	1	1	-	-	2	X	X	X	X	2	X	X	-	-	-	1	1	1	-	1	-
Dilauryl Ether	Liquid above 92°F (33°C)	1	1	-	1	1	-	-	-	-	-	X	-	-	-	-	-	-	-	-	-	-
Dimethyl Acetamide (DMAC)	Colorless Liquid	1	1	-	-	-	-	-	-	-	-	-	-	-	-	-	-	-	-	-	-	-
Dimethyl Aniline	Yellow/Brown Oily Liquid	1	1	-	-	X	X	X	X	X	2	1	X	2	-	-	-	-	-	-	1	-
Dimethyl Ether	Liquid under Pressure	1	1	1	1	1	X	X	X	X	2	X	X	-	-	-	1	1	1	1	1	-
Dimethyl Formamide	Water White Liquid	1	1	-	1	2	-	-	-	-	-	X	-	-	-	-	1	1	1	-	-	1
Dimethyl Phthalate	Colorless Oily Liquid	1	1	-	1	2	X	X	X	X	2	1	X	1	-	-	-	-	-	-	1	-
Dimethyl Sulfate (Methyl Sulfate)	Colorless Liquid	1	1	-	-	X	X	X	X	X	2	X	X	-	1	1	-	-	-	-	-	-
Dimethyl Sulfide	Colorless Liquid	1	1	-	-	-	-	-	-	-	-	1	-	-	-	-	-	-	-	-	-	-
Dimethyl Sulfoxide	Colorless Liquid	1	1	-	-	-	-	-	-	-	-	1	-	-	-	-	-	-	-	-	-	-
Dimethyl Terephthalate	Colorless Crystals	-	-	-	-	-	X	X	-	X	X	1	-	-	-	-	-	-	-	-	-	-
Dimethylamine (DMA)	Liquid @ 70PSIG @ 120°F (49°C)	1	1	1	-	-	-	-	-	-	-	-	-	-	-	-	-	-	-	-	-	-
Dimethylaminoethanol (Dimethylethanolamine)	Colorless Liquid	1	1	-	1	2	-	-	-	-	-	-	-	-	-	-	-	-	-	-	-	-
Dimethylaminomethyl Phenol (DMP)	Dark Red Liquid	1	1	-	-	-	-	-	-	-	-	1	-	-	-	-	-	-	-	-	-	-
Dimethylbenzene (DMB)	Colorless Liquid	1	X	X	X	X	X	X	X	X	X	1	X	X	X	X	-	-	-	-	-	-
Dimethylcarbinol (isopropyl alcohol)	Colorless Liquid	1	1	1	1	1	1	2	2	2	1	1	2	1	1	2	1	1	1	1	2	1
Dimethylcyclohexylamine	Water White Liquid	1	1	-	-	-	-	-	-	-	-	-	-	-	-	-	-	-	-	-	-	-
Dimethylformamide (DMF)	Water White Liquid	1	2	-	-	-	-	-	-	-	-	X	-	-	-	-	1	1	1	-	-	1
Dimethylketone (Acetone)	Colorless Liquid	1	1	X	1	2	X	X	X	X	2	X	X	1	1	X	1	1	1	1	1	2
Dimethylphenol (Xylenol)	White Solid, Liquid @ 68°F (20°C)	1	1	-	-	-	-	-	-	-	-	1	-	-	-	-	-	-	-	-	-	-
Dinitrobenzene (Soluble in Chloroform)	In Chloroform	1	2	-	X	X	-	-	-	-	-	1	-	-	-	-	-	-	-	-	-	-
Dinitrogen Tetroxide (Nitrogen Dioxide)	Liquid @ 50PSIG @ 120°F (49°C)	1	-	-	-	-	-	-	-	-	-	1	-	-	-	-	-	-	-	-	-	-
Dinitrotoluene, Solid	In Alcohol or Ether	1	1	1	1	1	-	-	-	-	-	X	-	-	-	-	-	-	-	-	-	-
Diocetyl Adipate di (2-ethylhexyl) adipate	Light Colored Oily Liquid	1	1	-	-	-	-	-	-	-	-	1	-	-	-	-	-	-	-	-	-	-
Diocetyl Phosphite, di-(2-ethylhexyl) phosphite	Colorless Liquid	1	1	-	1	X	-	-	-	-	-	1	-	-	-	X	-	-	-	-	-	-
Diocetyl Phthalate, di-(2-ethylhexyl) phthalate	Light Colored Liquid	1	1	-	1	X	X	X	X	X	X	1	X	2	-	-	1	1	1	1	1	X
Diocetyl Sebacate, di-(2-ethylhexyl) sebacate	Pale Straw Colored Liquid	1	1	-	1	-	X	X	X	X	2	1	X	X	-	-	-	-	-	-	-	-
Diocetylamine di-(2-ethylhexyl)amine	Water White Liquid	1	-	-	-	-	-	-	-	-	-	-	-	-	-	-	-	-	-	-	-	-
DIOP (Diisooctyl Phthalate)	Nearly Colorless Liquid	1	-	-	-	1	X	-	X	-	1	X	X	-	-	-	-	-	-	-	-	-
Dioxane (Diethylene Dioxide)	Colorless Liquid	1	1	-	1	2	X	X	X	X	2	X	X	2	1	X	1	1	1	1	1	1
Dioxane (Diethylene Ether)	Colorless Liquid	1	1	-	1	2	X	X	X	X	2	X	X	2	1	X	1	1	1	1	1	1
Dioxolane (Ethylene Glycol Formal)	Water White Liquid	1	-	-	-	-	-	-	-	-	-	X	-	-	-	-	1	1	1	1	1	-

AGRICULTURE
AIR BREATHING
AIR DUCT
AIR AND MULTI-PURPOSE
CHEMICAL
FOOD AND BEVERAGE
MARINE AND ENGINE
MATERIAL HANDLING
MINING
OILFIELD
PETROLEUM
PRESSURE WASH AND WASHDOWN
STEAM
WATER
CLAMPS
COUPLINGS AND FERRULES
HOSE FINDER
CHEMICAL RESISTANCE TABLE

# Chemical Resistance Table

AGRICULTURE
AIR BREATHING
AIR DUCT
AIR AND MULTI-PURPOSE
CHEMICAL
FOOD AND BEVERAGE
MARINE AND ENGINE
MATERIAL HANDLING
MINING
OILFIELD
PETROLEUM
PRESSURE WASH AND WASHDOWN
STEAM
WATER
CLAMPS
COUPLINGS AND FERRULES
HOSE FINDER
CHEMICAL RESISTANCE TABLE

Contact Denver Product Application for recommendations for chemicals not listed.  
Phone (303) 744-5070

1 = Preferred - Constant Contact  
2 = Acceptable - Intermittent Contact  
X = Not Recommended  
- = No Data

NOTE: Ratings are for the effect on the polymer only!

Chemical	Form (at room temperature unless otherwise stated)	Gates Hose / Polymers																Couplings / Adapters				
		Chem Master™ Xtreme™ FEP	Chem Master™ Plus XLPE	Chem Master™ Plus UHMWPE	Food & Beverage Master																	
		T	K	L	S	P	C	D	D	A	H	V	M	J	Z	G	Iron/Carbon Steel	Stainless Steel 304	Stainless Steel 316	Aluminum	Brass	Polypropylene
		FEP	Gafron™	UHMWPE	Sanitron™	EPDM	NR	SBR	NR	Chloroprene	Butyl	Fluorocarbon	Hyprlon®	CPE	Nylon	PVC						
Dipentene (Cinene, Limonene)	Colorless Liquid	1	2	-	X	X	X	X	X	-	-	-	-	-	1	-	1	1	1	1	1	-
Diphenyl Phthalate	Yellow White Powder	1	1	-	1	-	-	-	-	-	-	1	-	-	-	-	-	-	-	-	-	-
Dipropyl Ketone	Colorless Liquid	1	1	-	1	1	-	-	-	-	-	X	-	-	-	-	-	-	-	-	-	-
Dipropylamine	Water White Liquid	1	1	-	-	-	-	-	-	-	-	-	-	-	-	-	-	-	-	-	-	-
Dipropylene Glycol	Colorless Liquid	1	1	1	1	1	-	-	-	-	-	1	-	-	-	-	-	-	-	-	-	-
Dipropylene Glycol Monomethyl Ether (DPM)	Colorless Liquid	1	1	1	1	1	-	-	-	-	-	-	-	-	-	-	-	-	-	-	-	-
Dirco Oils	Liquid	1	1	-	-	X	1	-	-	-	X	-	-	-	1	-	1	1	1	1	1	-
Disodium Phosphate (DSP soluble in H2O)	Colorless or White Powder	-	-	-	-	-	-	-	-	-	-	-	-	-	-	-	-	-	-	-	-	-
Disodium Phosphate Solution	In Water	1	1	1	1	1	-	-	-	-	-	1	-	-	-	-	-	-	-	-	-	-
Distillate Fuel Oil	Clear to Brown Liquid	1	2	-	X	X	-	-	-	-	-	1	-	-	-	-	-	-	-	-	-	-
Divinylbenzene (20-25% or 50-60% Grades)	Water White to Straw Liquid	1	2	-	X	X	X	X	X	-	X	1	-	-	-	-	-	-	-	-	-	-
DMA (Dimethylamine)	Gas	1	1	1	-	-	-	-	-	-	-	-	-	-	-	-	-	-	-	-	-	-
DMAC (Dimethyl Acetamide)	Colorless Liquid	1	1	-	-	-	-	-	-	-	-	-	-	-	-	-	-	-	-	-	-	-
DMB (Dimethylbenzene)	Colorless Liquid	1	X	X	X	X	X	X	X	X	X	1	X	X	X	X	-	-	-	-	-	-
DMF (Dimethylformamide)	Water White Liquid	1	2	-	-	-	-	-	-	-	-	X	-	-	-	-	1	1	1	-	-	1
DMP (Dimethylaminomethyl phenol)	Dark Red Liquid	1	1	-	-	-	-	-	-	-	-	1	-	-	-	-	-	-	-	-	-	-
Dodecylbenzene (Detergent Alkylate)	Liquid	1	2	-	X	X	-	-	-	-	-	1	-	-	-	-	-	-	-	-	-	-
Dodecylphenol	Straw Colored Liquid	1	1	-	1	1	-	-	-	-	-	1	-	-	-	-	-	-	-	-	-	-
Dolomite	Gray, Pink or White Powder	-	-	-	-	2	1	-	-	1	-	1	1	-	-	-	-	-	-	-	-	-
Dowtherm A (Biphenyl and Biphenyl Ether Mix.)	Liquid	1	1	-	1	1	X	X	X	X	X	1	X	X	-	X	1	1	1	1	1	-
Dowtherm SR-1 (Ethylene Glycol)	Liquid	1	1	1	1	1	1	-	-	-	1	1	-	1	-	-	2	1	1	1	1	1
DPM (Dipropylene Glycol Monomethyl Ether)	Colorless Liquid	1	1	1	1	1	-	-	-	-	-	-	-	-	-	-	-	-	-	-	-	-
Duro Oils	Liquid	1	1	-	-	X	1	-	-	-	X	-	-	-	1	2	1	1	1	1	1	-
<b>E</b>																						
EDB (Ethylene Dibromide)	Colorless Liquid	1	-	-	-	-	-	-	-	-	-	-	-	-	-	X	-	-	-	-	-	-
EDTA (Ethylenediaminetetraacetic Acid)	Colorless Crystals	1	1	-	-	1	-	-	-	-	-	1	-	-	-	-	-	-	-	-	-	-
Emulsion (Oil in Water)	Water is Continuous Phase	1	1	1	1	1	-	-	-	-	-	1	-	-	-	-	-	-	-	-	-	-
Enamels	Liquid	1	1	-	X	X	-	-	-	-	-	1	-	-	1	2	-	-	-	-	1	-
Epichlorohydrin (Chloropropylene Oxide)	Volatile Liquid	1	2	-	X	X	-	-	-	-	-	X	-	-	-	-	1	-	-	-	-	1
Epoxy Resin	Solid Pellet	-	-	-	-	1	-	-	-	1	2	X	-	-	-	-	-	-	-	-	-	-
Essential Oils	Liquid	1	2	-	X	X	1	X	X	2	-	1	-	-	-	2	1	1	1	1	1	-
Ethanol (Ethyl Alcohol)	Colorless Liquid	1	1	1	1	1	1	1	1	1	1	1	1	1	1	2	1	1	1	1	1	2
Ethanolamine (Aminoethanol)	Colorless Viscous Liquid	1	2	1	1	2	2	2	2	2	2	X	X	1	1	2	1	1	1	1	-	-
Ethers	Liquids	1	1	X	1	1	2	X	X	X	2	X	2	1	-	2	1	1	1	1	1	2
Ethyl Acetate (Acetic Ether)	Colorless Liquid	1	1	1	2	2	X	X	X	X	2	X	X	2	1	X	1	1	1	1	1	2
Ethyl Acetoacetate	Colorless Liquid	1	1	-	-	2	X	X	X	X	2	X	X	1	-	-	1	1	1	1	1	X
Ethyl Acrylate	Colorless Liquid	1	2	-	2	2	X	X	X	X	X	X	2	-	X	1	1	1	-	-	-	X
Ethyl Acrylate, Inhibited	Colorless Liquid	1	2	-	2	2	X	X	X	X	X	X	2	-	X	1	1	1	-	-	-	X
Ethyl Alcohol (Ethanol)	Colorless Liquid	1	1	1	1	1	1	1	1	1	1	1	1	1	1	2	1	1	1	1	2	1
Ethyl Aluminum Dichloride (Above 90°F/32°C)	Clear Yellow Liquid	1	-	-	-	X	-	X	-	X	2	X	-	-	-	-	-	-	-	-	-	-
Ethyl Bromide	Colorless Liquid	1	2	-	-	X	X	X	X	X	1	X	2	1	X	-	1	1	1	-	1	-
Ethyl Butyl Ether (Butyl Ethyl Ether)	Liquid	1	-	-	-	2	-	X	-	X	-	2	-	-	-	-	-	-	-	-	-	-
Ethyl Butyrate	Colorless Liquid	1	1	-	-	-	X	X	X	X	2	-	-	-	-	-	1	1	1	-	-	-
Ethyl Chloride	Compressed Liquid	1	2	2	-	X	X	X	X	X	1	X	X	-	X	2	1	1	1	1	2	X
Ethyl Chloroformate (Ethyl Chlorocarbonate)	Water White Liquid	1	-	-	-	X	X	-	-	-	-	1	-	-	-	-	-	-	-	-	-	-
Ethyl Ether (Diethyl Ether)	Colorless Liquid	1	2	X	1	X	X	X	X	X	2	X	X	1	2	X	2	1	1	1	1	1
Ethyl Ether Acetate (Cellosolve Acetate)	Colorless Liquid	1	1	-	-	2	X	-	-	-	-	X	-	1	-	1	1	1	-	-	1	-
Ethyl Formate	Water White Liquid	1	-	-	-	2	X	-	-	-	-	1	-	1	-	-	-	-	-	-	-	-

# Chemical Resistance Table

Contact Denver Product Application for recommendations for chemicals not listed.  
Phone (303) 744-5070

- 1 = Preferred - Constant Contact
- 2 = Acceptable - Intermittent Contact
- X = Not Recommended
- = No Data

NOTE: Ratings are for the effect on the polymer only!

Chemical	Form (at room temperature unless otherwise stated)	Gates Hose / Polymers														Couplings / Adapters						
		Chem Master™ Xtreme™ FEP	Chem Master™ Plus XLPE	Chem Master™ Plus UHMWPE	Food & Beverage Master																	
		T	K	L	S	P	C	D	D	A	H	V	M	J	Z	G	Iron/Carbon Steel	Stainless Steel 304	Stainless Steel 316	Aluminum	Brass	Polypropylene
Ethyl Iodide	Colorless Liquid	1	-	-	-	X	X	-	X	X	X	2	X	X	-	-	-	-	-	-	-	-
Ethyl Isobutyrate	Colorless Liquid	1	-	-	-	X	X	X	X	X	X	-	-	-	-	-	-	-	-	-	-	-
Ethyl Mercaptan (Ethanethiol)	Colorless Pungent Liquid	1	1	-	-	X	X	X	X	X	X	1	X	-	-	X	2	-	-	-	-	-
Ethyl Methyl Ketone (MEK)	Colorless Liquid	1	1	1	1	2	X	-	-	X	-	X	X	2	1	X	-	-	-	-	-	-
Ethyl Oleate	Light Yellowish Liquid	1	-	-	-	-	-	-	-	-	-	-	-	-	-	-	-	-	-	-	-	-
Ethyl Oxalate	Colorless Liquid	1	1	-	-	2	X	2	2	X	2	1	-	1	-	-	-	-	-	-	-	-
Ethyl Pentachlorobenzene	-	1	1	-	-	X	X	X	X	X	X	1	X	-	-	-	2	1	1	-	1	-
Ethyl Phthalate (Diethyl phthalate)	Water White Liquid	1	1	-	-	-	X	X	X	-	2	-	-	2	-	-	-	1	1	-	1	-
Ethyl Propionate	Water White Liquid	1	-	-	-	X	X	-	X	X	X	-	-	-	-	-	-	-	-	-	-	-
Ethyl Propyl Ketone (3-Hexanone)	Colorless Liquid	1	-	-	-	-	X	-	X	-	2	X	X	-	-	-	-	-	-	-	-	-
Ethyl Silicate	Colorless Liquid	1	1	-	-	2	1	2	2	1	-	1	-	1	-	-	1	1	1	1	1	-
Ethyl Sulfide (Diethyl Sulfide)	Colorless Oily Liquid	1	1	-	-	-	-	-	-	-	-	1	-	-	-	-	-	-	-	-	-	-
Ethylamine	Colorless Liquid or Gas	1	2	-	1	1	X	X	X	X	2	X	X	1	-	-	-	1	1	-	1	-
Ethylbenzene	Colorless Liquid	1	2	-	-	X	X	X	X	X	X	1	X	2	-	-	1	1	1	-	1	-
Ethylbutanol (2-Ethylbutyl Alcohol)	Colorless Liquid	1	1	1	1	1	1	-	-	1	1	1	2	1	1	1	-	-	-	-	-	-
Ethylbutyl Alcohol (Ethylbutanol)	Colorless Liquid	1	1	1	1	1	1	-	-	1	1	1	2	1	1	1	-	-	-	-	-	-
Ethylbutyl Amine	Water White Liquid	1	1	-	-	-	-	-	-	-	-	-	-	-	-	-	-	-	-	-	-	-
Ethylbutyl Ketone	Clear Liquid	1	1	-	-	1	-	-	-	-	-	X	-	-	-	-	-	-	-	-	-	-
Ethylbutyraldehyde (Diethylacetaldehyde)	Colorless Liquid	1	1	-	-	-	-	-	-	-	-	-	-	-	-	-	-	-	-	-	-	-
Ethylcellulose Granular Solid	Granular Solid	1	1	-	-	-	-	-	1	-	-	-	-	1	-	-	1	1	1	-	1	-
Ethylene Chlorohydrin	Colorless Liquid	1	1	-	2	X	X	-	-	X	2	1	-	-	X	X	-	-	-	-	-	-
Ethylene Cyanohydrin	Straw Colored Liquid	1	-	-	-	-	-	-	-	-	-	-	-	-	-	-	-	-	-	-	-	-
Ethylene Dibromide (EDB)	Colorless Liquid	1	-	-	-	-	-	-	-	-	-	-	-	-	-	X	-	-	-	-	-	-
Ethylene Dichloride (Chloroethane)	Colorless Liquid	1	2	2	X	X	X	X	X	X	2	X	X	X	X	X	-	-	-	-	-	-
Ethylene Glycol	Colorless Liquid	1	1	1	1	1	1	-	-	1	1	1	2	1	-	1	2	1	1	1	1	1
Ethylene Glycol Formal (Dioxolane)	Water White Liquid	1	-	-	-	-	-	-	-	-	-	X	-	-	-	-	1	1	1	1	1	-
Ethylene Glycol Monoethylether	Colorless Liquid	1	1	-	1	1	X	-	-	-	-	-	-	-	-	-	-	-	-	-	-	-
Ethylene Glycol Monoethylether Acetate	Colorless Liquid	1	1	-	1	1	X	-	-	-	-	-	-	-	-	-	-	-	-	-	-	-
Ethylene Glycol Monomethyl Ether	Colorless Liquid	1	1	-	1	2	X	-	-	-	-	-	-	-	-	-	-	-	-	-	-	-
Ethylene Glycol N-Butyl Ether	Colorless Liquid	1	1	-	1	1	X	-	-	-	-	-	-	-	-	-	-	-	-	-	-	-
Ethylenediamine	Colorless Liquid	1	2	-	-	2	1	-	-	-	2	X	-	-	-	-	1	1	-	-	1	1
Ethylenediaminetetraacetic acid (EDTA)	Colorless Crystals	1	1	-	-	1	-	-	-	-	-	1	-	-	-	-	-	-	-	-	-	-
Ethylhexaldehyde	Colorless Liquid	1	1	-	-	-	-	-	-	-	-	-	-	-	-	-	-	-	-	-	-	-
Ethylhexanediol	Colorless Liquid	1	1	-	-	2	-	-	-	-	-	-	-	-	-	-	-	-	-	-	-	-
Ethylhexanol (2-ethylhexyl alcohol)	Colorless Liquid	1	1	1	1	1	1	1	1	-	1	1	-	1	1	1	-	-	-	-	-	-
Ethylhexoic Acid	Liquid	1	1	1	-	2	-	-	-	-	-	-	-	-	-	-	-	-	-	-	-	-
Ethylhexyl Acetate	Water White Liquid	1	1	-	-	1	X	-	-	X	-	X	X	-	1	-	-	-	-	-	-	-
Ethylhexyl Acrylate	Liquid	1	2	-	2	-	X	-	-	-	-	X	-	-	-	X	-	-	-	-	-	-
Ethylhexyl Alcohol (Ethylhexanol)	Colorless Liquid	1	1	1	1	1	1	1	1	-	1	1	-	1	1	1	-	-	-	-	-	-
<b>F</b>																						
Fatty Acid	Solid, Semisolid or Liquid	1	2	2	2	2	2	X	X	2	2	2	X	2	-	2	2	1	1	1	2	1
Fatty Alcohol, Blend	C8-11 Liquids, > C11 Solids	1	1	1	1	1	1	1	1	1	1	1	-	1	1	1	-	-	-	-	-	-
Fatty Petroleum Alcohol	C11 or Less are Liquids	1	1	1	1	1	1	-	-	-	1	1	-	1	1	-	-	-	-	-	-	-
Ferric Bromide	Red Crystals	-	-	-	-	-	-	-	1	-	-	-	-	-	-	-	-	-	-	-	-	-
Ferric Chloride	Black-Brown Solid	1	1	-	-	-	2	-	1	2	1	1	2	1	1	1	X	X	X	X	X	1
Ferric Chloride Solution	Liquid	1	1	-	-	-	2	-	1	2	1	1	2	1	1	1	X	X	X	X	X	1
Ferric Nitrate	Violet Crystals	1	1	-	-	-	2	1	2	2	-	2	1	-	-	X	1	1	-	-	1	1
Ferric Nitrate Solution	Liquid	1	-	-	-	1	1	-	1	1	1	1	1	-	1	-	X	1	1	-	-	1

AGRICULTURE
AIR BREATHING
AIR DUCT
AIR AND MULTI-PURPOSE
CHEMICAL
FOOD AND BEVERAGE
MARINE AND ENGINE
MATERIAL HANDLING
MINING
OILFIELD
PETROLEUM
PRESSURE WASH AND WASHDOWN
STEAM
WATER
CLAMPS
COUPLINGS AND FERRULES
HOSE FINDER
CHEMICAL RESISTANCE TABLE

## Chemical Resistance Table

Application Category	Contact Denver Product Application for recommendations for chemicals not listed. Phone (303) 744-5070  1 = Preferred - Constant Contact 2 = Acceptable - Intermittent Contact X = Not Recommended - = No Data  NOTE: Ratings are for the effect on the polymer only!		Gates Hose / Polymers														Couplings / Adapters						
			Chem Master™ Xtreme™ FFP	Chem Master™ Plus XLPE	Chem Master™ Plus UHMWPE	Sanitron™ Food & Beverage Master	EPDM	NR	SBR	NR	Chloroprene	Butyl	Fluorocarbon	Hypalon®	CPE	Nylon	PVC	Iron/Carbon Steel	Stainless Steel 304	Stainless Steel 316	Aluminum	Brass	Polypropylene
			T	K	L	S	P	C	D	D	A	H	V	M	J	Z	G						
Chemical	Form (at room temperature unless otherwise stated)	FFP	Galtron™	UHMWPE	Sanitron™	EPDM	NR	SBR	NR	Chloroprene	Butyl	Fluorocarbon	Hypalon®	CPE	Nylon	PVC	Iron/Carbon Steel	Stainless Steel 304	Stainless Steel 316	Aluminum	Brass	Polypropylene	
AGRICULTURE																							
AIR BREATHING																							
AIR DUCT																							
AIR AND MULTI-PURPOSE																							
CHEMICAL	Ferric Sulfate	Yellow Crystals or Gray Powder	-	-	-	-	-	-	-	1	-	-	-	-	-	-	X	1	1	X	X	1	
	Ferric Sulfate Solution	Liquid	1	1	1	-	2	2	2	-	2	2	1	2	1	-	1	X	1	1	X	X	1
	Ferrous Acetate Solution	Liquid in H2O or Alcohol	1	1	-	-	-	-	-	-	-	-	1	-	-	-	-	-	-	-	-	-	-
FOOD AND BEVERAGE	Ferrous Chloride	Greenish-White Crystals	-	-	-	-	-	-	1	-	-	-	-	-	-	-	X	1	2	-	2	1	
	Ferrous Chloride, Solution	Liquid	1	1	-	-	-	-	-	1	1	2	1	-	1	X	1	2	-	2	1	1	
	Ferrous Nitrate	-	1	1	-	2	2	-	2	2	-	2	-	2	-	2	-	1	1	-	-	1	
	Ferrous Sulfate Solution	Liquid	1	1	1	-	2	2	2	-	2	2	1	2	1	-	1	X	1	1	X	X	1
MARINE AND ENGINE	Fertilizer (Liquid Manure)	Liquid	1	1	1	1	1	1	1	1	1	1	1	-	1	2	1	1	1	1	1	1	
	Finishing Oil	Liquid	1	-	1	-	-	-	-	-	-	-	-	-	-	-	-	-	-	-	-	-	
	Fire-Resistant Hydra-Fluid (Texaco)	Liquid	1	1	-	-	X	1	-	-	-	X	-	-	-	-	-	1	1	1	1	1	
	Firtec 290, MF	Liquid	1	1	-	-	-	-	-	-	-	-	-	-	-	-	-	-	-	-	-	-	
MATERIAL HANDLING	Fish Oil	Liquid	1	-	1	X	X	1	-	-	2	-	1	-	-	-	-	-	-	-	-	-	
	Fixing Solution (Photo)	Liquid	1	1	-	-	-	2	2	2	2	-	2	-	1	1	-	1	1	-	-	1	
	Flint	Gray, Brownish, Black	-	-	-	-	-	-	1	-	-	-	-	-	-	-	-	-	-	-	-	-	
MINING	Floor Wax (Temperature Dependent)	Varies	1	-	1	-	-	-	-	-	-	-	-	-	-	-	-	-	-	-	-	-	
	Fluoboric Acid (48% Purity)	Colorless Liquid	1	1	1	1	2	-	2	2	2	-	2	1	-	X	-	1	1	-	-	1	
	Fluoboric Acid (up to 48%)	Colorless Liquid	1	1	-	1	-	2	2	2	-	1	2	1	-	X	-	1	1	-	-	1	
OILFIELD	Fluorine	Pale Yellow Gas	X	-	X	-	X	-	-	-	-	1	-	-	X	1	-	-	-	-	-	-	
	Fluorine (Liquid)	Yellow Liquid	NO HOSE AVAILABLE																				
	Fluosilicic Acid (50%)	Colorless Liquid	1	1	1	1	2	X	-	2	X	-	2	1	X	X	-	-	-	1	-	1	
PETROLEUM	Formaldehyde	Gas	-	1	-	-	1	-	-	-	-	1	-	-	1	-	X	2	1	2	1	-	
	Formaldehyde Solution (up to 50%)	Liquid	1	2	1	1	1	2	X	X	2	2	1	2	1	1	1	X	2	1	2	1	
	Formalin (37-50% HCHO with 15% MeOH)	Liquid	1	1	-	1	1	2	X	X	2	2	1	2	1	1	1	-	-	-	-	-	
	Formamide	Colorless Oily Liquid	1	1	-	-	-	X	X	-	-	-	-	-	X	-	-	-	-	-	-	-	
PRESSURE WASH AND WASHDOWN	Formic Acid	Colorless Liquid (bp 100°C)	1	1	1	1	2	-	X	X	1	2	X	2	1	X	X	X	2	1	-	2	
	FR Fluid D	Liquid	1	1	-	-	X	1	-	-	-	X	-	-	-	-	-	-	-	-	-	-	
	FR Hydraulic Fluid	Brown Liquid	1	1	-	-	-	1	-	-	-	-	-	-	-	-	-	-	-	-	-	-	
STEAM	Freon 12 (Dichlorodifluoromethane)	Gas or Liquid	SPECIAL HOSE REQUIRED																				
	Freon 13	Gas or Liquid	SPECIAL HOSE REQUIRED																				
	Freon 134a (HFC 134a)	Gas or Liquid	SPECIAL HOSE REQUIRED																				
	Freon 22 (Chlorodifluoromethane)	Gas or Liquid	SPECIAL HOSE REQUIRED																				
	Freon 23	Clear Liquid	SPECIAL HOSE REQUIRED																				
WATER	Fruit Juices	Liquid	-	-	-	1	-	-	-	-	-	-	-	-	-	1	-	-	-	-	-	-	
CLAMPS	Fuel Oil (ASTM 1-6)	Water White to Brown Liquids	1	2	1	X	X	1	X	X	2	X	1	X	1	1	X	2	2	2	1	1	-
	Fumaric Acid	Colorless Crystals	1	1	1	1	2	-	2	2	-	1	-	-	-	X	-	1	1	-	-	-	
	Fumaric Acid Solution (Allomalaic Acid)	Liquid	1	1	-	-	2	1	2	2	-	1	-	-	-	X	-	1	1	-	-	-	
COUPLINGS AND FERRULES	Furan (Furfuran)	Colorless to Brown Liquid	1	1	1	-	X	X	X	X	X	-	-	1	-	X	1	1	1	1	1	1	
	Furfural (Ant Oil)	Colorless to Reddish Brown Liquid	1	1	-	2	X	X	X	X	2	X	2	2	1	-	X	2	1	1	1	1	
	Furfural Alcohol	Colorless to Brown Liquid	1	1	2	2	X	X	X	X	2	X	1	2	1	1	X	2	1	1	1	1	
	Furfuran (Furan)	Colorless to Brown Liquid	1	1	1	-	X	X	X	X	X	-	-	1	-	X	1	1	1	1	1	1	
	Furfuryl Alcohol	Colorless to Reddish Brown Liquid	1	1	-	2	-	-	-	-	-	-	1	-	-	1	-	-	-	-	-	-	
HOSE FINDER	Fusel Oil (Amyl Alcohol, Grain Oil)	Colorless Liquid	1	1	1	1	2	2	2	2	2	2	1	2	1	1	1	1	1	1	1	1	
	Fyrguard 150, 200	-	1	1	-	-	1	1	-	-	-	1	-	-	-	-	-	1	1	1	1	1	
	Fyrquel 15R&O, 220R&O, 550R&O	-	1	1	-	-	1	X	-	-	-	1	-	-	-	-	-	1	-	-	1	-	
	Fyrquel 90, 150, 220, 300, 550, 1000	-	1	1	-	-	1	X	-	-	-	1	-	-	-	-	-	1	-	-	1	-	
CHEMICAL RESISTANCE TABLE	<b>6</b>																						
	Gallic Acid (3,4,5 Trihydroxybenzoic Acid)	In Alcohol or Glycerol	1	1	1	1	1	X	2	2	X	2	1	-	1	X	X	X	1	1	-	-	1
	Gallic Acid Solution	In Alcohol Solution	1	1	-	1	-	X	2	2	X	2	1	-	1	X	X	X	1	1	-	-	1

# Chemical Resistance Table

Contact Denver Product Application for recommendations for chemicals not listed.  
Phone (303) 744-5070

1 = Preferred - Constant Contact  
2 = Acceptable - Intermittent Contact  
X = Not Recommended  
- = No Data

NOTE: Ratings are for the effect on the polymer only!

Chemical	Form (at room temperature unless otherwise stated)	Gates Hose / Polymers																Couplings / Adapters					
		Chem Master™ Xtreme™ FEP		Chem Master™ Plus XLPE		Chem Master™ Plus UHMWPE		Sanitron™ Food & Beverage Master															
		T	K	L	S	P	C	D	D	A	H	V	M	J	Z	G	Iron/Carbon Steel	Stainless Steel 304	Stainless Steel 316	Aluminum	Brass	Polypropylene	
FEP	Galtron™	UHMWPE	Sanitron™	EPDM	NRB	SBR	NR	Chloroprene	Butyl	Fluorocarbon	Hypalon®	CPE	Nylon	PVC	Iron/Carbon Steel	Stainless Steel 304	Stainless Steel 316	Aluminum	Brass	Polypropylene			
Gasohol (Gasoline blended with Ethanol) <sup>1</sup>	Colorless Liquid	1	2	1	X	X	2	X	X	2	X	1	X	-	1	X	2	1	1	1	1	X	
Gasoline (Oxygenated-Blended With MTBE) <sup>1</sup>	Colorless Liquid	1	2	1	X	X	2	X	X	2	X	1	X	-	1	X	2	1	1	1	1	X	
Gasoline (Unleaded Up to 50% Aromatics) <sup>1</sup>	Colorless Liquid	1	2	1	X	X	2	X	X	2	X	1	X	1	1	X	2	1	1	1	1	-	
Gasoline (White) <sup>1</sup>	Colorless Liquid	1	2	-	X	X	2	X	X	2	X	1	X	-	1	X	2	1	1	1	1	-	
Gelatin	Flakes or Powder	-	-	-	-	-	-	1	-	-	-	-	-	1	1	-	-	-	-	-	-	-	
Glacial Acetic Acid	Clear Colorless Liquid	1	1	1	X	2	-	-	-	X	X	X	-	X	X	X	-	-	-	-	-	-	
Glacial Methacrylic Acid (GMAA)	White Crystals	1	-	-	-	-	-	-	-	-	-	-	-	-	-	-	-	-	-	-	-	-	
Glauber's Salt (Sodium Sulfate Decahydrate)	Crystals or Powder	1	-	-	-	1	-	1	1	-	-	-	-	-	-	-	-	-	-	-	-	-	
Gluconic Acid (Commercial 50% Aqueous)	Aqueous Solution	1	-	-	-	-	X	-	X	-	X	-	2	1	-	-	-	-	-	-	-	-	
Glucose	Crystals to White Powder	-	-	-	-	-	-	1	-	-	-	-	-	-	-	1	1	1	1	1	1	-	
Glucose Solution	Liquid	1	1	-	1	1	1	1	1	1	1	1	-	-	1	1	1	1	1	1	1	-	
Glue	Varies	1	1	-	-	X	2	X	X	2	X	1	1	-	2	1	2	1	1	1	1	X	
Glycerine (Glycerol)	Clear Viscous Liquid	1	1	-	1	1	1	1	1	1	1	1	1	-	1	2	1	1	1	1	1	-	
Glycerol (Glycerine)	Clear Viscous Liquid	1	1	-	1	1	1	1	1	1	1	1	1	-	1	2	1	1	1	1	1	-	
Glycerol Monolaurate	Liquid above 80°F (27°C)	1	1	1	1	1	-	-	-	1	1	-	-	-	-	-	-	-	-	-	-	-	
Glycol FR Fluids	Liquid	1	-	-	1	1	-	-	1	-	-	-	-	-	-	-	-	-	-	-	-	-	
Glycol Slurry	Watery Suspension	1	-	2	-	-	-	-	-	-	-	-	-	-	-	-	-	-	-	-	-	-	
Glycols (ie Ethylene Glycol)	Clear Colorless Liquid	1	1	1	1	1	1	1	1	1	1	1	1	1	-	1	1	1	1	1	1	-	
GMAA (Glacial Methacrylic Acid)	White Crystals	1	-	-	-	-	-	-	-	-	-	-	-	-	-	-	-	-	-	-	-	-	
Graphite	Powdered, Flake, Crystals	1	-	1	-	-	-	1	-	-	-	-	-	-	-	-	-	-	-	-	-	-	
Grease	Semi-Solid	1	1	2	2	X	1	X	X	2	X	1	2	-	-	1	1	1	1	1	1	-	
Grease, Silicone Base	-	1	-	1	-	-	-	-	-	-	-	-	-	1	-	1	1	1	1	1	1	-	
Green Liquor (Effluent Alkaline Pulping)	Liquid	1	1	1	-	-	-	-	-	-	-	-	-	-	1	-	-	-	-	-	-	-	
Green Sulfate Liquor	Liquid	1	1	1	-	1	2	1	1	1	1	-	1	2	-	-	1	1	1	-	-	-	
<b>H</b>																							
Halowax (Chlorinated Hydrocarbons)	Oils to Waxy Solid	1	1	1	-	X	X	X	X	X	1	X	-	-	-	-	-	-	-	-	-	-	
HEA (2-Hydroxyethyl Acrylate)	Liquid	1	1	1	1	X	-	-	-	-	1	1	-	-	-	-	-	-	-	-	-	-	
HEA Acid (2-Hydroxyethyl Acrylate)	Liquid	1	1	1	1	X	-	-	-	-	1	-	1	-	-	-	-	-	-	-	-	-	
Hematite (Iron Ore)	Black to Brick Red	1	-	-	-	-	-	1	-	-	-	-	-	-	-	-	-	-	-	-	-	-	
HEP (2-Hydroxypropyl Acrylate)	Liquid	1	1	1	1	X	-	-	-	-	1	-	1	-	-	-	-	-	-	-	-	-	
Heptachlor (In Xylene)	Liquid	1	2	-	X	X	2	X	X	X	1	-	-	1	X	-	-	-	-	-	-	-	
Heptanal (Heptaldehyde)	Colorless Oily Liquid	1	-	-	-	-	-	-	-	-	-	-	-	-	-	-	-	-	-	-	-	-	
Heptane	Colorless Liquid	1	2	1	X	X	1	X	X	2	X	1	X	1	1	2	1	1	1	1	1	-	
Heptanedicarboxylic Acid (Azelaic Acid)	Yellowish to White Powder	1	-	-	-	-	-	1	-	-	-	-	-	-	-	-	-	-	-	-	-	-	
Heptanoic Acid	Clear Oily Liquid	1	1	1	-	-	-	-	-	-	1	-	-	-	-	-	-	-	-	-	-	-	
Heptanol	Colorless Liquid	1	1	1	1	1	1	1	1	1	1	1	1	X	1	1	-	-	-	-	-	-	
Hexachlorocyclohexane	White to Yellowish Flakes	-	-	-	-	-	-	1	-	-	-	-	-	-	-	-	-	-	-	-	-	-	
Hexachlorocyclopentadiene	Yellow Liquid	1	-	-	X	X	-	X	X	-	X	1	-	-	-	-	-	-	-	-	-	-	
Hexadecanoic Acid (Palmitic Acid)	White Crystals	-	-	-	-	-	-	1	-	-	-	-	-	-	-	-	-	-	-	-	-	-	
Hexahydrophthalic Anhydride	Clear Colorless Viscous Liquid	1	-	-	-	-	-	-	-	-	-	-	-	-	-	-	-	-	-	-	-	-	
Hexaldehyde	Colorless Liquid	1	1	1	1	1	-	-	-	-	-	-	-	-	-	1	1	1	1	1	1	-	
Hexamethylenediamine, Solution	Colorless Flat Solid Leaflets	-	-	-	-	-	-	1	-	-	-	-	-	-	-	-	-	-	-	-	-	-	
Hexamethyleneimine	Clear Colorless Liquid	1	-	-	-	-	-	-	-	-	-	-	-	-	-	-	-	-	-	-	-	-	
Hexane	Colorless Liquid	1	X	1	X	X	1	X	X	-	X	1	-	1	1	X	1	1	1	-	1	-	
Hexanol (Hexyl Alcohol)	Colorless Liquid	1	1	-	-	X	1	-	-	2	-	1	X	1	-	-	1	1	1	1	2	-	
Hexanone (Ethyl Propyl Ketone)	Colorless Liquid	1	-	-	-	X	-	X	-	2	X	X	-	-	-	-	-	-	-	-	-	-	
Hexene	Colorless Liquid	1	-	-	X	X	2	X	X	-	X	1	-	1	-	-	1	1	1	-	1	-	
Hexyl "Cellulosolve" (EG monoethyl ether)	Water White Liquid	1	1	1	-	-	-	-	-	-	1	-	-	-	-	-	-	-	-	-	-	-	

<sup>1</sup> Only use fuel rated hose, except for transfer.

- AGRICULTURE
- AIR BREATHING
- AIR DUCT
- AIR AND MULTI-PURPOSE
- CHEMICAL
- FOOD AND BEVERAGE
- MARINE AND ENGINE
- MATERIAL HANDLING
- MINING
- OILFIELD
- PETROLEUM
- PRESSURE WASH AND WASHDOWN
- STEAM
- WATER
- CLAMPS
- COUPLINGS AND FERRULES
- HOSE FINDER
- CHEMICAL RESISTANCE TABLE



# Chemical Resistance Table

AGRICULTURE
AIR BREATHING
AIR DUCT
AIR AND MULTI-PURPOSE
CHEMICAL
FOOD AND BEVERAGE
MARINE AND ENGINE
MATERIAL HANDLING
MINING
OILFIELD
PETROLEUM
PRESSURE WASH AND WASHDOWN
STEAM
WATER
CLAMPS
COUPLINGS AND FERRULES
HOSE FINDER
CHEMICAL RESISTANCE TABLE

Contact Denver Product Application for recommendations for chemicals not listed.  
Phone (303) 744-5070

1 = Preferred - Constant Contact  
2 = Acceptable - Intermittent Contact  
X = Not Recommended  
- = No Data

NOTE: Ratings are for the effect on the polymer only!

Chemical	Form (at room temperature unless otherwise stated)	Gates Hose / Polymers														Couplings / Adapters						
		Chem Master™ Xtreme™ FEP	Chem Master™ Plus XLPE	Chem Master™ Plus UHMWPE	Food & Beverage Master																	
		T	K	L	S	P	C	D	D	A	H	V	M	J	Z	G	Iron/Carbon Steel	Stainless Steel 304	Stainless Steel 316	Aluminum	Brass	Polypropylene
		FEP	Gafron™	UHMWPE	Sanitron™	EPDM	NR	SBR	NR	Chloroprene	Butyl	Fluorocarbon	Hydralon®	CPE	Nylon	PVC						
Hexyl Alcohol (Hexanol)	Colorless Liquid	1	1	-	-	X	1	-	-	2	-	1	X	1	-	-	1	1	1	1	2	-
Hexyl Methacrylate	Liquid	1	-	-	-	-	-	-	-	-	-	-	-	-	-	-	-	-	-	-	-	-
Hexylamine	Water White Liquid	1	-	-	-	-	X	-	X	-	2	X	X	-	-	-	-	-	-	-	-	-
Hexylene (1-Hexene)	Colorless Liquid	1	-	-	X	X	2	X	X	-	X	1	-	1	-	-	1	1	1	-	1	-
Hexylene Glycol	Colorless Liquid	1	1	1	1	1	-	-	-	-	-	1	-	1	-	-	-	-	-	-	-	-
Honey	Yellow Liquid	1	-	-	-	1	1	-	1	1	-	1	-	-	-	1	-	-	-	-	-	-
Houghto-Safe 1055, 1110, 1115, 1120, 1130	Liquid	1	1	-	-	1	X	-	-	-	1	-	-	-	-	-	1	1	1	1	1	-
Houghto-Safe 271, 416, 520 & 616, 620	Liquid	1	1	-	-	1	1	-	-	-	1	-	-	-	-	-	1	1	1	1	1	-
Houghto-Safe 5046	Liquid	1	1	-	-	X	1	-	-	-	X	-	-	-	-	-	1	1	1	1	1	-
Houghto-Safe 625, 640 & 525 (Under 100°F/38°C)	Liquid	1	1	-	-	1	1	-	-	-	1	-	-	-	-	-	1	1	1	1	1	-
HPA Acid (2-Hydroxypropyl Acrylate)	Liquid	1	1	1	1	X	-	-	-	-	-	1	-	1	-	-	-	-	-	-	-	-
HPO (Sodium Thiosulfate)	White Powder	1	1	-	-	-	1	1	1	1	1	-	1	1	1	1	X	1	1	2	X	-
Hy-Chock Oil	Liquid	1	1	-	-	-	1	-	-	-	-	1	-	-	1	-	1	1	1	-	-	-
Hydrocyanic Acid (up to 98%)	Water White Liquid	1	X	-	-	-	-	-	-	-	-	1	-	-	-	-	X	1	1	1	X	-
Hydrauluid 760 (Texaco and Houghton)	Liquid	1	1	-	-	X	1	-	-	-	X	1	-	-	1	-	1	1	1	1	1	-
Hydrauluid AZR&O, A, B, AA, C	Liquid	1	1	-	-	X	1	-	-	-	X	1	-	-	1	-	1	1	1	1	1	-
Hydrasol A (Textile Dyeing)	-	1	1	-	-	X	1	-	-	-	X	1	-	-	1	-	1	1	1	1	1	-
Hydraulic Fluid (Phosphate Ester Base)	Liquid	1	1	-	-	1	X	-	-	X	1	1	-	-	1	1	1	1	1	-	-	-
Hydraulic Fluid (Polyalphaolfin)	Liquid	1	-	-	-	-	-	-	-	-	-	1	-	-	-	-	1	1	1	1	1	-
Hydraulic Fluid (Std. Petroleum Oils)	Liquid	1	1	-	-	X	1	X	X	2	X	1	2	1	1	1	1	1	1	1	1	-
Hydraulic Fluid (Water Glycol Base)	Liquid	1	1	-	-	-	1	2	2	1	1	1	-	-	1	1	1	1	1	1	1	-
Hydraulic Fluid HF-18, HF-20	Liquid	1	1	-	-	1	1	-	-	-	1	1	-	-	1	2	1	1	1	1	1	-
Hydraulic Fluid HF-31	Liquid	1	1	-	-	X	-	-	-	-	X	-	-	-	1	-	1	1	1	1	1	-
Hydrazine	Colorless Fuming Liquid	1	1	-	-	2	X	X	X	X	2	X	X	-	-	X	-	-	-	-	-	-
Hydrazine Hydrate	Colorless Fuming Liquid	1	1	-	-	2	X	X	X	X	2	X	X	-	-	X	-	-	-	-	-	-
Hydrazine Solution	Liquid	1	1	-	-	2	X	X	X	X	2	X	X	-	-	X	-	-	-	-	-	-
Hydro-Drive Oil (Houghton)	Liquid	1	-	-	-	X	1	-	-	-	X	-	-	-	-	2	-	-	-	-	-	-
Hydrobromic Acid (62% or less)	Colorless to Yellow Liquid	1	1	1	1	X	X	2	2	X	2	1	2	1	X	X	-	-	-	X	-	-
Hydrobromic Acid (to 48%)	Colorless to Yellow Liquid	1	1	1	1	1	X	2	2	X	2	1	2	1	X	X	-	-	-	X	-	-
Hydrochloric Acid (15%)	Colorless to Yellow Liquid	1	1	1	1	2	X	2	2	X	2	1	2	1	X	X	X	X	X	X	X	-
Hydrochloric Acid (37%)	Colorless to Yellow Liquid	1	1	1	1	X	X	2	2	X	2	1	2	1	X	X	X	X	X	X	X	-
Hydrochloric Acid, anhydrous	Colorless Fuming Gas	1	-	-	-	-	-	-	-	-	-	1	-	X	-	-	X	X	X	X	X	-
Hydrocyanic Acid (10% Solution with water)	Water White Liquid	1	1	1	-	-	X	2	2	X	-	1	2	X	-	X	X	1	1	1	X	-
Hydrocyanic Acid (98% or less)	Water White Liquid below 77°F (25°C)	1	-	-	-	-	-	-	-	-	-	1	-	X	-	X	-	-	-	-	-	-
Hydrocyanic Acid (up to 20%)	Water White Liquid	1	1	-	-	1	2	2	2	2	-	1	1	X	-	2	-	-	-	-	-	-
Hydrofluoric Acid (38% or less)	Colorless Liquid	1	1	1	1	2	X	X	X	2	2	1	1	1	X	X	X	X	X	X	X	-
Hydrofluoric Acid (47% or less)	Colorless Liquid	1	1	1	1	2	X	X	X	2	2	1	2	1	X	X	X	X	X	X	X	-
Hydrofluoric Acid (53% or less)	Colorless Liquid	1	1	X	1	-	X	X	X	2	X	1	2	1	X	X	X	X	X	X	X	-
Hydrofluoric Acid (70%)	Colorless Liquid	1	1	X	1	X	X	X	X	X	-	1	2	1	X	X	X	X	X	X	X	-
Hydrofluoric Acid (Concentrated)	Colorless Liquid	1	1	X	2	X	X	X	X	X	X	2	2	1	X	X	X	X	X	X	X	-
Hydrofluosilicic Acid	In Water	1	1	1	2	2	X	X	X	X	X	1	1	X	X	X	X	X	X	-	1	-
Hydrogen (Gas)	Gas	CONTACT DENVER PRODUCT APPLICATION																				
Hydrogen Bromide Liquefied (Anhydrous)	Liquid	1	-	-	-	1	X	X	X	-	X	1	-	X	-	-	-	-	-	-	-	-
Hydrogen Bromide Solution (Hydrobromic Acid)	Liquid	1	-	-	-	-	-	-	-	-	-	-	-	-	-	-	-	-	-	-	-	-
Hydrogen Bromide, Anhydride	Colorless Gas	1	-	-	-	-	-	-	-	-	-	-	-	-	-	-	-	-	-	-	-	-
Hydrogen Chloride	Colorless Fuming Gas	1	-	-	-	-	-	-	-	-	-	1	-	1	-	-	-	-	-	-	-	-
Hydrogen Dioxide (Hydrogen Peroxide)	Liquid	1	-	-	-	2	X	-	-	2	-	1	1	-	-	-	-	-	-	-	-	-

# Chemical Resistance Table

Contact Denver Product Application for recommendations for chemicals not listed.  
Phone (303) 744-5070

1 = Preferred - Constant Contact  
2 = Acceptable - Intermittent Contact  
X = Not Recommended  
- = No Data

NOTE: Ratings are for the effect on the polymer only!

Chemical	Form (at room temperature unless otherwise stated)	Gates Hose / Polymers														Couplings / Adapters					
		Chem Master™ Xtreme™ FEP	Chem Master™ Plus XLPE	Chem Master™ Plus UHMWPE	Food & Beverage Master																
		T	K	L	S	P	C	D	D	A	H	V	M	J	Z	G	Iron/Carbon Steel	Stainless Steel 304	Stainless Steel 316	Aluminum	Brass
FEP	Gartron™	UHMWPE	Sanitron™	EPDM	NR	SBR	NR	Chloroprene	Butyl	Fluorocarbon	Hydron®	CPE	Nylon	PVC	Iron/Carbon Steel	Stainless Steel 304	Stainless Steel 316	Aluminum	Brass	Polypropylene	
Hydrogen Fluoride	Colorless Gas or Liquid	1	-	-	1	X	X	X	-	2	X	-	-	-	-	1	1	1	-	-	-
Hydrogen Peroxide (35% or less)	Liquid	1	1	1	X	1	2	X	X	1	X	1	1	X	1	1	X	2	1	1	X
Hydrogen Peroxide (50% or less)	Liquid	1	2	1	X	1	2	X	X	1	X	1	1	X	2	2	X	2	1	1	X
Hydrogen Peroxide (70% or less)	Liquid	1	2	1	X	2	X	X	X	2	-	1	1	X	X	2	X	2	1	1	X
Hydrogen Peroxide (90% or less)	Liquid	1	-	1	-	2	X	X	X	2	-	1	1	X	X	X	X	2	1	1	X
Hydrogen Sulfide	Colorless Gas	NO HOSE AVAILABLE																			
Hydrogen Sulfide, Liquefied	Liquid @ 410 PSI, 120°F (49°C)	1	-	-	-	1	X	X	-	2	X	X	-	-	-	-	-	-	-	-	-
Hydrolube (Water Glycol)	Liquid	1	-	1	-	1	1	-	-	2	1	-	-	-	1	-	-	-	-	-	-
Hydrolubric Oil (Houghton)	Liquid	1	1	-	-	X	2	-	-	-	X	-	-	1	2	-	-	-	-	-	-
Hydroquinone	White Crystals	1	1	-	-	X	-	X	X	X	2	X	-	-	-	-	1	1	-	-	-
Hydroquinone Solution	Liquid	1	-	-	-	X	X	-	X	X	1	-	-	-	2	-	1	1	-	-	-
Hydroxyacetic Acid	Colorless Crystals	-	-	-	-	-	-	1	-	-	-	-	-	-	-	-	-	-	-	-	-
Hydroxyacetic Acid Solution	Liquid	1	1	1	1	2	-	-	-	-	-	-	-	-	-	-	-	-	-	-	-
Hydroxyethyl Acrylate (HEA)	Liquid	1	1	1	1	X	-	-	-	-	1	-	1	-	-	-	-	-	-	-	-
Hydroxyethyl Acrylate Acid (HEA Acid)	Liquid	1	1	1	1	X	-	-	-	-	1	-	1	-	-	-	-	-	-	-	-
Hydroxyethyl Methacrylate	Clear Liquid	1	-	-	-	-	-	-	-	-	1	-	-	-	-	-	-	-	-	-	-
Hydroxyethyl Methacrylate Solution in Xylene	Clear Liquid	1	2	-	-	-	-	-	-	-	1	-	-	-	-	-	-	-	-	-	-
Hydroxypropyl Acrylate Acid (HPA Acid)	Liquid	1	1	1	1	X	-	-	-	-	1	-	1	-	-	-	-	-	-	-	-
Hylene (Toluene Diisocyanate)	Yellow Liquid	1	-	-	-	2	X	X	X	X	2	X	X	-	-	-	-	-	-	-	-
Hypochlorous Acid (only in dilute solutions)	Greenish-Yellow Aqueous Sol.	1	1	1	1	2	X	X	X	X	1	2	-	-	-	-	-	-	-	-	-
I																					
Ink (Printers)	Liquid	1	1	-	-	X	2	X	X	-	X	X	-	1	-	2	2	1	-	2	-
Ink Oil	Liquid	1	2	-	-	2	-	-	-	-	-	-	-	-	-	1	1	1	-	1	-
Insulating Oil (Transformer) <sup>1</sup>	Liquid	1	1	-	-	X	1	X	X	2	X	1	X	-	-	1	1	1	-	1	-
Iodine	Grayish Black Granules	1	-	-	-	-	-	1	X	-	-	-	-	X	X	X	X	-	-	-	-
Iodine Solution	Liquid	1	1	1	1	1	-	-	-	-	1	-	-	-	-	-	-	-	-	-	-
Iodine, In Alcohol	Liquid	1	1	1	1	1	-	X	X	2	-	1	-	1	-	1	-	-	-	-	-
Iron Acetate Liquor (Black Liquor)	Black Liquid	1	1	1	1	2	2	X	X	2	2	1	2	2	-	1	1	1	1	-	1
Iron Hydroxide	Brown Precipitate	1	-	-	-	1	1	-	X	1	1	1	1	-	-	-	-	-	-	-	-
Iron Ore (Hematite)	Black to Brick Red	-	-	-	-	-	-	1	-	-	-	-	-	-	-	-	-	-	-	-	-
Iron Oxide (Black, Brown, Red or Yellow)	Solid	-	-	-	-	-	-	1	-	-	-	-	-	-	-	-	-	-	-	-	-
Iron Oxide Slurry	Slurry	-	-	-	-	-	-	1	-	-	-	-	-	-	-	-	-	-	-	-	-
Iron Salts	-	1	-	-	-	1	1	-	1	1	1	1	1	-	1	1	-	-	-	-	-
Iron Sulfate Solution (Ferric Sulfate)	Liquid	1	1	1	-	2	2	2	-	2	2	1	2	1	-	1	X	1	1	X	X
Iron Sulfide Solution (Ferrous Sulfide)	Liquid	1	1	-	-	-	-	-	-	-	1	-	-	-	-	-	-	-	-	-	-
Isoamyl Acetate	Colorless Liquid	1	-	-	-	2	X	-	X	X	X	X	X	-	-	-	-	-	-	-	-
Isoamyl Alcohol (Isobutyl Carbinol)	Colorless Liquid	1	-	-	-	2	2	-	2	2	2	2	2	1	-	-	-	-	-	-	-
Isoamyl Bromide	-	1	-	-	-	X	X	-	X	X	2	X	X	-	-	-	-	-	-	-	-
Isoamyl Butyrate	Water White Liquid	1	-	-	-	X	-	X	-	X	X	X	-	-	-	-	-	-	-	-	-
Isoamyl Chloride	Colorless to Yellow Liquid	1	2	-	-	-	-	-	-	-	1	-	X	-	-	-	-	-	-	-	-
Isoamyl Ether	Colorless Liquid	1	-	-	-	X	-	X	-	X	X	X	X	-	-	-	-	-	-	-	-
Isoamyl Phthalate	Colorless Liquid	1	-	-	-	X	-	X	-	2	X	X	X	-	-	-	-	-	-	-	-
Isobutane	Colorless Gas	USE LPG HOSE ONLY																			
Isobutane Liquid	Liquid @ 98 PSIG, 120°F (49°C)	1	-	-	-	-	-	-	-	-	1	-	-	-	-	-	-	-	-	-	-
Isobutanol (Isobutyl Alcohol)	Colorless Liquid	1	1	1	1	1	2	2	2	2	2	1	1	1	1	2	1	1	1	1	2
Isobutene (Isobutylene)	Gas	1	-	-	-	X	1	X	X	-	-	2	X	-	-	-	-	-	-	-	-
Isobutyl Acetate	Colorless Liquid	1	-	-	-	X	X	-	X	X	X	X	2	-	-	-	-	-	-	-	-
Isobutyl Alcohol (Isobutanol)	Colorless Liquid	1	1	1	1	1	2	2	2	2	2	1	1	1	1	2	1	1	1	1	2

<sup>1</sup> Petroleum hose only.

- AGRICULTURE
- AIR BREATHING
- AIR DUCT
- AIR AND MULTI-PURPOSE
- CHEMICAL
- FOOD AND BEVERAGE
- MARINE AND ENGINE
- MATERIAL HANDLING
- MINING
- OILFIELD
- PETROLEUM
- PRESSURE WASH AND WASHDOWN
- STEAM
- WATER
- CLAMPS
- COUPLINGS AND FERRULES
- HOSE FINDER
- CHEMICAL RESISTANCE TABLE

## Chemical Resistance Table

AGRICULTURE	Contact Denver Product Application for recommendations for chemicals not listed. Phone (303) 744-5070		Gates Hose / Polymers														Couplings / Adapters							
			Chem Master™ Xtreme™ FEP	Chem Master™ Plus XLPE	Chem Master™ Plus UHMWPE	Food & Beverage Master																		
			T	K	L	S	P	C	D	D	A	H	V	M	J	Z	G	Iron/Carbon Steel	Stainless Steel 304	Stainless Steel 316	Aluminum	Brass	Polypropylene	
AIR BREATHING	1 = Preferred - Constant Contact 2 = Acceptable - Intermittent Contact X = Not Recommended - = No Data		NOTE: Ratings are for the effect on the polymer only!																					
AIR DUCT																								
AIR AND MULTI-PURPOSE	Chemical	Form (at room temperature unless otherwise stated)	FEP	Gartron™	UHMWPE	Sanitron™	EPDM	NR	SBR	NR	Chloroprene	Butyl	Fluorocarbon	Hyalon®	CPE	Nylon	PVC	Iron/Carbon Steel	Stainless Steel 304	Stainless Steel 316	Aluminum	Brass	Polypropylene	
CHEMICAL	Isobutyl Aldehyde (Isobutyraldehyde)	Colorless Liquid	1	-	-	-	2	X	-	X	X	X	X	X	2	-	-	-	-	-	-	-	-	-
	Isobutyl Carbinol (Primary Isoamyl Alcohol)	Colorless Liquid	1	-	-	-	2	2	-	2	2	2	2	2	2	-	-	-	-	-	-	-	-	-
FOOD AND BEVERAGE	Isobutylamine	Colorless Liquid	1	-	-	-	-	X	-	X	-	2	X	X	-	-	-	-	-	-	-	-	-	-
	Isobutylene (Isobutene)	Gas	1	-	-	-	X	1	X	X	-	-	2	X	-	-	-	-	-	-	-	-	-	-
	Isobutylene Liquid (Isobutene Liquid)	Liquid @ 88 PSIG, 120°F (49°C)	1	-	-	-	-	-	-	-	-	-	1	-	-	-	-	-	-	-	-	-	-	-
MARINE AND ENGINE	Isobutyraldehyde (Isobutyl Aldehyde)	Colorless Liquid	1	-	-	-	2	X	-	X	X	X	X	X	-	-	-	-	-	-	-	-	-	-
	Isocyanate (Toluene Diisocyanate)	Water White to Yellow Liquid	1	2	1	X	X	X	X	X	X	X	1	-	-	1	-	1	1	1	1	-	-	-
	Isooctane	Colorless Liquid	1	2	-	X	X	1	X	X	1	X	1	1	2	1	X	1	1	1	2	1	-	-
MATERIAL HANDLING	Isooctyl Adipate	Viscous Liquid	1	1	-	-	-	-	-	-	-	-	1	-	-	-	-	-	-	-	-	-	-	-
	Isooctyl Alcohol	Clear Liquid	1	1	1	1	1	-	-	-	-	-	1	-	-	-	-	-	-	-	-	-	-	-
	Isooctyl Thioglycolate	Water White Liquid	1	1	-	-	2	-	-	-	-	-	1	-	-	-	-	-	-	-	-	-	-	-
MINING	Isopentane	Colorless Liquid	1	2	-	-	-	-	-	-	-	-	1	-	-	-	-	-	-	-	-	-	-	-
	Isophorone	Water White Liquid	1	-	-	-	-	-	-	-	-	-	-	-	-	-	-	-	-	-	-	-	-	-
	Isophthaloyl Chloride	Liquid above 106°F (41°C)	1	-	-	-	-	-	-	-	-	-	1	-	-	-	-	-	-	-	-	-	-	-
OILFIELD	Isopropanol (Isopropyl Alcohol)	Colorless Liquid	1	1	1	1	1	1	2	2	2	1	1	2	1	1	2	1	1	1	1	1	2	1
	Isopropanolamine (MIPA)	Liquid	1	2	-	-	-	2	-	2	-	1	X	X	-	1	X	1	1	1	1	1	1	-
	Isopropyl Acetate	Colorless Liquid	1	1	1	1	2	X	X	X	2	-	X	-	1	X	1	1	1	1	1	1	1	-
PETROLEUM	Isopropyl Alcohol (Isopropanol)	Colorless Liquid	1	1	1	1	1	2	2	2	1	1	2	1	1	2	1	1	1	1	1	1	2	1
	Isopropyl Benzene (Cumene)	Colorless Liquid	1	2	-	X	-	-	-	-	-	-	1	-	X	-	-	-	-	-	-	-	-	-
	Isopropyl Chloride	Colorless Liquid	1	-	-	-	-	-	-	-	-	-	1	-	X	-	-	-	-	-	-	-	-	-
PRESSURE WASH AND WASHDOWN	Isopropyl Ether	Colorless Liquid	1	1	1	-	X	X	X	X	X	2	X	X	X	1	X	1	1	1	1	1	1	-
	Isopropylamine	Colorless Liquid	1	1	-	2	-	-	-	-	-	-	-	-	-	-	-	-	-	-	-	-	-	-
	Isopropylbenzene (Cumene)	Colorless Liquid	1	2	-	X	-	-	-	-	-	-	1	-	X	-	-	-	-	-	-	-	-	-
STEAM	Isopropyltoluene (Cymene)	Colorless Liquid	1	-	-	-	-	-	-	-	-	-	1	-	X	1	-	1	1	1	1	1	1	-
	<b>J</b>																							
	Jet Fuel A and A1 <sup>2</sup>	Liquid	1	-	-	-	-	1	-	-	-	-	1	-	X	-	-	-	-	-	-	-	-	-
WATER	Jet Fuel JP1 <sup>2</sup>	Liquid	1	1	-	X	X	1	X	X	2	X	1	X	X	1	X	-	-	-	-	-	-	-
	Jet Fuel JP10 (Tetrahydrodicyclopentadiene) <sup>2</sup>	Liquid	1	-	-	X	X	X	X	X	X	1	X	-	1	X	-	-	-	-	-	-	-	-
	Jet Fuel JP4 <sup>2</sup>	Liquid	1	1	-	X	X	1	X	X	2	X	1	X	X	1	X	2	1	1	2	1	1	-
CLAMPS	Jet Fuel JP5 <sup>2</sup>	Liquid	1	1	-	X	X	1	X	X	X	1	X	X	1	X	2	1	1	2	1	1	1	-
	Jet Fuel JP8 <sup>2</sup>	Liquid	1	1	-	X	X	1	X	X	X	1	X	-	1	X	2	1	1	2	1	1	1	-
	<b>K</b>																							
COUPLINGS AND FERRULES	Kaolin Clay	White to Yellowish Powder	1	-	1	-	-	-	-	1	-	-	-	-	-	-	-	-	-	-	-	-	-	-
	Karo Syrup	Yellow Liquid	-	-	-	1	-	-	-	-	-	-	-	-	-	1	1	-	1	1	-	-	-	-
	Kerosene	Water White Oily Liquid	1	1	-	X	X	1	X	X	X	X	1	X	1	1	2	1	1	1	1	1	1	1
HOSE FINDER	Ketchup	Red Liquid	-	-	-	1	-	1	-	-	1	-	-	-	-	1	-	-	1	1	-	-	-	-
	Ketoglutaric Acid	In Water or Alcohol	1	1	1	1	2	-	-	-	-	-	-	-	-	-	-	-	-	-	-	-	-	-
	Ketones (ie Acetone, MEK, Cyclohexanone)	Generally Liquids	1	1	1	1	2	X	X	X	X	2	X	X	-	1	X	1	1	1	1	1	1	-
CHEMICAL RESISTANCE TABLE	Koch Acid	White Solid	-	-	-	-	-	-	-	1	-	-	-	-	-	-	-	-	-	-	-	-	-	-
	<b>L</b>																							
	Lacquer - Alcohol or Acetate as Solvent	Solution	1	1	1	1	2	-	-	-	-	-	X	-	-	-	-	-	X	X	1	1	1	-
CHEMICAL RESISTANCE TABLE	Lacquer - Toluene or Xylene as Solvent	Solution	1	-	-	-	-	X	X	X	X	X	1	X	-	1	X	X	X	1	1	1	1	-
	Lactic Acid (90% or less)	Colorless-Yellow Liquid	1	1	1	1	2	X	2	2	1	-	1	1	-	-	X	X	2	1	X	2	-	-
	Lactic Acid, Food-Grade - 50-80%	Colorless to Yellow Liquid	1	1	1	1	2	-	X	X	-	X	1	1	-	-	-	X	2	1	X	2	-	-
CHEMICAL RESISTANCE TABLE	Lactic Acid, Plastic Grade - 50-80% or less	Colorless to Yellow Liquid	1	1	1	1	2	1	-	-	1	-	1	1	-	X	1	X	2	1	X	2	-	-
	Lactic Acid, USP 85-90% or less	Colorless to Yellow Syrupy Liquid	-	-	-	1	-	-	-	-	-	-	-	-	-	-	-	X	2	1	X	2	-	-
	Lactol	-	1	1	-	-	2	-	-	2	-	-	-	-	-	-	-	1	1	1	-	1	-	-
CHEMICAL RESISTANCE TABLE	Lard (Fat of the Hog)	Liquid above 108°F (42°C)	1	1	1	X	X	1	X	X	2	X	1	X	1	1	-	1	1	1	1	X	-	-

<sup>2</sup> Aircraft fueling hose only for fueling operations.

# Chemical Resistance Table

Contact Denver Product Application for recommendations for chemicals not listed.  
Phone (303) 744-5070

- 1 = Preferred - Constant Contact
- 2 = Acceptable - Intermittent Contact
- X = Not Recommended
- = No Data

NOTE: Ratings are for the effect on the polymer only!

Chemical	Form (at room temperature unless otherwise stated)	Gates Hose / Polymers														Couplings / Adapters						
		Chem Master™ Xtreme™ FEP	Chem Master™ Plus XLPE	Chem Master™ Plus UHMWPE	Food & Beverage Master																	
		T	K	L	S	P	C	D	D	A	H	V	M	J	Z	G	Iron/Carbon Steel	Stainless Steel 304	Stainless Steel 316	Aluminum	Brass	Polypropylene
Lard Oil	Colorless to Yellow Liquid	1	1	-	-	-	-	-	2	-	X	-	-	-	-	1	1	1	1	1	X	-
Lasso (Alachlor)	Colorless Crystals	1	1	-	-	-	-	-	1	-	-	-	-	-	-	-	1	1	1	1	-	-
Latex Paint	Liquid	1	1	1	1	1	1	2	2	-	2	1	-	-	1	1	1	1	1	1	1	-
Lauryl Peroxide	White Powder	-	-	-	-	-	-	-	1	-	-	-	-	-	-	-	-	-	-	-	-	-
Lauryl Alcohol	Liquid above 75°F (24°C)	1	-	-	-	-	-	-	-	-	1	-	1	-	-	-	-	-	-	-	-	-
Lead Acetate	White Crystals	-	-	-	-	-	-	-	1	-	-	-	-	-	-	2	1	1	-	1	-	-
Lead Acetate Solution	Solution	1	1	1	1	1	2	2	2	-	2	1	-	1	-	1	2	1	1	-	1	-
Lead Arsenate	White Crystals	1	-	-	-	-	-	-	1	-	-	-	-	-	-	1	1	1	-	-	-	-
Lead Arsenate Solution (In Nitric Acid)	Solution	1	1	-	-	-	-	-	-	-	1	2	-	-	-	-	-	-	-	-	-	-
Lead Nitrate Solution (In Water or Alcohol)	Solution	1	1	1	1	1	1	2	2	2	2	1	-	1	-	1	1	1	1	-	-	-
Lead Silicate (basic)	White Powder	-	-	-	-	-	-	-	1	-	-	-	-	-	-	-	-	-	-	-	-	-
Lead Sulphate (Basic, Blue Basic, Tribasic)	White to Blue Powder	-	-	-	-	-	-	-	1	-	-	-	-	-	-	1	1	1	-	-	-	-
Lead, Tetraethyl (Tetraethyl Lead)	Colorless Oily Liquid	1	2	-	-	X	2	X	X	X	X	1	X	-	2	1	-	-	-	-	-	-
Lead, Tetramethyl (Tetramethyl Lead)	Colorless Liquid	1	-	-	-	X	2	X	X	X	X	1	X	-	-	-	-	-	-	-	-	-
Lecithin	Light Brown Viscous Liquid-Solid	1	1	-	-	-	X	-	2	-	-	-	-	-	-	-	1	1	-	-	-	-
Ligroin	Clear Liquid	1	2	-	-	X	1	X	X	X	X	1	X	-	1	X	2	1	1	-	-	-
Lime (Calcium Oxide)	White to Gray Lumpy Solid	-	-	-	-	-	-	-	1	-	-	-	-	-	-	-	-	2	-	-	-	-
Lime Sulfur Solution	Solution	1	1	1	1	2	X	X	X	1	X	1	2	-	-	2	2	1	1	X	X	-
Lime, Chlorinated (Bleaching Solution)	Solution	1	1	1	1	2	2	2	2	X	2	1	X	-	-	2	X	2	1	-	-	-
Lime, Chlorinated (normal 35-37% Chlorine)	White Powder	-	-	-	-	-	-	-	1	-	-	-	-	-	-	-	-	2	-	-	-	-
Lime, Hydraulic (Calcined Limestone)	Powder	-	-	-	-	-	-	-	1	-	-	-	-	-	-	-	-	-	-	-	-	-
Lime, Slaked (Calcium Hydroxide)	White Crystalline Powder	-	-	-	-	-	-	-	1	-	-	-	-	-	-	-	-	-	-	-	-	-
Limestone	Powder or Lumps	-	-	-	-	-	-	-	1	-	-	-	-	-	-	-	-	-	-	-	-	-
Limonene	Colorless Liquid	1	2	1	X	X	X	X	X	-	1	-	-	-	1	-	1	1	1	1	1	-
Lindane (Ag Spray)	-	1	1	-	-	-	-	-	-	-	-	-	-	1	-	-	1	1	-	-	-	-
Linoleic Acid	Colorless to Straw Colored Liquid	1	1	1	-	X	2	-	-	X	X	1	-	-	1	-	-	-	-	-	-	-
Linseed/Flax Seed	Yellow Amber to Brown Liquid	1	1	X	2	2	2	X	X	2	-	1	1	1	1	1	2	1	1	1	2	-
Liquid Soap	Liquid	1	1	1	-	2	-	2	2	-	2	-	-	-	-	2	1	1	1	1	1	-
Lithium Chloride	White Crystals	-	-	X	-	-	-	-	1	-	-	-	-	-	-	-	-	-	-	-	-	-
Lithium Chloride (35-40% Brine)	Solution	X	1	X	-	-	-	-	-	-	1	-	-	-	-	-	-	-	-	-	-	-
Lubricating Oil Diester (Under 135°F/57°C)	Liquid	1	1	-	-	X	2	X	X	-	X	1	-	-	-	X	1	1	1	1	1	-
Lubricating Oil (SAE 10, 20, 30, 40, & 50)	Liquid	1	-	-	-	-	2	-	-	2	-	-	-	-	1	-	1	1	1	1	1	-
Lubricating Oil (Under 120°F/49°C)	Liquid	1	1	-	-	X	1	X	X	2	X	1	2	1	1	2	1	1	1	1	1	-
<b>M</b>																						
Machine Oil (Under 135°F/57°C)	Liquid	1	1	-	-	X	1	X	X	1	X	1	2	-	1	2	1	1	1	1	1	-
Magnesite	White to Brown Crystalline Solid	-	-	-	-	-	-	-	1	-	-	-	-	-	-	-	-	-	-	-	-	-
Magnesium	Powder	-	-	-	-	-	-	-	1	-	-	-	-	-	-	-	-	-	-	-	-	-
Magnesium Acetate	Colorless Crystalline Aggregate	-	-	-	-	-	-	-	1	-	-	-	-	-	-	-	-	-	-	-	-	-
Magnesium Acetate Solution	In Water or Alcohol	1	1	1	1	1	1	1	1	-	1	1	1	1	1	1	-	-	-	-	-	-
Magnesium Carbonate	White Powder	-	-	-	-	-	-	-	1	-	-	-	-	-	-	1	1	1	-	-	-	-
Magnesium Carbonate Solution (in Acid)	Liquid Solution	1	1	1	1	-	-	-	-	-	1	-	-	-	-	-	1	1	1	-	-	-
Magnesium Chloride	Colorless to White Crystals	1	-	1	-	-	-	-	1	-	-	-	-	-	-	X	2	1	X	2	-	-
Magnesium Chloride Brine	Solution	1	1	1	1	1	1	-	1	-	-	1	-	-	-	-	-	-	-	-	-	-
Magnesium Chloride, Hydrated (in H2O or Alcohol)	Solution	1	1	1	1	1	-	-	1	-	-	1	-	-	-	-	-	-	-	-	-	-
Magnesium Hydroxide	White Powder	-	-	-	-	-	-	-	1	-	-	-	-	-	-	1	1	1	X	-	-	-
Magnesium Hydroxide Solution (in Dilute Acid)	Liquid Solution	1	1	1	-	-	-	-	-	-	1	-	-	-	-	-	1	1	1	X	-	-
Magnesium Nitrate	White Crystals	-	-	-	-	-	-	-	1	-	-	-	-	-	-	-	1	1	1	X	1	-
Magnesium Nitrate Solution (in H2O or Alcohol)	Liquid Solution	1	1	1	1	1	1	-	-	-	-	1	-	-	-	-	1	1	1	X	1	-

AGRICULTURE

AIR BREATHING

AIR DUCT

AIR AND MULTI-PURPOSE

CHEMICAL

FOOD AND BEVERAGE

MARINE AND ENGINE

MATERIAL HANDLING

MINING

OILFIELD

PETROLEUM

PRESSURE WASH AND WASHDOWN

STEAM

WATER

CLAMPS

COUPLINGS AND FERRULES

HOSE FINDER

CHEMICAL RESISTANCE TABLE

# Chemical Resistance Table

AGRICULTURE

AIR BREATHING

AIR DUCT

AIR AND MULTI-PURPOSE

CHEMICAL

FOOD AND BEVERAGE

MARINE AND ENGINE

MATERIAL HANDLING

MINING

OILFIELD

PETROLEUM

PRESSURE WASH AND WASHDOWN

STEAM

WATER

CLAMPS

COUPLINGS AND FERRULES

HOSE FINDER

CHEMICAL RESISTANCE TABLE

Contact Denver Product Application for recommendations for chemicals not listed.  
Phone (303) 744-5070

1 = Preferred - Constant Contact  
2 = Acceptable - Intermittent Contact  
X = Not Recommended  
- = No Data

NOTE: Ratings are for the effect on the polymer only!

Chemical	Form (at room temperature unless otherwise stated)	Gates Hose / Polymers														Couplings / Adapters											
		Chem Master™ Xtreme™ FEP	Chem Master™ Plus XLPE	Chem Master™ Plus UHMWPE	Sanitron™ Food & Beverage Master	EPDM	NR	SBR	NR	Chloroprene	Butyl	Fluorocarbon	Hypalon®	CPE	Nylon	PVC	Iron/Carbon Steel	Stainless Steel 304	Stainless Steel 316	Aluminum	Brass	Polypropylene					
Magnesium Oxide, Dry	White Powder	-	-	-	-	-	-	-	1	-	-	-	-	-	-	-	-	-	-	-	-	-	-				
Magnesium Oxide, Slurry	-	1	1	-	1	2	-	2	1	-	1	-	-	-	-	-	-	-	-	-	-	-	-				
Magnesium Sulfate Solution	Liquid Solution	1	1	1	1	1	1	1	2	1	1	1	1	-	1	2	1	1	-	1	-	-	-				
Malathion (Ag Spray Dilute)	Clear to Amber Liquid	1	1	1	-	2	-	X	X	-	1	1	-	-	1	1	1	1	-	1	-	-	-				
Malathion (Ag Spray)	Clear to Amber Liquid	1	1	-	-	2	-	-	-	-	1	-	-	-	1	-	1	1	-	1	-	-	-				
Maleic Acid	Liquid	NO HOSE AVAILABLE														-	-	-	-	-	-	-	-	-	-	-	
Maleic Acid Solution	Solution	1	1	1	1	1	2	2	2	X	-	7	-	-	-	X	2	2	1	-	-	-	-				
Maleic Anhydride	Colorless Needles	1	-	-	-	-	-	-	-	-	-	-	-	-	-	-	-	-	-	-	-	-	-				
Maleic Anhydride (Heated Liquid)	Liquid above 124°F (53°C)	1	-	X	-	-	-	-	-	-	-	-	-	-	-	-	-	-	-	-	-	-	-				
Malic Acid (dl form)	Colorless Crystals	-	-	-	-	-	-	-	1	-	-	-	-	-	-	-	-	-	-	-	-	-	-				
Malic Acid Solution (in H2O or Alcohol)	Solution	1	1	1	1	2	-	-	-	-	1	-	-	-	-	-	-	-	-	-	-	-	-				
Malt Extract (Maltine)	Light Brown Viscous Liquid	1	1	1	1	1	-	-	-	-	1	-	-	-	-	-	-	-	-	-	-	-	-				
Malt, Dry	Yellow to Amber Grain	-	-	-	-	-	-	-	1	-	-	-	-	-	-	-	-	-	-	-	-	-	-				
Maltine (Malt Extract)	Light Brown Viscous Liquid	1	1	1	1	1	-	-	-	-	1	-	-	-	-	-	-	-	-	-	-	-	-				
Manganese Salts	-	11	-	-	-	1	X	X	-	1	1	-	-	1	-	-	-	-	-	-	-	-	-				
Manganese Sulfate (Manganous Sulfate)	Pale Red Solid	-	-	-	-	-	-	1	-	-	-	-	-	-	-	-	-	-	-	-	-	-	-				
Manganese Sulfate Solution	Solution in Water	1	1	-	-	1	2	2	-	1	1	1	-	1	-	-	-	-	-	-	-	-	-				
Manganese Sulfide (Manganous Sulfide)	Green Crystals	-	-	-	-	-	-	1	-	-	-	-	-	-	-	-	-	-	-	-	-	-	-				
Manganese Sulfite (Manganous Sulfite)	Black to Brownish Red Powder	-	-	-	-	-	-	1	-	-	-	-	-	-	-	-	-	-	-	-	-	-	-				
MAPP Gas (Methylacetylene Propadiene)	Liquid	USE LPG HOSE ONLY														-	-	-	-	-	-	-	-	-	-	-	
Maxmul (Penzoil Hydraulic Fluid)	Liquid	1	-	-	-	1	-	-	2	-	-	-	-	-	-	1	-	1	-	-	-	-	-				
Mayonnaise	Semi-Liquid	1	1	-	2	-	-	-	-	-	-	-	-	-	1	-	-	-	-	-	-	-	-				
MBK (Methyl Butyl Ketone)	Colorless Liquid	1	1	-	-	2	X	X	X	X	2	X	X	2	-	X	1	1	1	1	1	1	1				
MEK (Methyl Ethyl Ketone)	Colorless Liquid	1	2	1	1	2	X	X	X	X	2	X	X	2	1	X	1	1	1	1	1	1	1				
Mercuric Chloride	White Powder	-	-	-	-	-	-	1	-	-	-	-	-	-	-	X	1	1	X	X	-	-	-				
Mercuric Chloride Solution (in H2O or Alcohol)	Solution	1	1	-	-	2	2	2	1	1	2	-	1	1	-	2	X	1	1	X	X	-	-				
Mercuric Cyanide	Colorless Transparent Prisms	-	-	-	-	-	-	1	-	-	-	-	-	-	-	-	-	-	-	X	-	-	-				
Mercuric Cyanide Solution (in H2O or Alcohol)	Solution	1	1	-	-	2	2	2	2	1	2	-	1	-	-	-	-	-	X	-	-	-	-				
Mercurous Nitrate Solution	Solution	1	1	1	-	2	-	-	-	-	1	-	-	-	-	1	1	1	X	-	-	-	-				
Mercury	Silver Liquid	1	1	1	-	2	2	2	1	2	-	1	1	-	1	1	1	1	X	X	-	-	-				
Mercury Vapor	Gas	NO HOSE AVAILABLE														-	-	-	-	-	-	-	-	-	-	-	-
Mesityl Oxide (Methyl Isobutenyl Ketone)	Colorless Oily Liquid	1	1	1	-	2	X	X	X	X	2	X	X	2	-	X	1	1	1	1	1	1	1				
Mesitylene (Trimethylbenzene)	Liquid	1	-	-	X	X	X	X	X	X	1	-	-	1	X	-	-	-	-	-	-	-	-				
Metallic Soaps (Aluminium, Calcium, Zinc)	Solids @ Room Temperature	1	1	1	-	X	1	X	X	-	X	1	2	1	-	-	1	1	1	1	1	1	1				
Methallyl Alcohol (Methylallyl Alcohol)	Colorless Liquid	1	-	-	-	1	-	2	-	2	2	-	-	-	-	-	-	-	-	-	-	-	-				
Methane	Gas	1	-	-	-	1	-	-	-	-	1	-	-	-	-	-	-	-	-	-	-	-	-				
Methanol (Methyl Alcohol)	Colorless Liquid	1	1	1	1	1	1	1	1	1	1	X	1	1	1	2	1	1	1	1	1	2	-				
Methionine	White Crystalline Powder	-	-	-	-	-	-	1	-	-	-	-	-	-	-	-	-	-	-	-	-	-	-				
Methoxychlor Solution (in Alcohol)	Solution	1	1	-	-	-	-	-	-	-	-	-	-	1	-	1	1	1	-	-	-	-	-				
Methylamine (Monomethylamine)	Liquid	1	-	-	-	-	-	-	-	-	-	-	-	-	1	X	1	1	1	-	-	-	-				
Methyl Acetate	Colorless Liquid	1	2	-	-	2	X	X	X	X	2	X	X	1	1	X	1	1	1	1	1	1	1				
Methyl Acetoacetate	Colorless Liquid	1	-	-	-	2	X	-	X	X	2	X	X	-	-	-	-	-	-	-	-	-	-				
Methyl Acetone	Water White Liquid	1	-	-	-	1	X	-	X	-	2	X	X	-	-	1	-	-	-	-	-	-	-				
Methyl Acrylate (Inhibited)	Colorless Liquid	1	2	-	2	2	X	X	X	X	X	X	X	-	-	-	1	1	1	1	1	1	1				
Methyl Acrylate Acid (Methylacrylic Acid)	White Solid	1	1	1	1	2	2	X	X	-	1	1	-	1	X	-	-	-	-	-	-	-	-				
Methyl Alcohol (100%) (Methanol)	Colorless Liquid	1	1	1	1	1	1	1	1	1	1	X	1	1	1	2	1	1	1	1	1	2	-				
Methyl Bromide	Liquid @ 55 PSIG @ 120°F (49°C)	1	1	-	-	X	X	X	X	X	X	1	X	-	1	X	1	1	1	-	1	-	-				
Methyl Bromoacetate	Colorless to Straw Colored Liquid	1	1	1	-	-	-	-	-	-	-	-	-	-	-	-	-	-	-	-	-	-	-				

# Chemical Resistance Table

Contact Denver Product Application for recommendations for chemicals not listed.  
Phone (303) 744-5070

1 = Preferred - Constant Contact  
2 = Acceptable - Intermittent Contact  
X = Not Recommended  
- = No Data

NOTE: Ratings are for the effect on the polymer only!

Chemical	Form (at room temperature unless otherwise stated)	Gates Hose / Polymers																	Couplings / Adapters				
		Chem Master™ Xtreme™ FEP	Chem Master™ Plus XLPE	Chem Master™ Plus UHMWPE	Food & Beverage Master				Gates Hose / Polymers							Couplings / Adapters							
		T	K	L	S	P	C	D	D	A	H	V	M	J	Z	G	Iron/Carbon Steel	Stainless Steel 304	Stainless Steel 316	Aluminum	Brass	Polypropylene	
FEP	Gaion™	UHMWPE	Sanitron™	EPDM	NR	SBR	NR	Chloroprene	Butyl	Fluorocarbon	Hypalon®	CPE	Nylon	PVC	Iron/Carbon Steel	Stainless Steel 304	Stainless Steel 316	Aluminum	Brass	Polypropylene			
Methyl Butanethiol (Butyl Mercaptan)	Liquid	1	1	-	X	X	-	-	-	X	1	-	-	-	X	1	1	1	-	-	-		
Methyl Butanol (2-Methyl-1-Butanol)	Colorless Liquid	1	1	1	1	1	-	-	-	1	1	-	1	1	1	-	-	-	-	-	-		
Methyl Butyl Ketone (MBK)	Colorless Liquid	1	1	-	-	2	X	X	X	X	2	X	X	2	-	X	1	1	1	1	1	-	
Methyl Carbitol (Diethylene Glycol Methyl Ether)	Colorless Liquid	1	1	-	1	1	-	X	X	-	X	1	X	1	-	-	-	-	-	-	-		
Methyl Cellosolve (Diethylene Glycol Methyl Ether)	Colorless Liquid	1	1	-	1	1	-	X	X	-	X	1	X	1	-	-	-	-	-	-	-		
Methyl Chloride	Liquid @ 160PSIG @ 120°F (49°C)	1	2	-	X	X	X	X	X	X	1	X	X	-	X	1	1	1	-	1	-		
Methyl Chloroform (1,1,1 Trichloroethane)	Colorless Liquid	1	2	-	X	X	X	X	X	X	1	X	X	X	X	-	-	-	-	-	-		
Methyl Chloroformate	Colorless Liquid	1	-	-	-	X	X	X	X	X	1	X	-	-	-	-	-	-	-	-	-		
Methyl Cyanide (Acetonitrile)	Colorless Liquid	1	1	2	1	2	X	2	2	X	X	X	1	-	1	1	1	1	-	-	-		
Methyl Cyclohexane	Colorless Liquid	1	-	-	X	X	1	X	X	-	X	1	X	2	1	-	-	-	-	-	-		
Methyl Ethyl Ketone (MEK)	Colorless Liquid	1	2	1	1	2	X	X	X	X	2	X	X	2	1	X	1	1	1	1	1	-	
Methyl Formate	Colorless Liquid	1	1	-	-	2	X	X	X	2	2	X	X	-	-	-	1	1	1	1	1	-	
Methyl Hexanol	-	1	-	-	-	-	1	-	1	-	1	2	1	-	-	-	-	-	-	-	-		
Methyl Hexanone (Methyl Isoamyl Ketone)	Colorless Liquid	1	-	-	-	-	X	-	X	-	2	X	X	-	-	-	-	-	-	-	-		
Methyl Hexyl Ketone	Colorless Liquid	1	-	-	-	-	X	-	X	-	2	X	X	-	-	-	-	-	-	-	-		
Methyl Isoamyl Ketone (Methyl Hexanone)	Colorless Liquid	1	-	-	-	-	X	-	X	-	2	X	X	-	-	-	-	-	-	-	-		
Methyl Isobutenyl Ketone (Mesityl Oxide)	Colorless Oily Liquid	1	1	1	-	2	X	X	X	2	X	X	X	-	X	1	1	1	1	1	1	-	
Methyl Isobutyl Ketone (MIBK)	Colorless Liquid	1	2	-	-	-	X	X	X	X	2	X	X	X	1	X	-	-	-	-	-		
Methyl Isopropyl Ketone	Colorless Liquid	1	2	-	-	2	X	X	X	X	2	X	X	X	1	X	1	1	1	1	1	-	
Methyl Methacrylate	Colorless Liquid	1	2	-	2	2	X	X	X	X	X	2	2	-	1	1	1	1	-	-	-		
Methyl Methacrylate Monomer, Inhibited	Colorless Liquid	1	-	-	-	X	X	X	X	X	X	X	-	X	X	-	-	-	-	-	-		
Methyl Phenol (Cresol)	Liquid above 95°F (35°C)	1	2	-	-	-	X	X	X	X	2	1	X	1	X	-	2	1	1	1	-	2	
Methyl Propyl Carbinol (2 Pentanol)	Colorless Liquid	1	1	1	1	1	-	-	-	-	1	1	-	1	-	-	-	-	-	-	-		
Methyl Propyl Ether	Colorless Liquid	1	-	-	-	-	X	-	X	-	X	-	2	-	-	-	-	-	-	-	-		
Methyl Propyl Ketone (Pentanone)	Water White Liquid	1	-	-	-	2	X	-	X	X	2	X	X	-	X	-	-	-	-	-	-		
Methyl Salicylate	Yellow to Red Liquid	1	1	-	-	2	2	-	-	2	2	-	-	-	-	1	1	1	1	1	1	-	
Methyl Stearate	Liquid above 99°F (38°C)	1	1	-	-	-	-	-	-	-	-	-	-	-	-	-	-	-	-	-	-		
Methyl Sulfate (Dimethyl Sulfate)	Colorless Liquid	1	1	-	-	X	X	X	X	X	2	X	X	-	1	1	-	-	-	-	-		
Methyl-2-Pyrrolidone	Colorless Liquid	-	2	-	-	-	-	-	-	-	-	-	-	-	-	-	-	-	-	-	-		
Methyl-n-Amyl Carbinol	Colorless Liquid	1	1	-	-	-	-	-	-	-	-	-	-	1	-	-	-	-	-	-	-		
Methyl-n-Amylketone	Water White Liquid	1	1	-	-	-	-	-	-	-	-	-	-	-	-	-	-	-	-	-	-		
Methylacetylene Propadiene (MAPP Gas)	Liquid @ 107 PSIG @ 68°F (20°C)	1	-	-	-	-	-	-	-	-	-	1	-	-	-	-	-	-	-	-	-		
Methylacrylic Acid (Crotonic Acid)	White Crystalline Solid	1	1	1	1	2	2	X	X	-	1	1	-	1	X	-	-	-	-	-	-		
Methylal	Colorless Liquid	1	-	-	-	-	-	-	-	-	-	-	-	1	-	-	-	-	-	-	-		
Methylalyl Alcohol (Methalyl Alcohol)	Colorless Liquid	1	-	-	-	-	1	-	2	-	2	2	-	-	-	-	-	-	-	-	-		
Methylalyl Chloride	Colorless to Straw Colored Liquid	1	-	-	-	-	-	-	-	-	-	1	-	-	-	-	-	-	-	-	-		
Methylamine (30-40% in H2O)	Colorless Liquid	1	1	-	-	2	X	-	-	-	-	-	-	-	X	-	-	-	-	-	-		
Methylamine (Anhydrous)	Liquid @ 120 PSIG @ 120°F (49°C)	1	-	-	-	-	-	-	-	-	-	-	-	-	X	-	-	-	-	-	-		
Methylamyl Acetate	Colorless Liquid	1	-	-	-	-	-	-	-	-	-	-	-	-	-	-	-	-	-	-	-		
Methylamyl Alcohol	Colorless Liquid	1	1	-	-	-	-	-	-	-	-	1	-	-	-	-	-	-	-	-	-		
Methylaniline	Colorless to Brown Liquid	1	1	1	1	2	X	-	-	X	-	1	2	-	X	X	-	-	-	-	-		
Methyldiethanolamine	Colorless Liquid	1	1	-	1	-	-	-	-	-	-	-	-	-	-	-	-	-	-	-	-		
Methylene Bromide	Clear Liquid	1	-	-	-	-	2	-	-	-	-	1	-	-	-	X	-	-	-	-	-		
Methylene Chloride (Dichloromethane)	Colorless Liquid	1	1	2	X	X	X	X	X	X	2	X	X	X	X	1	1	1	1	1	1	-	
Methylene Dichloride	Colorless Liquid	1	1	-	X	X	X	X	X	X	1	X	X	X	X	1	1	1	X	1	-		
Methylene Dichloride (Methylene Chloride)	Colorless Liquid	1	1	2	X	X	X	X	X	X	1	X	X	X	X	1	1	1	X	1	-		
Methylene Diphenyl Diisocyanate, MDI	Liquid above 99°F (37°C)	-	1	-	-	-	-	-	-	-	-	-	-	-	-	-	-	-	-	-	-		
Methylstyrene	Colorless Liquid	1	-	-	-	-	-	-	-	-	-	1	-	-	-	-	-	-	-	-	-		

AGRICULTURE
AIR BREATHING
AIR DUCT
AIR AND MULTI-PURPOSE
CHEMICAL
FOOD AND BEVERAGE
MARINE AND ENGINE
MATERIAL HANDLING
MINING
OILFIELD
PETROLEUM
PRESSURE WASH AND WASHDOWN
STEAM
WATER
CLAMPS
COUPLINGS AND FERRULES
HOSE FINDER
CHEMICAL RESISTANCE TABLE

# Chemical Resistance Table

AGRICULTURE
AIR BREATHING
AIR DUCT
AIR AND MULTI-PURPOSE
CHEMICAL
FOOD AND BEVERAGE
MARINE AND ENGINE
MATERIAL HANDLING
MINING
OILFIELD
PETROLEUM
PRESSURE WASH AND WASHDOWN
STEAM
WATER
CLAMPS
COUPLINGS AND FERRULES
HOSE FINDER
CHEMICAL RESISTANCE TABLE

Contact Denver Product Application for recommendations for chemicals not listed.  
Phone (303) 744-5070

1 = Preferred - Constant Contact  
2 = Acceptable - Intermittent Contact  
X = Not Recommended  
- = No Data

NOTE: Ratings are for the effect on the polymer only!

Chemical	Form (at room temperature unless otherwise stated)	Gates Hose / Polymers														Couplings / Adapters							
		Chem Master™ Xtreme™ FEP	Chem Master™ Plus XLPE	Chem Master™ Plus UHMWPE	Food & Beverage Master	EPDM	NR	SBR	NR	Chloroprene	Butyl	Fluorocarbon	Hypalon®	CPE	Nylon	PVC	Iron/Carbon Steel	Stainless Steel 304	Stainless Steel 316	Aluminum	Brass	Polypropylene	
MIBK (Methyl Isobutyl Ketone)	Colorless Liquid	1	2	-	-	-	-	-	-	-	-	-	-	-	-	-	-	-	-	-	-	-	-
Milk	White Liquid	USE FDA HOSE ONLY																					
Mineral Oil	Colorless Liquid	1	1	1	X	X	1	X	X	1	X	1	1	1	1	1	1	1	1	2	1	-	
Mineral Spirits (VM&P Naphtha)	Colorless Liquid	1	1	-	X	X	1	X	X	-	X	1	X	-	1	-	1	1	1	2	1	-	
MIPA (Isopropanolamine)	Liquid	1	-	-	-	-	2	-	2	-	1	X	X	-	-	-	-	-	-	-	-	-	
Mobile Therm 603	Liquid	1	1	-	-	-	1	-	-	-	-	1	-	-	-	-	1	1	1	1	1	-	
Molasses	Brown Liquid	1	1	-	1	1	2	2	2	2	1	1	1	-	-	2	2	1	1	2	X	-	
Monochloroacetic Acid	Colorless to Light Brown Crystals	1	1	X	-	-	-	X	-	-	-	-	-	-	-	-	-	-	-	-	-	-	
Monochloroacetic Acid Solution (in H2O or Alcohol)	Liquid Solution	1	1	X	1	2	-	-	-	-	-	-	-	-	X	-	X	X	X	-	2	1	
Monochlorobenzene	Clear Liquid	1	2	-	X	X	X	X	X	X	X	1	X	X	X	X	1	1	1	-	1	-	
Monoethanolamine	Colorless Liquid	1	2	1	1	2	2	2	2	2	2	X	X	1	1	2	1	1	1	-	1	-	
Monoethylamine	Liquid @ 15 PSIG @ 120°F (49°C)	1	2	-	1	1	X	X	X	X	2	X	X	1	-	-	-	1	1	-	1	-	
Monoethylamine Solution (70% or less)	Liquid Solution	1	1	-	1	-	-	-	-	-	-	-	-	-	-	-	-	-	-	-	-	-	
Monoglycerides	Liquid to Solid	1	1	-	-	-	-	-	-	-	-	-	-	-	-	-	-	-	-	-	-	-	
Monomethylamine (Methylamine)	Liquid @ 120 PSIG @ 120°F (49°C)	1	-	-	-	-	-	-	-	-	-	-	-	X	-	X	1	1	1	-	-	-	
Monopentaerythritol (Pentaerythritol)	White Powder	-	-	-	-	-	-	-	1	-	-	-	-	-	-	-	-	-	-	-	-	-	
Monopentaerythritol Solution	Liquid Solution	1	1	1	1	1	-	-	-	-	-	1	-	-	-	-	-	-	-	-	-	-	
Monosodium Phosphate (Monobasic)	White Powder	1	1	-	-	2	-	2	2	X	2	-	-	1	1	1	-	1	1	X	X	-	
Morpholine	Colorless Liquid	1	-	-	-	-	-	-	-	-	-	-	-	-	-	-	-	-	-	-	-	-	
Mortar, Inorganic	Powder	-	-	-	-	-	-	-	1	-	-	-	-	-	-	-	-	-	-	-	-	-	
Motor Oil	Liquid	1	1	-	X	X	1	X	X	2	X	1	2	1	1	2	1	1	1	1	1	-	
Mould Oil	Liquid	1	1	-	-	-	-	-	-	-	-	-	-	-	-	-	1	1	1	-	-	-	
Mouth Wash	Liquid	1	-	1	1	-	-	-	-	-	-	-	-	-	-	-	1	1	1	1	1	-	
MTBE (Methyl Tertiary Butyl Ether)	Colorless Liquid	-	2	-	2	-	-	-	-	-	X	-	-	-	-	-	-	-	-	-	-	-	
Muriatic Acid (Hydrochloric)	Colorless to Yellow Liquid	1	1	1	1	X	X	2	2	X	2	1	2	1	X	X	X	X	X	X	X	-	
Mustard	Liquid	1	-	2	-	-	1	1	1	1	-	1	-	-	-	X	1	1	-	-	-	-	
<b>N</b>																							
n-Hexaldehyde	Colorless Liquid	1	1	-	-	2	X	X	X	2	1	-	-	-	-	-	-	-	-	-	-	-	
n-Methyl-2-Pyrrolidone	Colorless Liquid	-	2	-	-	-	-	-	-	-	-	-	-	-	-	-	-	-	-	-	-	-	
n-Octane	Colorless Liquid	1	2	1	X	X	1	X	X	-	X	1	X	1	1	X	-	-	-	-	-	-	
Naphtha (Low Aromatic Content)	Liquid	1	1	-	X	X	2	X	X	X	X	1	X	1	-	X	2	1	1	-	1	-	
Naphthalene	White Crystalline Flakes	-	-	-	-	-	-	1	-	-	-	-	-	-	-	-	1	1	1	1	1	-	
Naphthenic Acid	Commercial Grade is Dark Fluid	1	1	-	2	-	2	-	-	-	1	-	-	-	1	-	-	-	-	-	-	-	
Neohexane	Colorless Liquid	1	-	-	-	X	1	-	2	-	1	-	-	1	-	-	-	-	-	-	-	-	
Neutral Oil	Liquid	1	1	1	-	X	2	X	X	2	X	1	-	-	1	-	1	1	1	-	1	-	
Nickel Acetate	Green Crystals	-	-	-	-	-	-	-	1	-	-	-	-	-	-	-	-	1	1	1	1	1	
Nickel Acetate Solution (In Water or Alcohol)	Solution	1	1	1	1	2	-	2	2	-	1	-	-	-	-	-	1	1	1	1	1	-	
Nickel Carbonate	Green to Brown Crystals/Powder	-	-	-	-	-	-	-	1	-	-	-	-	-	-	-	-	-	-	-	-	-	
Nickel Chloride	Brown Deliquescent Scales	-	-	-	-	-	-	-	1	-	-	-	-	-	-	-	X	2	2	X	X	-	
Nickel Chloride Solution (In Water or Alcohol)	Solution	1	1	-	-	2	2	2	2	2	2	1	2	1	-	1	X	2	2	X	X	-	
Nickel Nitrate	Green Deliquescent Crystals	-	-	-	-	-	-	-	1	-	-	-	-	-	-	-	-	-	-	2	X	-	
Nickel Nitrate Solution (In Water or Alcohol)	Solution	1	1	-	-	2	2	2	2	2	2	1	2	1	-	2	-	-	2	X	-	-	
Nickel Plating Solution	Liquid	1	1	-	-	-	2	2	2	-	-	-	2	-	-	X	-	1	1	-	-	-	
Nickel Salts	-	1	1	-	-	1	1	1	1	1	1	1	1	-	1	2	-	-	-	-	-	-	
Nickel Sulfate	Yellow Green to Blue Crystals	-	-	-	-	-	-	-	1	-	-	-	-	-	-	-	-	2	1	X	X	-	
Nickel Sulfate Solution	Solution	1	1	-	-	2	2	2	2	2	2	1	2	1	-	1	-	2	1	X	X	-	
Nicotine Salts (ie Nicotine Hydrochloride)	Colorless Oil	1	1	-	-	-	-	-	-	-	-	-	-	-	-	1	1	X	2	-	-	-	
Niter Cake (Sodium Bisulfate)	Colorless Crystals to White Lumps	1	1	-	-	1	1	1	1	1	1	1	1	1	1	1	X	1	1	X	X	-	

# Chemical Resistance Table

Contact Denver Product Application for recommendations for chemicals not listed.  
Phone (303) 744-5070

- 1 = Preferred - Constant Contact
- 2 = Acceptable - Intermittent Contact
- X = Not Recommended
- = No Data

NOTE: Ratings are for the effect on the polymer only!

Chemical	Form (at room temperature unless otherwise stated)	Gates Hose / Polymers														Couplings / Adapters							
		Chem Master™ Xtreme™ FEP	Chem Master™ Plus XLPE	Chem Master™ Plus UHMWPE	Food & Beverage Master																		
		T	K	L	S	P	C	D	D	A	H	V	M	J	Z	G	Iron/Carbon Steel	Stainless Steel 304	Stainless Steel 316	Aluminum	Brass	Polypropylene	
Niter Cake Solution	Solution	1	1	1	2	2	-	X	X	X	X	2	1	1	1	-	-	-	-	-	-		
Nitric Acid (25% or less)	Colorless Liquid	1	1	1	2	2	X	X	X	X	X	2	1	2	X	X	X	X	2	2	-	X	-
Nitric Acid (10%)	Transparent or Yellowish Liquid	1	1	1	1	1	X	X	X	X	X	2	1	2	X	X	X	X	2	2	-	X	-
Nitric Acid (25%)	Transparent or Yellowish Liquid	1	1	1	2	2	X	X	X	X	X	2	1	2	X	X	X	X	2	2	-	X	-
Nitric Acid (35% or less, 26 Degrees Baume)	Colorless Liquid	1	1	1	2	2	X	X	X	X	X	2	1	1	X	X	X	X	2	2	-	X	-
Nitric Acid (52% or less, 36 Degrees Baume)	Colorless to Yellow Liquid	1	2	X	2	X	X	X	X	X	X	1	2	X	X	X	X	X	2	2	-	X	-
Nitric Acid (61% or less, 40 Degrees Baume)	Colorless to Yellow Liquid	1	2	X	2	X	X	X	X	X	X	1	2	X	X	X	X	X	2	2	-	X	-
Nitric Acid (63.5% or less)	Transparent or Yellowish Liquid	1	X	X	X	X	X	X	X	X	X	1	X	X	X	X	X	X	2	2	-	X	-
Nitric Acid (67% or less, 42 Degrees Baume)	Colorless to Yellow Liquid	1	X	X	X	X	X	X	X	X	X	1	X	X	X	X	X	X	2	2	-	X	-
Nitric Acid (95% or less, 48.5 Degrees Baume)	Yellow Liquid	1	X	X	X	X	X	X	X	X	X	1	X	X	X	X	X	X	2	2	-	X	-
Nitric Acid (Red Fuming)	Red Liquid	1	X	X	X	X	X	X	X	X	X	1	X	X	X	X	-	-	-	-	-	-	-
Nitrobenzene	Yellow Liquid @ 43°F (6°C)	1	2	-	1	2	X	X	X	X	X	2	X	X	2	X	1	1	1	1	1	-	-
Nitroethane	Colorless Liquid	1	1	-	-	2	X	2	2	X	2	-	2	2	-	-	-	1	1	-	1	-	
Nitrogen (Cryogenic Liquid)	Liquid	NO HOSE AVAILABLE														1	1	1	1	1	-		
Nitrogen (Gas)	Colorless Gas	1	1	1	1	1	1	1	1	1	1	1	1	1	1	1	1	1	1	1	1	1	-
Nitrogen Dioxide (Nitrogen Tetroxide)	Liquid @ 50 PSIG @ 120°F (49°C)	1	-	-	-	-	-	-	-	-	-	1	-	-	-	-	-	-	-	-	-	-	-
Nitrogen Fertilizer (Ammonia, Urea)	Solutions in Water	1	1	-	-	-	-	-	-	-	-	-	-	-	-	-	-	-	-	-	-	-	-
Nitrogen Oxide (Nitrous Oxide)	Gas	1	1	-	1	2	X	X	X	X	1	1	1	1	X	X	1	1	1	-	X	-	
Nitrogen Tetroxide (Nitrogen Dioxide)	Liquid @ 50 PSIG @ 120°F (49°C)	1	-	-	-	-	-	-	-	-	-	1	-	-	-	-	-	-	-	-	-	-	-
Nitromethane	Colorless Liquid	1	-	-	-	2	X	-	2	X	2	X	X	-	1	X	-	1	1	-	1	-	
Nitropropane	Colorless Liquid	1	1	-	-	2	X	X	X	X	2	X	-	-	1	-	-	1	1	-	1	-	
Nitrosyl Chloride	Yellow-Red Liquid or Gas	1	1	-	-	-	-	-	-	-	-	-	-	-	-	-	-	1	1	-	-	-	
Nitrous Acid (Up to 10%)	Light Blue Liquid	1	1	1	-	-	-	-	-	1	-	-	1	-	1	1	X	1	1	X	X	-	
Nitrous Oxide (Nitrogen Oxide)	Gas	1	1	-	1	2	X	X	X	X	1	1	1	1	X	X	1	1	1	X	-	-	
Nitrous Oxide, Compressed Liquid	Liquid @ 800 PSIG @ 68°F (20°C)	1	-	-	-	-	-	-	-	-	-	-	-	-	-	-	-	-	-	-	-	-	
Nonene (1-nonylene)	Colorless Liquid	1	-	-	-	-	-	-	-	-	-	1	-	-	-	-	-	-	-	-	-	-	
Nonyl Alcohol (Octyl Carbinol)	Colorless Liquid	1	1	1	1	-	1	-	-	-	-	1	-	-	-	-	-	-	-	-	-	-	
Nonylene (Nonene)	Colorless Liquid	1	-	-	-	-	-	-	-	-	-	1	-	-	-	-	-	-	-	-	-	-	
0																							
Octadecanoic Acid (Stearic Acid)	Colorless Waxy Solid	1	1	1	1	2	2	2	2	2	2	1	2	1	1	1	X	2	1	X	X	-	
Octanoic Acid (Caprylic Acid)	Colorless Oily Liquid	1	-	-	-	-	-	-	-	-	-	-	-	1	-	-	-	-	-	-	-	-	
Octanol (Octyl Alcohol)	Colorless Liquid	1	1	-	-	-	2	2	2	2	-	1	-	1	1	2	1	1	1	1	2	-	
Octene	Colorless Liquid	1	-	-	-	-	-	-	-	-	-	1	-	-	-	-	-	-	-	-	-	-	
Octyl Acetate	Colorless Liquid	1	-	-	-	X	-	X	-	X	X	1	-	-	-	-	-	-	-	-	-	-	
Octyl Alcohol (Octanol)	Colorless Liquid	1	1	-	-	-	2	2	2	2	-	1	-	1	1	2	1	1	1	1	2	-	
Octyl Aldehyde	Colorless Liquid	1	-	-	-	X	-	X	-	X	X	X	-	-	-	-	-	-	-	-	-	-	
Octyl Carbinol (Nonyl Alcohol)	Colorless Liquid	1	1	1	1	-	1	-	-	-	-	1	-	-	-	-	-	-	-	-	-	-	
Octyl Phenol (Diisobutyl Phenol)	White Flakes	1	-	-	-	-	-	1	-	-	-	-	-	-	-	-	-	-	-	-	-	-	
Octylamine	Water White Liquid	1	-	-	-	X	-	X	-	2	X	X	-	-	-	-	-	-	-	-	-	-	
Oil (SAE Motor Oils)	Liquid	1	1	-	X	X	1	X	X	2	X	1	2	1	1	2	-	-	-	-	-	-	
Oil of Turpentine	Liquid	1	2	2	-	X	1	X	X	2	X	1	X	-	1	1	-	-	-	-	-	-	
Oils, Animal (High Fatty Acid Content)	Solid to Liquids	1	2	-	2	X	1	X	X	2	2	1	X	1	-	2	1	1	1	1	1	-	
Oils, Mineral (Aliphatic or Aromatic)	Liquids	1	2	-	X	X	2	X	X	X	X	1	2	2	1	X	-	-	-	-	-	2	
Oils, Vegetable (Soybean, Coconut, Corn)	Liquids	1	1	-	X	X	1	X	X	-	X	1	X	-	1	-	-	-	-	-	-	1	
Oleic Acid (fatty acid)	Yellow to Red Oily Liquid	1	2	2	2	2	2	X	X	2	2	2	X	X	-	2	2	2	1	1	2	1	
Oleum (Fuming Sulfuric, 30% SO3 or less)	Clear to Off White Fuming Liquid	1	X	X	X	X	X	X	X	X	X	1	X	X	X	X	-	-	1	-	-	X	
Olive Oil	Yellow to Green Liquid	1	1	1	2	2	2	X	X	X	2	1	X	2	1	2	2	1	1	1	2	1	
Ortho-Dichlorobenzene (also meta and para)	Colorless Liquid	1	2	-	X	X	X	X	X	X	X	1	X	X	1	X	-	1	1	-	1	-	

AGRICULTURE
AIR BREATHING
AIR DUCT
AIR AND MULTI-PURPOSE
CHEMICAL
FOOD AND BEVERAGE
MARINE AND ENGINE
MATERIAL HANDLING
MINING
OILFIELD
PETROLEUM
PRESSURE WASH AND WASHDOWN
STEAM
WATER
CLAMPS
COUPLINGS AND FERRULES
HOSE FINDER
CHEMICAL RESISTANCE TABLE



# Chemical Resistance Table

AGRICULTURE

AIR BREATHING

AIR DUCT

AIR AND MULTI-PURPOSE

CHEMICAL

FOOD AND BEVERAGE

MARINE AND ENGINE

MATERIAL HANDLING

MINING

OILFIELD

PETROLEUM

PRESSURE WASH AND WASHDOWN

STEAM

WATER

CLAMPS

COUPLINGS AND FERRULES

HOSE FINDER

CHEMICAL RESISTANCE TABLE

Contact Denver Product Application for recommendations for chemicals not listed.  
Phone (303) 744-5070

1 = Preferred - Constant Contact  
2 = Acceptable - Intermittent Contact  
X = Not Recommended  
- = No Data

NOTE: Ratings are for the effect on the polymer only!

Chemical	Form (at room temperature unless otherwise stated)	Gates Hose / Polymers																Couplings / Adapters					
		Chem Master™ Xtreme™ FEP	Chem Master™ Plus XLPE	Chem Master™ Plus UHMWPE	Food & Beverage Master																		
		T	K	L	S	P	C	D	D	A	H	V	M	J	Z	G	Iron/Carbon Steel	Stainless Steel 304	Stainless Steel 316	Aluminum	Brass	Polypropylene	
Ortho-xylene (1,2 Dimethylbenzene)	Clear Colorless Liquid	1	X	X	X	X	X	X	X	X	1	X	X	X	X	-	-	-	-	-	-		
OS 45 Hydraulic Fluid (Silicate Ester Base)	Liquid	1	-	-	-	X	2	X	X	1	X	1	2	-	-	-	-	-	-	-	-		
Oxalic Acid	Transparent Crystals	1	-	2	-	-	-	-	1	-	-	-	X	-	-	X	2	1	2	X	1		
Oxalic Acid (50%)	Crystals in H2O	1	2	1	2	2	X	X	X	X	2	1	2	X	X	X	-	-	-	-	-		
Oxygen	Colorless Gas	1	1	-	1	1	2	2	2	-	1	1	1	1	-	-	-	-	-	-	-		
Oxygen, Refrigerated Liquid	Liquid @ 200 PSIG @ -231°F (-146°C)	NO HOSE AVAILABLE																-	-	-	-	-	-
Ozone	Gas	1	2	2	1	1	X	X	X	2	2	2	2	1	2	1	1	1	1	1	1		
<b>P</b>																							
Paint (Emulsion or Latex)	Liquid	1	1	1	1	2	2	-	-	-	-	1	-	-	1	1	-	-	-	-	-		
Paint (Inorganic)	Liquid	1	-	1	-	-	-	-	-	-	-	-	-	-	-	-	1	1	1	1	-		
Paint (Oil or Solvent Based)	Liquid or Paste	1	1	-	X	X	2	X	X	-	X	1	X	-	1	-	-	-	-	-	-		
Paint Remover	Liquid or Paste	1	2	-	X	X	X	X	X	X	X	1	X	-	X	-	-	-	-	-	-		
Paint Resin	-	1	-	-	-	-	-	-	-	-	-	-	-	-	-	-	-	-	-	-	-		
Palm Oil	Yellow to Brown Solid	1	1	-	-	1	X	X	2	2	-	2	X	-	-	1	1	1	1	1	-		
Palmitic Acid (Hexadecanoic Acid)	Crystals in Hot Alcohols	1	1	1	2	2	2	X	X	2	2	1	X	1	-	-	1	2	1	1	X		
Papermakers Alum (Aluminum Ammonium Sulfate)	In Water	1	1	-	-	-	-	-	-	-	-	-	-	-	-	-	-	-	-	-	-		
Paraffin (Aliphatic Hydrocarbon)	Varies from Gas to Waxy Solid	1	1	1	X	X	1	X	X	2	X	1	X	1	-	-	2	1	1	-	1		
Paraformaldehyde	White Solid - Flakes or Powder	1	-	-	-	-	2	-	1	2	-	-	-	-	-	1	-	1	1	1	-		
Paraldehyde	Colorless Liquid	1	-	-	-	-	-	-	-	-	-	-	-	-	-	-	-	-	-	-	-		
Paranox (Detergent, Disperser; Exxon)	-	1	-	1	-	-	-	-	-	-	-	-	-	-	-	-	-	-	-	-	-		
Parapol (Liquid Polyisobutylene; Exxon)	Liquid	1	-	-	-	-	-	-	-	-	-	1	-	-	-	-	-	-	-	-	-		
Peanut Oil	Yellow to Green Liquid	1	1	-	2	-	1	-	-	2	X	-	-	-	-	2	1	1	1	1	1		
Pelargonic Acid	Colorless to Yellow Oil	1	-	-	-	-	-	-	-	-	-	-	-	-	-	-	-	-	-	-	-		
Pentachloroethane	Colorless Liquid	1	-	-	-	-	-	-	-	-	-	1	-	-	-	-	-	-	-	-	-		
Pentachlorophenol In Oil	In Oil (Wood Preservative)	1	1	1	X	X	X	X	X	X	1	1	-	-	-	X	-	-	-	-	-		
Pentaerythritol (Monopentaerythritol)	White Powder	-	-	-	-	-	-	-	1	-	-	-	-	-	-	-	-	-	-	-	-		
Pentane	Colorless Liquid	1	X	X	X	X	-	-	-	-	-	1	-	1	-	-	-	-	-	-	-		
Pentanol (Methyl Propyl Carbinol)	Colorless Liquid	1	1	1	1	1	-	-	-	-	1	1	-	1	-	-	-	-	-	-	-		
Pentanone (Methyl Propyl Ketone)	Water White Liquid	1	-	-	-	2	X	-	X	X	2	X	X	-	X	-	-	-	-	-	-		
Pentasol (Amyl alcohols, primary and secondary)	Liquid	1	2	2	2	2	2	2	2	2	2	1	2	1	1	2	1	1	1	1	1		
Perchloric Acid (70%)	70% or Less with H2O	1	2	1	2	-	-	2	2	2	2	1	2	-	X	X	-	2	1	-	1		
Perchloroethylene	Colorless Liquid	1	2	1	X	X	X	X	X	X	X	1	X	2	2	X	1	1	1	-	X		
Petroleum Coke	Solid Pellets	-	-	-	-	-	-	-	1	-	-	-	-	-	-	-	-	-	-	-	-		
Petroleum Distillate	Liquid	1	-	-	-	-	-	-	-	-	-	1	-	-	-	-	-	-	-	-	-		
Petroleum Ether (Naphtha)	Liquid	1	1	-	X	X	2	X	X	X	X	1	X	1	-	X	2	1	1	-	1		
Petroleum Naphtha (Toluene/Cyclohexane/Xylene)	Liquid	1	X	X	X	X	X	X	X	X	X	1	X	X	X	X	-	-	-	-	-		
Petroleum Naphtha Flash Point Over 200 Degrees	Liquid	1	-	-	-	-	-	-	-	-	-	1	-	-	-	-	-	-	-	-	-		
Petroleum Oils (Refined)	Liquid	1	1	1	X	X	1	X	X	2	X	1	2	-	1	1	-	-	-	-	-		
Petroleum Oils (Sour)	Liquid	1	1	1	X	X	1	X	X	2	X	1	X	-	-	2	-	-	-	-	-		
Petroleum Paraffin Wax	Solid with Low Melt Points	1	2	2	X	X	-	-	-	-	-	1	-	-	-	-	-	-	-	-	-		
Phenol (Carbolic Acid)	White or Pink Crystals	1	2	-	2	2	X	X	X	X	2	1	X	1	X	X	X	1	1	2	X		
Phenol Acid	95% or less with H2O	1	2	2	2	2	X	X	X	X	2	1	X	1	X	X	X	1	1	-	X		
Phenolates	-	1	-	-	-	-	X	-	-	X	-	2	X	-	2	-	-	-	-	-	-		
Phenolsulfonic Acid	Yellow to Brown Liquid	1	-	-	-	-	-	-	-	-	-	1	-	-	-	-	-	-	-	-	-		
Phenothiazine	Greenish Powder or Flakes	-	-	-	-	-	-	-	1	-	-	-	-	-	-	-	-	-	-	-	-		
Phenyl Acetate	Water White Liquid	1	-	-	-	-	-	-	-	-	-	-	-	-	-	-	-	-	-	-	-		
Phenyl Chloride (Chlorobenzene)	Clear Volatile Liquid	1	2	-	X	X	X	X	X	X	X	1	X	X	X	X	1	1	1	1	1		

# Chemical Resistance Table

Contact Denver Product Application for recommendations for chemicals not listed.  
Phone (303) 744-5070

- 1 = Preferred - Constant Contact
- 2 = Acceptable - Intermittent Contact
- X = Not Recommended
- = No Data

NOTE: Ratings are for the effect on the polymer only!

Chemical	Form (at room temperature unless otherwise stated)	Gates Hose / Polymers														Couplings / Adapters						
		Chem Master™ Xtreme™ FEP	Chem Master™ Plus XLPE	Chem Master™ Plus UHMWPE	Food & Beverage Master																	
		T	K	L	S	P	C	D	D	A	H	V	M	J	Z	G	Iron/Carbon Steel	Stainless Steel 304	Stainless Steel 316	Aluminum	Brass	Polypropylene
Phenylenediamine (ortho)	Colorless to Red Solid Needles	-	-	-	-	-	-	1	-	-	-	-	-	-	-	-	-	-	-	-	-	-
Phorone (Diisopropylidene Acetone)	Yellow Liquid	1	1	-	-	2	X	X	X	X	2	X	X	-	-	-	1	1	1	-	1	-
Phosgene (Carbonyl Chloride)	Gas, Liquid 60 PSIG @ 120°F (49°C)	1	X	X	X	X	X	X	X	X	2	1	X	-	2	-	-	-	-	-	-	-
Phosphate Ester Hydraulic Fluid	Liquid	1	1	1	-	1	X	X	X	X	2	-	X	-	2	-	-	-	-	-	-	-
Phosphate Rock	Solid	-	-	-	-	-	-	-	1	-	-	-	-	-	-	-	-	-	-	-	-	-
Phosphate, Trisodium	In Water	1	1	1	1	-	-	-	-	-	1	-	-	-	-	-	-	-	-	-	-	-
Phosphoric Acid (100%)	Crystals	1	2	2	2	2	-	-	-	-	1	-	-	-	-	-	-	-	-	-	-	-
Phosphoric Acid (35% or less)	Colorless Liquid	1	1	1	1	1	2	2	2	2	2	1	1	1	-	-	X	1	1	X	2	1
Phosphoric Acid (50%)	Colorless Liquid	1	1	1	1	1	2	2	2	2	2	1	1	1	X	X	X	1	1	X	2	1
Phosphoric Acid (75%)	Colorless Liquid	1	2	1	2	2	-	-	-	-	1	1	1	X	X	X	2	2	X	X	X	1
Phosphoric Acid (85%)	Syrupy Liquid	1	2	1	2	2	X	X	X	X	X	1	1	1	X	X	X	2	2	X	X	1
Phosphoric Acid (90%)	Syrupy Liquid	1	2	1	2	2	-	-	-	-	1	-	-	-	-	-	-	-	-	-	-	-
Phosphoric Acid, Spent	Liquid	1	1	-	-	1	-	-	-	-	1	-	-	-	-	-	-	-	-	-	-	-
Photographic, Developers	-	1	-	-	-	-	-	-	-	-	-	-	-	-	-	-	-	-	-	-	-	-
Photographic, Emulsions	Liquid	1	-	-	-	-	-	-	-	-	-	-	-	-	-	-	-	-	-	-	-	-
Photographic, Fixing Solutions	Liquid	1	-	-	-	-	-	-	-	-	-	-	-	-	1	-	-	-	-	-	-	-
Phthalic Acid	Colorless Crystals	-	-	-	-	-	-	1	-	-	-	-	-	-	-	-	-	-	-	-	-	-
Phthalic Acid (50%)	Colorless Liquid	1	-	1	-	-	-	-	-	-	-	-	-	-	-	-	-	-	-	-	-	-
Phthalic Anhydride, Molten	White Crystalline Solid	-	-	X	-	-	-	-	-	-	-	-	-	-	-	-	-	-	-	-	-	-
Picric Acid (Solution)	In Water	1	2	2	2	2	-	-	-	-	1	-	-	-	-	X	1	1	X	X	1	1
Picric Acid (Trinitrophenol)	Yellow Crystals	1	2	2	2	2	2	2	2	2	2	1	2	-	X	1	X	1	1	X	X	1
Pine Oil	Colorless to Amber Liquid	1	1	-	-	X	2	X	X	-	X	2	X	2	-	-	-	-	-	-	-	-
Pine Tar	Viscous Brown to Black Liquid	1	2	-	-	-	-	-	-	-	1	-	-	-	-	-	-	-	-	-	-	-
Pinene	Colorless Transparent Liquid	1	1	-	X	X	2	X	X	X	X	1	-	2	1	X	1	1	1	-	-	-
Piperazine Hydrochloride Solution (34%)	In Water	1	1	-	-	-	2	-	-	-	-	-	-	-	-	-	-	-	-	-	-	-
Pitch	In Aromatic Hydrocarbons	1	2	X	X	X	2	X	X	X	X	1	X	-	1	X	-	-	-	-	-	-
Plating Solution Chrome (Under 120°F/49°C)	Liquid	1	1	-	-	2	-	-	-	-	2	2	-	-	X	X	-	X	X	-	-	1
Pluronic (Block Polymer with Hydroxyl by BASF)	Liquid	1	1	1	1	1	-	-	-	-	1	-	-	-	-	-	-	-	-	-	-	-
Polyester Plastic	-	1	1	-	-	-	-	-	-	-	2	-	-	2	-	-	-	-	-	-	-	-
Polyethylene Glycol	Colorless Liquid to Glassy Solid	1	-	-	-	1	2	-	1	1	1	1	1	-	2	2	-	-	-	-	-	-
Polyethylene Plastic	Solid Beads	-	-	-	-	-	-	1	-	-	-	-	-	-	-	-	-	-	-	-	-	-
Polypropylene Glycol	Liquid	1	1	-	1	1	1	-	1	1	1	1	1	-	-	-	-	-	-	-	-	-
Polypropylene Plastic	Solid Beads	-	-	-	-	-	-	-	1	-	-	-	-	-	-	-	-	-	-	-	-	-
Polystyrene Plastic	Solid Beads	-	-	-	-	-	-	1	-	-	-	-	-	-	-	-	-	-	-	-	-	-
Polyurethane Foam (Under 125°F/52°C)	-	1	1	-	-	2	-	-	-	-	2	2	-	-	-	-	-	-	-	-	-	-
Polyvinyl Acetate - Emulsions	Emulsion	1	1	1	1	1	1	-	1	2	1	-	1	1	-	1	-	-	-	-	-	-
Potash (Potassium Carbonate) Aqueous Solution	Liquid	1	1	-	1	1	-	1	1	1	1	1	1	-	1	1	2	1	1	-	X	1
Potassium Acetate	White Powder	1	1	-	-	2	2	2	2	2	2	X	2	1	-	1	-	1	1	-	-	1
Potassium Bicarbonate	Colorless Crystal or White Powder	1	1	-	-	1	1	1	1	1	1	1	1	-	1	1	-	-	-	-	-	-
Potassium Bisulfate	Colorless Crystal	1	1	-	-	1	1	1	1	1	1	1	1	-	1	-	-	-	-	-	-	-
Potassium Bromate	White Crystal or Powder	1	-	-	-	-	-	-	-	-	-	-	-	-	-	1	-	-	-	-	-	1
Potassium Bromide	White Crystals or Powder	1	1	-	-	1	1	1	1	1	1	1	1	-	1	1	-	-	-	-	-	-
Potassium Carbonate	White Granular Powder	1	1	-	-	1	1	1	1	1	1	1	1	1	1	1	2	1	1	-	X	1
Potassium Carbonate, Liquid	Colorless to Cloudy Liquid	1	1	-	1	1	1	1	1	1	1	1	1	-	1	1	2	1	1	-	X	1
Potassium Chlorate	Colorless to White Powder	1	-	-	-	-	-	-	-	-	-	-	-	2	1	-	-	-	-	-	-	-
Potassium Chloride	Colorless to White Solid	1	-	-	-	-	-	-	-	-	-	-	1	1	1	-	-	-	-	-	-	-
Potassium Chloride, Dry	White Solid	1	1	-	1	1	1	1	1	1	1	1	1	-	1	1	-	-	-	-	-	-
Potassium Chromate	Yellow Crystal	1	2	-	-	2	X	X	X	2	2	1	2	1	2	1	-	-	-	-	-	1

AGRICULTURE

AIR BREATHING

AIR DUCT

AIR AND MULTI-PURPOSE

CHEMICAL

FOOD AND BEVERAGE

MARINE AND ENGINE

MATERIAL HANDLING

MINING

OILFIELD

PETROLEUM

PRESSURE WASH AND WASHDOWN

STEAM

WATER

CLAMPS

COUPLINGS AND FERRULES

HOSE FINDER

CHEMICAL RESISTANCE TABLE

# Chemical Resistance Table

AGRICULTURE
AIR BREATHING
AIR DUCT
AIR AND MULTI-PURPOSE
CHEMICAL
FOOD AND BEVERAGE
MARINE AND ENGINE
MATERIAL HANDLING
MINING
OILFIELD
PETROLEUM
PRESSURE WASH AND WASHDOWN
STEAM
WATER
CLAMPS
COUPLINGS AND FERRULES
HOSE FINDER
CHEMICAL RESISTANCE TABLE

Contact Denver Product Application for recommendations for chemicals not listed.  
Phone (303) 744-5070

1 = Preferred - Constant Contact  
2 = Acceptable - Intermittent Contact  
X = Not Recommended  
- = No Data

NOTE: Ratings are for the effect on the polymer only!

Chemical	Form (at room temperature unless otherwise stated)	Gates Hose / Polymers																Couplings / Adapters				
		Chem Master™ Xtreme™ FEP	Chem Master™ Plus XLPE	Chem Master™ Plus UHMWPE	Sanitron™ Food & Beverage Master	EPDM	NR	SBR	NR	Chloroprene	Butyl	Fluorocarbon	Hypalon®	CPE	Nylon	PVC	Iron/Carbon Steel	Stainless Steel 304	Stainless Steel 316	Aluminum	Brass	Polypropylene
Potassium Cuprocyanide	White Crystalline Solid	1	-	-	-	1	1	1	1	1	1	1	1	1	1	-	-	-	-	-	-	1
Potassium Cyanide	White Crystal	1	-	-	-	-	-	-	-	-	-	-	-	1	-	-	-	-	-	-	-	-
Potassium Dichromate	White Crystalline Powder	1	-	-	-	-	-	-	-	-	-	-	1	2	1	-	-	-	-	-	-	-
Potassium Ferrocyanide	Yellow Crystal or Powder	1	-	-	-	-	-	-	-	-	-	-	-	-	1	-	-	-	-	-	-	1
Potassium Fluoride	White Crystalline Powder	1	-	-	-	-	-	-	-	-	-	-	-	-	1	-	-	-	-	-	-	1
Potassium Hydrate	White Solid	1	-	-	-	2	2	2	2	2	1	X	1	-	2	2	-	-	-	-	-	-
Potassium Hydroxide (45% Caustic Potash)	Colorless to Cloudy Liquid	1	1	1	1	2	2	2	2	2	1	2	-	X	2	2	-	-	-	-	-	-
Potassium Hydroxide, Liquid >50%	Colorless to Cloudy Liquid	1	1	-	-	1	2	2	2	2	1	X	2	X	X	2	-	-	-	-	-	-
Potassium Iodide	White Solid	1	-	-	-	1	1	-	-	1	-	1	1	-	-	1	-	-	-	-	-	2
Potassium Nitrate	Colorless to White Solid	1	-	-	-	-	-	-	-	-	-	-	-	1	1	1	-	-	-	-	-	-
Potassium Permanganate	Dark Purple Crystal	1	1	-	-	-	-	-	-	-	-	-	-	X	X	-	-	-	-	-	-	-
Potassium Persulfate	White Crystal	1	-	-	-	-	-	-	-	-	-	-	-	-	1	-	-	-	-	-	-	-
Potassium Phosphate	Colorless to White Crystal	1	-	-	-	1	-	-	-	1	-	1	1	-	-	-	-	-	-	-	-	-
Potassium Silicate, Other Than Dry	-	1	1	-	-	1	1	2	-	1	-	1	-	-	-	-	-	-	-	-	-	-
Potassium Sulfate	White Crystal or Powder	1	-	-	1	-	-	-	-	-	-	-	-	1	1	1	-	-	-	-	-	-
Potassium Sulfide	Red or Yellow Crystal or Solid	1	1	-	-	1	1	-	-	1	1	1	2	-	-	-	-	-	-	-	-	-
Potassium Sulfite	White Crystal or Powder	1	-	-	-	-	-	-	-	-	-	-	-	1	-	2	-	-	-	-	-	-
Potassium Thiosulfate	Colorless Crystal	1	-	-	-	1	-	-	-	1	-	1	1	-	-	1	-	-	-	-	-	-
Primatol A, S, P (Ag Spray)	Liquid	1	-	-	-	-	-	-	-	-	-	-	-	-	-	-	-	-	-	-	-	-
Propane Gas	Colorless Gas	CONTACT DENVER PRODUCT APPLICATION																				
Propanediol	Colorless Liquid	1	1	-	-	1	1	-	-	X	1	1	2	-	-	-	-	-	-	-	-	-
Propanol (Propyl Alcohol)	Colorless Liquid	1	1	1	1	1	-	-	-	-	1	1	-	1	1	2	-	-	-	-	-	-
Propionic Acid	Colorless Oily Liquid	1	1	1	1	2	X	2	2	X	2	1	2	-	-	-	1	1	-	-	-	-
Propyl Acetate	Colorless Liquid	1	1	1	1	-	-	-	-	-	X	-	2	-	-	-	-	-	-	-	-	-
Propyl Alcohol (Propanol)	Colorless Liquid	1	1	1	1	1	-	-	-	-	1	1	-	1	1	2	-	-	-	-	-	-
Propyl Aldehyde	White Water Liquid	1	-	-	-	-	X	-	X	-	2	X	X	-	-	-	-	-	-	-	-	-
Propyl Chloride	Colorless Liquid	1	-	-	-	-	X	-	X	-	X	2	X	-	-	-	-	-	-	-	-	-
Propylene	Colorless Gas	1	-	-	-	X	X	X	X	X	X	1	X	-	-	-	-	-	-	-	-	-
Propylene Diamine	Colorless Liquid	1	-	-	-	-	2	-	2	-	2	-	X	-	-	-	-	-	-	-	-	-
Propylene Dichloride (Dichloropropane)	Colorless Liquid	1	-	-	-	X	X	X	X	X	X	2	X	-	-	-	-	-	-	-	-	-
Propylene Glycol	Liquid	1	1	-	1	1	1	1	1	1	1	1	1	1	2	1	-	-	-	-	-	-
Propylene Oxide	Colorless Liquid	-	-	-	-	-	-	-	-	-	-	-	1	-	-	-	-	-	-	-	-	-
Purina Insecticide	-	1	1	-	-	2	X	-	-	X	2	2	-	-	2	-	1	1	1	1	2	-
Puropale RX Oils	Liquid	1	1	-	-	X	1	-	-	-	X	-	-	-	1	2	1	1	1	1	1	-
Pydraut 10E, 29E-LT, 30E, 60, 65E, 115SE	Liquid	1	1	-	-	2	X	-	-	-	2	-	-	2	-	X	1	1	1	1	1	-
Pydraut 135	Liquid	1	1	-	-	-	X	-	-	-	2	1	-	2	2	-	1	1	1	-	-	-
Pydraut 150	Liquid	1	1	-	-	2	X	X	X	X	2	1	X	2	2	X	1	1	1	1	1	-
Pydraut 280	Liquid	1	1	-	-	2	X	X	X	X	2	2	X	2	2	X	1	1	1	-	-	-
Pydraut 312	Liquid	1	1	-	2	X	X	X	X	X	X	1	-	2	1	X	1	1	1	-	-	-
Pydraut 50E	Liquid	1	1	-	-	2	-	-	-	-	2	2	-	2	1	X	-	-	-	-	-	-
Pydraut 540	Liquid	1	1	-	-	X	X	X	X	X	X	1	X	2	X	X	1	1	1	-	-	-
Pydraut 625	Liquid	1	1	-	-	2	X	X	X	X	2	1	X	2	2	X	1	1	1	-	-	-
Pydraut A-200	Liquid	1	1	-	-	X	X	X	X	X	X	1	X	2	2	X	1	1	1	-	-	-
Pydraut F-9	Liquid	1	2	-	-	2	X	X	X	X	2	1	X	2	2	-	1	1	1	-	-	-
Pyrene (Carbon Tetrachloride)	Colorless Liquid	1	2	X	X	X	X	X	X	X	X	1	X	2	1	X	X	2	2	X	2	X
Pyrethrum	Liquid	1	-	-	-	-	-	-	-	-	-	-	-	-	2	-	-	-	-	-	-	-
Pyridine (50%)	-	1	2	-	2	-	-	-	-	X	-	X	X	-	-	X	-	1	1	1	1	-
Pyrogard 160, 230, 630	Liquid	1	1	-	-	-	-	-	-	-	-	2	-	-	-	-	1	1	1	-	-	-

# Chemical Resistance Table

Contact Denver Product Application for recommendations for chemicals not listed.  
Phone (303) 744-5070

1 = Preferred - Constant Contact  
2 = Acceptable - Intermittent Contact  
X = Not Recommended  
- = No Data

NOTE: Ratings are for the effect on the polymer only!

Chemical	Form (at room temperature unless otherwise stated)	Gates Hose / Polymers														Couplings / Adapters					
		Chem Master™XTreme™ FEP	Chem Master™ Plus XLPE	Chem Master™ Plus UHMWPE	Food & Beverage Master																
		T	K	L	S	P	C	D	D	A	H	V	M	J	Z	G	Iron/Carbon Steel	Stainless Steel 304	Stainless Steel 316	Aluminum	Brass
Pyrogard 51, 53, 55	Liquid	1	-	-	-	2	X	-	-	2	-	-	-	-	-	-	1	1	1	-	-
Pyrogard C, D	Liquid	1	1	-	-	X	1	-	-	-	-	X	-	-	1	2	1	1	1	1	1
Pyronal (Transformer Oil)	Liquid	1	1	-	-	-	-	-	-	-	-	1	-	-	-	-	-	-	-	-	-
<b>Q</b>																					
Quenching Oil	Liquid	1	-	-	-	2	-	-	2	-	-	-	-	-	-	-	1	1	1	1	-
Quintolubric 822	Liquid	1	1	-	-	2	1	-	-	2	X	1	-	-	1	-	1	1	1	1	1
<b>R</b>																					
Ramrod (Ag Spray)	-	1	1	-	-	-	-	-	-	-	-	-	-	1	-	1	1	1	1	1	1
Rando Oils	Liquid	1	1	-	-	X	1	-	-	X	-	-	-	1	-	1	1	1	1	1	1
Rape Seed Oil (Canola Oil)	Brownish to yellow Liquid	1	1	-	2	2	2	-	-	2	2	-	X	2	2	2	2	2	2	1	1
Red Oil (Commercial Oleic Acid) (MIL-5606)	Liquid	1	2	2	2	2	1	X	X	2	2	2	X	2	1	2	2	2	1	1	2
Refined Wax (Petroleum)	-	1	1	-	-	1	X	X	2	-	1	-	-	1	-	1	1	1	-	1	-
Regal Oils R&O	Liquid	1	1	-	-	X	1	-	-	X	-	-	-	1	2	1	1	1	1	1	1
Richfield "A" Weed Killer	-	1	1	-	-	X	2	X	X	X	X	2	X	-	-	2	-	-	-	-	-
Road Paving Compound	-	-	-	X	-	-	-	-	-	-	-	-	-	-	-	-	-	-	-	-	-
Road Tar	-	-	-	2	-	-	-	-	-	-	-	-	-	-	-	-	-	-	-	-	-
Round Up (Glyphosate)	-	-	-	-	1	-	-	-	-	-	-	-	-	1	-	-	-	-	-	-	-
Rubilene Oils	Liquid	1	1	-	-	X	1	-	-	X	-	-	-	1	2	-	-	-	-	-	-
<b>S</b>																					
Salicytic Acid	White Powder	1	1	1	1	2	X	2	2	-	2	2	-	1	1	-	1	1	2	-	-
Salt Water (Sea Water)	Liquid	1	1	-	1	1	2	2	X	2	1	1	2	-	1	1	2	1	1	-	2
Sauerkraut	-	1	-	-	1	-	-	-	-	-	-	-	-	-	2	-	-	-	-	-	-
Sea Water	Colorless Liquid	1	1	-	1	1	2	2	X	2	1	1	2	-	1	1	2	1	1	-	2
Sevin	-	1	2	-	2	-	-	-	-	-	-	-	-	1	-	-	-	-	-	-	-
Sewage	Sludge	1	1	1	1	1	2	2	X	2	-	-	2	1	1	2	X	1	1	2	1
Shampoo	Liquid	1	-	1	-	-	-	-	-	-	-	-	-	-	-	-	-	-	-	-	-
Shellac	Orange to Colorless Flake	1	-	X	-	-	-	-	-	-	-	-	-	-	1	-	-	-	-	-	-
Shortening	-	1	-	-	X	1	-	-	-	-	-	-	-	-	-	-	-	-	-	-	-
Silicate of Soda	Brownish or Yellow Liquid	1	1	-	-	1	1	-	1	1	1	1	1	-	-	-	-	-	-	-	-
Silicone Greases	Liquid	1	2	-	-	2	-	-	2	-	2	2	-	1	2	1	1	1	-	1	-
Silicone Oils	Liquid	1	2	-	-	2	-	-	2	-	2	2	-	1	2	1	1	1	-	1	-
Silver Cyanide	White Powder	1	1	-	-	-	-	-	1	-	-	-	-	-	1	-	-	-	-	-	1
Silver Nitrate	Colorless Crystal	1	1	-	-	1	1	1	1	1	1	1	1	1	2	2	1	1	1	2	-
Skydrol 500A & 7000	Liquid	1	1	-	1	1	X	X	X	X	2	X	X	2	1	X	1	1	1	1	-
Soap Oil	Liquid	1	1	2	-	X	-	-	X	-	-	X	-	-	-	1	1	1	-	-	-
Soap Solutions	Liquid	1	1	1	-	1	1	X	X	2	1	1	1	1	1	1	1	1	1	1	1
Soap, Liquid	Liquid	1	1	-	-	1	1	2	2	1	2	1	1	-	2	2	1	1	-	-	-
Soda Ash (Sodium Carbonate)	Grayish Powder	1	1	-	-	1	1	1	1	1	1	1	1	1	1	1	1	1	1	X	2
Soda Water	Liquid	1	-	-	-	-	-	-	-	-	-	-	-	1	1	-	-	-	-	-	-
Sodium Acetate	Colorless Crystal	1	1	-	-	2	X	2	2	X	2	X	X	1	1	1	1	1	1	1	1
Sodium Aluminate Solution	Colorless to Cloudy Liquid	1	1	-	-	1	1	2	2	1	1	1	1	-	2	2	-	-	-	-	-
Sodium Benzoate	White Crystals or Powder	1	-	-	-	-	-	-	-	-	-	-	-	-	1	-	-	-	-	-	1
Sodium Bicarbonate	White Crystal or Powder	1	1	-	-	1	1	1	1	1	1	1	1	1	1	1	2	1	1	-	2
Sodium Bichromate Solution	Red to Clear Liquid	1	1	-	-	1	2	2	2	2	1	1	2	-	2	2	-	-	-	-	-
Sodium Bisulfate (Niter Cake)	Colorless Crystals to White Lumps	1	1	-	-	1	1	1	1	1	1	1	1	X	1	1	X	1	1	X	X
Sodium Bisulfite	White Crystals or Powder	1	1	-	-	1	1	1	1	1	1	1	1	-	1	1	1	1	1	-	-
Sodium Borate (Borax)	White Crystals	1	1	-	-	1	1	1	1	1	1	1	1	-	1	1	2	1	1	-	2
Sodium Carbonate (Soda Ash)	Grayish Powder	1	1	-	-	1	1	1	1	1	1	1	1	1	1	1	1	1	1	X	2

AGRICULTURE

AIR BREATHING

AIR DUCT

AIR AND MULTI-PURPOSE

CHEMICAL

FOOD AND BEVERAGE

MARINE AND ENGINE

MATERIAL HANDLING

MINING

OILFIELD

PETROLEUM

PRESSURE WASH AND WASHDOWN

STEAM

WATER

CLAMPS

COUPLINGS AND FERRULES

HOSE FINDER

CHEMICAL RESISTANCE TABLE

# Chemical Resistance Table

AGRICULTURE

AIR BREATHING

AIR DUCT

AIR AND MULTI-PURPOSE

CHEMICAL

FOOD AND BEVERAGE

MARINE AND ENGINE

MATERIAL HANDLING

MINING

OILFIELD

PETROLEUM

PRESSURE WASH AND WASHDOWN

STEAM

WATER

CLAMPS

COUPLINGS AND FERRULES

HOSE FINDER

CHEMICAL RESISTANCE TABLE

Contact Denver Product Application for recommendations for chemicals not listed.  
Phone (303) 744-5070

1 = Preferred - Constant Contact  
2 = Acceptable - Intermittent Contact  
X = Not Recommended  
- = No Data

NOTE: Ratings are for the effect on the polymer only!

Chemical	Form (at room temperature unless otherwise stated)	Gates Hose / Polymers														Couplings / Adapters						
		Chem Master™ Xtreme™ FEP	Chem Master™ Plus XLPE	Chem Master™ Plus UHMWPE	Sanitron™ Food & Beverage Master	EPDM	NR	SBR	NR	Chloroprene	Butyl	Fluorocarbon	Hypalon®	CPE	Nylon	PVC	Iron/Carbon Steel	Stainless Steel 304	Stainless Steel 316	Aluminum	Brass	Polypropylene
		T	K	L	S	P	C	D	D	A	H	V	M	J	Z	G						
Sodium Chlorate	Colorless Crystals	1	-	-	-	1	1	1	1	1	1	1	1	1	1	1	2	2	1	X	X	-
Sodium Chloride	Colorless to White Crystals	1	1	1	1	1	1	1	1	1	1	1	1	1	1	1	2	2	1	X	X	-
Sodium Chlorite Solution	Colorless to Cloudy Liquid	2	-	-	-	X	X	2	2	X	2	X	2	-	X	2	-	-	-	-	-	-
Sodium Chromate	Yellow, Translucent Crystals	1	-	-	-	-	1	2	2	1	2	1	X	-	2	2	-	-	-	-	-	-
Sodium Cyanide	In Water	1	1	-	-	1	1	1	1	1	1	1	2	1	1	2	1	1	X	X	-	-
Sodium Cyanide	White Crystalline Powder	1	1	-	-	1	1	1	1	1	1	1	2	1	1	2	1	1	X	X	-	-
Sodium Dichromate	Red to Red-Orange Crystals	1	-	-	-	1	1	2	2	2	1	1	2	-	-	1	-	-	-	-	-	1
Sodium Ferricyanide	Ruby-Red Crystals	1	-	-	-	-	-	-	-	-	-	-	-	-	-	1	-	-	-	-	-	1
Sodium Ferrocyanide	Yellow, Transparent Crystals	1	-	-	-	-	-	-	-	-	-	-	-	-	-	1	-	-	-	-	-	1
Sodium Fluoride (70%)	White Liquid	1	1	1	-	2	-	2	2	-	2	-	-	-	-	1	-	-	2	-	-	-
Sodium Hydrate	White Solid	1	2	-	-	1	2	2	2	2	2	2	-	2	2	-	-	-	-	-	-	-
Sodium Hydrochlorite	Pale Greenish Liquid	1	2	-	-	2	X	2	X	X	2	1	1	-	2	2	-	-	-	-	-	-
Sodium Hydrosulfide	Colorless Needles	1	-	-	-	-	-	-	-	-	-	-	-	-	1	-	-	-	-	-	-	-
Sodium Hydrosulfite	Lemon Colored Powder or Flake	1	-	-	-	-	-	-	-	-	-	-	-	-	2	-	-	-	-	-	-	-
Sodium Hydroxide (10%)	Colorless Liquid	1	1	1	1	-	-	-	-	-	-	1	-	1	-	-	-	-	-	-	-	-
Sodium Hydroxide (40%)	Colorless Liquid	1	1	1	1	2	2	1	1	1	2	1	1	X	-	2	1	1	X	X	-	-
Sodium Hydroxide (50%) (Under 212°F/100°C)	Colorless Liquid	1	1	2	1	2	-	-	-	-	X	-	1	-	-	-	-	-	-	-	-	-
Sodium Hydroxide (50%) (Under 115°F/46°C)	Colorless Liquid	1	1	2	1	2	X	1	1	2	1	X	1	1	X	-	2	2	2	X	X	-
Sodium Hydroxide (50%) (Under 180°F/82°C)	Colorless Liquid	1	1	2	1	2	X	X	X	2	2	X	2	1	X	-	X	2	2	X	X	-
Sodium Hydroxide (60%)	White Liquid	1	2	1	-	2	X	2	2	2	2	X	2	1	X	-	X	2	2	X	X	-
Sodium Hydroxide (25%)	Colorless Liquid	1	1	1	1	2	2	1	1	1	2	1	1	1	-	-	X	X	2	X	X	-
Sodium Hypochlorite (20%)	White Liquid	1	2	1	-	1	X	X	X	X	-	X	1	1	2	1	X	X	2	X	X	-
Sodium Hypochlorite (5%)	White Liquid	1	2	1	-	1	X	X	X	-	-	1	1	1	1	1	X	X	2	X	X	-
Sodium Hyposulfate	Large, Transparent Crystals	1	-	-	-	-	-	-	-	-	-	-	-	-	1	-	-	-	-	-	-	-
Sodium Metallic	Silver Solid	2	-	-	-	1	2	-	-	-	-	-	-	-	-	-	-	-	-	-	-	-
Sodium Metaphosphate	Colorless Crystals to White Powder	1	1	-	-	2	2	2	2	2	2	2	2	1	1	1	X	1	1	1	X	-
Sodium Nitrate	Colorless Crystal	1	1	-	-	2	X	X	X	X	2	-	2	1	1	1	2	2	2	2	2	-
Sodium Perborate	White, Amorphous Powder	1	1	-	-	2	X	X	X	X	2	-	X	X	2	-	X	1	1	1	X	-
Sodium Peroxide	Yellowish White Powder	1	1	2	-	-	-	-	1	1	1	1	X	X	1	X	1	1	1	X	-	-
Sodium Phosphate	Colorless Crystals to White Powder	1	1	-	-	2	-	2	2	X	2	-	-	X	1	1	-	1	1	X	X	-
Sodium Silicate	Lumps of Greenish Glass	1	1	-	1	1	1	1	1	1	1	1	1	1	1	-	-	-	-	-	-	1
Sodium Sulfate	White Crystals or Powder	1	1	-	-	1	1	2	2	1	1	1	1	1	1	1	-	-	-	-	-	1
Sodium Sulfate Decahydrate (Glauber's Salt)	Crystals or Powder	1	-	-	-	1	-	1	1	-	-	-	-	-	-	-	-	-	-	-	-	-
Sodium Sulfhydrate	Colorless to Cloudy Liquid	1	2	-	-	1	2	X	2	2	2	2	2	-	2	2	-	-	-	-	-	-
Sodium Sulfide	Yellow/Brick Red Flakes or Crystals	1	1	-	-	1	1	2	2	1	1	1	1	2	1	1	-	-	-	-	-	1
Sodium Sulfide Solution	Colorless to Cloudy Liquid	1	2	-	-	1	2	-	2	2	1	2	2	2	X	-	-	-	-	-	-	1
Sodium Sulfite	White Crystals or Powder	1	1	-	-	2	2	2	2	2	2	-	2	-	1	1	1	1	1	-	-	-
Sodium Sulfite Solution	Colorless to Cloudy Liquid	1	2	-	-	1	2	-	2	2	1	2	2	-	X	-	1	1	1	-	-	-
Sodium Sulphhydrate	Colorless Needles	1	2	-	-	1	2	-	-	2	1	2	2	-	2	2	-	-	-	-	-	-
Sodium Thiocyanate Solution	Colorless to Cloudy Liquid	1	1	-	-	1	1	2	-	1	2	1	2	-	-	-	-	-	-	-	-	-
Sodium Thiosulfate (HPO)	White Powder	1	1	-	-	-	1	1	1	1	1	-	1	1	1	X	1	1	2	X	-	-
Sodium Tripolyphosphate (STPP)	White Powder	1	2	-	-	-	-	-	-	-	2	X	-	-	-	-	-	1	1	X	X	-
Solnus Oils	Liquid	1	1	-	-	X	1	-	-	-	X	-	-	-	1	1	1	1	1	1	1	-
Sour Crude Oil	Liquid	-	-	-	-	-	-	-	-	-	-	-	-	-	X	-	-	-	-	-	-	-
Soybean Oil	Pale Yellow Oil	1	1	1	2	X	2	X	X	2	2	1	2	2	1	2	1	1	1	-	-	-
Spent Acid	Liquid	1	2	2	X	X	X	X	X	X	X	1	2	X	X	X	-	1	1	-	-	-
Stannic Chloride	Colorless, Fuming Liquid	1	1	-	-	-	2	2	2	X	X	1	X	X	X	2	X	-	-	-	X	-
Stannic Sulfide	Yellow to Brown Powder	1	2	-	-	-	2	-	2	-	2	-	2	-	-	-	-	-	-	-	-	-

# Chemical Resistance Table

Contact Denver Product Application for recommendations for chemicals not listed.  
Phone (303) 744-5070

1 = Preferred - Constant Contact  
2 = Acceptable - Intermittent Contact  
X = Not Recommended  
- = No Data

NOTE: Ratings are for the effect on the polymer only!

Chemical	Form (at room temperature unless otherwise stated)	Gates Hose / Polymers														Couplings / Adapters						
		Chem Master™ Xtreme™ FEP	Chem Master™ Plus XLPE	Chem Master™ Plus UHMWPE	Sanitron™ Food & Beverage Master	EPDM	NR	SBR	NR	Chloroprene	Butyl	Fluorocarbon	Hypalon®	CPE	Nylon	PVC	Iron/Carbon Steel	Stainless Steel 304	Stainless Steel 316	Aluminum	Brass	Polypropylene
		T	K	L	S	P	C	D	D	A	H	V	M	J	Z	G						
Stannous Chloride (Under 150°F)	White Mass	1	1	-	-	2	1	1	1	1	1	1	1	X	1	-	-	-	-	-	-	1
Starch	White Amorphous Powder	1	1	-	1	2	1	1	2	-	1	1	-	1	1	-	1	1	-	-	-	-
Starch Gum (Dextrin)	Yellow or White Powder	1	1	-	-	1	1	-	-	1	X	1	-	-	1	1	-	1	1	-	-	1
Stauffer Jet 1	Liquid	1	1	-	-	-	-	-	-	-	-	-	-	-	-	-	1	1	1	1	1	-
Stauffer Jet 2	Liquid	1	1	-	-	-	-	-	-	-	-	-	-	-	-	-	1	1	1	1	1	-
Steam	Gas	USE STEAM HOSE ONLY														-	-	-	-	-	-	-
Stearic Acid (Octadecanoic Acid)	Colorless Waxy Solid	1	1	1	1	2	2	2	2	2	2	1	2	1	1	1	X	2	1	X	X	-
Stearin	Colorless crystal or Powder	1	-	-	-	-	-	-	-	-	-	-	-	-	2	-	-	-	-	-	-	-
Stoddard Solvent	Clear petroleum distillate	1	2	-	2	X	2	X	X	-	X	1	-	1	1	2	2	1	1	-	1	-
STPP (Sodium Tripolyphosphate)	White Powder	1	2	-	-	2	-	2	2	-	2	X	-	-	-	-	2	1	X	X	-	-
Straight Synthetic Oils	Liquid	1	-	-	-	-	-	-	-	-	-	-	-	1	2	-	-	-	-	-	-	-
Styrene (Monomer)	Colorless Oily Liquid	1	2	-	X	X	X	X	X	-	X	2	-	2	2	-	2	X	2	X	2	-
Sucrose Solutions	Liquid	1	1	-	1	-	1	1	1	1	1	-	1	-	-	-	1	1	1	-	-	-
Sugar, Liquid, Blended	Liquid	1	1	-	1	1	1	1	1	1	1	1	2	-	-	-	-	-	-	-	-	-
Sugar, Syrup	Liquid	1	1	-	1	1	1	1	1	1	1	2	-	-	-	-	-	-	-	-	-	-
Sulfamic Acid	In Water	1	1	1	1	2	X	X	X	X	-	2	1	2	1	X	X	-	-	-	-	-
Sulfamic Acid (10%) (Under 170°F/77°C)	Colorless Liquid	1	X	-	-	-	-	X	X	-	2	2	1	-	-	-	-	-	-	-	-	-
Sulfate Liquors (Under 150°F/66°C)	-	1	-	-	-	-	-	-	-	-	-	-	-	1	1	-	-	-	-	-	-	1
Sulfur (Under 200°F/93°C)	Yellow Crystals	-	-	-	-	-	-	-	-	-	-	-	-	-	-	-	-	-	-	-	-	-
Sulfur Chloride	Yellow Oily Liquid	1	2	-	-	X	X	X	X	X	X	1	2	-	2	2	X	X	2	-	X	-
Sulfur Dioxide	Colorless Gas or Liquid	-	-	-	1	2	X	X	-	-	2	X	-	-	-	-	-	-	-	-	-	-
Sulfur Dioxide (Dry)	-	1	2	-	-	2	X	X	X	X	X	1	2	-	X	1	2	1	1	1	1	-
Sulfur Dioxide (Liquid)	Colorless Liquid	1	-	1	-	1	X	X	X	2	2	X	2	-	-	X	-	-	-	-	-	-
Sulfur Dioxide (Moist)	-	1	-	1	-	1	X	X	X	2	1	2	2	-	-	X	-	-	-	-	-	-
Sulfur Hexafluoride (Gas)	Colorless Gas	1	1	-	-	1	2	2	2	1	2	2	-	1	2	-	-	-	-	-	-	-
Sulfur Trioxide (Dry)	Solid	1	2	-	-	2	X	X	X	X	X	1	X	X	-	1	2	2	2	2	-	-
Sulfuric Acid (10%)	Colorless Water Solution	1	1	1	1	1	2	1	1	1	1	1	1	1	X	-	-	X	X	2	X	X
Sulfuric Acid (100%)	Colorless Liquid	1	X	X	X	X	X	X	X	X	X	2	X	X	-	-	2	X	2	X	X	-
Sulfuric Acid (30%)	Colorless Water Solution	1	1	1	1	1	2	2	2	1	1	1	1	1	X	-	X	X	2	X	X	-
Sulfuric Acid (50%)	Colorless Water Solution	1	1	1	1	1	X	X	X	2	1	1	1	1	X	-	X	X	2	X	X	-
Sulfuric Acid (60%)(48.5 deg Baume)	Colorless Liquid	1	1	1	1	1	X	X	X	X	1	1	1	1	X	-	X	X	2	X	X	-
Sulfuric Acid (75%)	Colorless to Brown Solution	1	1	1	1	2	X	X	X	X	X	1	2	2	X	-	X	X	2	X	X	-
Sulfuric Acid (88%) (64.7 deg Baume)	Colorless Liquid	1	2	1	2	X	X	X	X	X	X	1	X	X	X	-	X	X	2	X	X	-
Sulfuric Acid (93%)	Colorless to Brown Oily Liquid	1	X	1	2	X	X	X	X	X	X	1	X	X	X	-	X	X	2	X	X	-
Sulfuric Acid (96%)	Colorless Liquid	1	X	1	2	X	X	X	X	X	X	1	X	X	X	-	X	X	2	X	X	-
Sulfuric Acid (98%)	Colorless to Brown Oily Liquid	1	X	1	2	X	X	X	X	X	X	1	X	X	X	-	X	X	2	X	X	-
Sulfuric Acid, Fuming (Oleum)	Colorless to Dark Brown Oily Liquid	1	X	X	X	X	X	X	X	X	X	1	X	X	X	X	-	-	1	-	-	X
Sulfurous Acid (10%)	Colorless Liquid	1	1	1	1	1	X	X	X	-	2	1	1	1	-	1	-	X	2	1	X	X
Sulfurous Acid (75%)	Colorless Liquid	1	1	1	1	1	X	X	X	X	X	1	1	1	X	-	X	X	2	X	X	-
Sun R&O Oils	Liquid	1	1	-	-	X	1	-	-	-	X	1	-	-	1	2	1	1	1	1	1	-
Suntac HP Oils	Liquid	1	1	-	-	X	1	-	-	-	X	1	-	-	1	2	1	1	1	1	1	-
Suntac WR Oils	Liquid	1	1	-	-	X	1	-	-	-	X	1	-	-	1	2	1	-	1	1	-	-
Sunvis Oils 700, 800, 900	Liquid	1	1	-	-	X	1	-	-	-	X	1	-	-	1	2	1	1	1	1	-	-
Synthetic Oil (Citgo)	Liquid	1	1	-	-	X	-	-	-	-	X	-	-	-	1	2	1	1	1	1	-	-
Syrup Viscous	Liquid	1	1	-	1	-	-	1	1	2	-	1	-	-	-	-	-	1	1	-	-	-
<b>T</b>																						
TEL (Tetraethyl Lead)	Colorless Oily Liquid	1	2	-	-	X	2	X	X	X	X	1	X	-	2	1	-	-	-	-	-	-
Tellus Oils	Liquid	1	1	-	-	X	1	-	-	-	X	1	-	-	1	2	1	1	1	1	1	-

AGRICULTURE

AIR BREATHING

AIR DUCT

AIR AND MULTI-PURPOSE

CHEMICAL

FOOD AND BEVERAGE

MARINE AND ENGINE

MATERIAL HANDLING

MINING

OILFIELD

PETROLEUM

PRESSURE WASH AND WASHDOWN

STEAM

WATER

CLAMPS

COUPLINGS AND FERRULES

HOSE FINDER

CHEMICAL RESISTANCE TABLE

# Chemical Resistance Table

AGRICULTURE
AIR BREATHING
AIR DUCT
AIR AND MULTI-PURPOSE
CHEMICAL
FOOD AND BEVERAGE
MARINE AND ENGINE
MATERIAL HANDLING
MINING
OILFIELD
PETROLEUM
PRESSURE WASH AND WASHDOWN
STEAM
WATER
CLAMPS
COUPLINGS AND FERRULES
HOSE FINDER
CHEMICAL RESISTANCE TABLE

Contact Denver Product Application for recommendations for chemicals not listed.  
Phone (303) 744-5070

1 = Preferred - Constant Contact  
2 = Acceptable - Intermittent Contact  
X = Not Recommended  
- = No Data

NOTE: Ratings are for the effect on the polymer only!

Chemical	Form (at room temperature unless otherwise stated)	Gates Hose / Polymers																Couplings / Adapters				
		Chem Master™ Xtreme™ FFP	Chem Master™ Plus XLPE	Chem Master™ Plus UHMWPE	Sanitron™ Food & Beverage Master	EPDM	NR	SBR	NR	Chloroprene	Butyl	Fluorocarbon	Hypalon®	CPE	Nylon	PVC	Iron/Carbon Steel	Stainless Steel 304	Stainless Steel 316	Aluminum	Brass	Polypropylene
		T	K	L	S	P	C	D	D	A	H	V	M	J	Z	G	1	1	1	1	1	1
Tenol Oils	Liquid	1	1	-	-	X	1	-	-	-	-	-	-	-	1	2	1	1	1	-	-	-
Tergitol (Ethoxylates and Ethoxysulfates of Alcohol)-		1	2	-	-	-	-	-	-	-	-	-	-	-	-	-	2	1	1	-	2	-
Terpineol	Colorless Liquid or Crystal	1	1	-	-	-	-	X	X	-	X	-	2	1	2	2	-	-	-	-	-	-
Tertiary Butyl Alcohol	Colorless Liquid or Crystal	1	2	-	-	-	2	-	-	-	-	1	-	-	-	-	-	-	-	-	-	-
Tetrachlorobenzene	White Crystal	1	-	-	-	-	-	-	-	-	-	2	-	-	-	-	-	-	-	-	-	-
Tetrachloroethane (Acetylene Tetrachloride)	Colorless Liquid	1	X	X	X	X	-	X	X	-	X	1	X	X	1	X	-	-	-	-	-	-
Tetrachloroethylene	Colorless Liquid	1	-	-	-	-	-	-	-	-	-	1	-	X	-	-	-	-	-	-	-	-
Tetrachloromethane	Colorless Liquid	1	-	-	-	-	-	-	-	-	-	1	-	-	-	-	-	-	-	-	-	-
Tetrachloronaphthalene	Oily Liquid to Crystalline Solid	1	-	-	-	-	-	-	-	-	-	2	-	X	-	-	-	-	-	-	-	-
Tetradecanol	White Solid	1	-	-	-	-	-	-	-	-	-	-	-	-	-	-	-	-	-	-	-	-
Tetraethyl Lead (TEL)	Colorless Oily Liquid	1	2	-	-	X	2	X	X	X	X	1	X	-	2	1	-	-	-	-	-	-
Tetraethylene Glycol	Colorless Liquid	1	2	-	-	-	2	-	2	-	1	2	2	-	-	-	-	-	-	-	-	-
Tetrahydrofuran (THF)	Colorless Liquid	1	X	-	-	2	X	X	X	X	2	1	X	X	1	X	2	-	-	-	-	X
Tetrahydrodicyclopentadiene (JP 10) <sup>†</sup>	-	-	-	-	X	X	X	X	X	X	X	1	X	-	1	X	-	-	-	-	-	-
Tetralin	Colorless Liquid	1	-	-	X	X	X	X	X	X	X	1	X	-	2	-	-	-	-	-	-	X
Theobromo Oil (Cocoa Butter)	Liquid above 95°F (35°C)	1	1	2	2	-	2	X	X	2	-	-	-	-	-	-	1	1	1	-	-	-
THF (Tetrahydrofuran)	Colorless Liquid	1	X	-	-	2	X	X	X	X	2	1	X	X	1	X	2	-	-	-	-	X
Thiopen	-	1	-	-	-	X	X	X	X	X	2	2	-	-	-	-	-	-	-	-	-	-
Tin Tetrachloride	Colorless Liquid	1	-	-	-	-	2	-	2	X	-	-	2	-	-	-	-	-	-	-	-	-
Titanium Tetrachloride	Colorless Liquid	1	-	-	-	X	X	-	-	X	X	2	-	-	-	-	1	2	2	X	X	-
Toluene (Toluol) (Methyl Benzene)	Colorless Liquid	1	2	2	X	X	X	X	X	X	X	1	X	X	1	X	1	1	1	1	1	-
Toluene Diisocyanate (Hylene)	Yellow Liquid	1	-	-	-	2	X	X	X	X	2	X	X	-	-	-	-	-	-	-	-	-
Toluene Diisocyanate (Isocyanate)	Water White to Yellow Liquid	1	2	1	X	X	X	X	X	X	X	1	-	-	1	-	1	1	1	-	-	-
Toluidine	Yellow Liquid or White Crystal	1	-	-	-	-	X	-	X	-	X	2	X	-	-	-	-	-	-	-	-	-
Toluol (Toluene)	Colorless Liquid	1	2	2	X	X	X	X	X	X	X	1	X	X	1	X	1	1	1	1	1	-
Transformer Oil (Askarel Types) <sup>1</sup>	Liquid	1	2	2	X	X	X	X	X	X	X	1	X	2	1	X	1	1	1	-	1	2
Transformer Oil (Petroleum Type) <sup>1</sup>	Liquid	1	1	-	-	X	1	X	X	2	X	1	X	2	1	2	1	1	1	1	1	-
Transmission Fluid (Type A)	Liquid	1	1	-	-	X	1	X	X	2	X	1	-	1	2	-	1	1	1	-	1	-
Tributoxyethyl Phosphate	Yellow Liquid	1	1	X	-	2	X	X	X	-	2	-	X	X	2	-	1	-	-	X	-	-
Tributyl Phosphate	Colorless Liquid	1	1	X	-	X	X	X	X	X	X	1	X	X	-	-	1	-	-	X	-	-
Tricalcium Aluminate (Calcium Aluminate)	Crystals or Powder	1	-	-	-	-	-	-	-	1	-	-	-	-	-	-	-	-	-	-	-	-
Trichlorobenzene	White Crystal or Colorless Liquid	1	2	-	-	-	X	X	X	X	2	X	-	-	-	-	-	-	-	-	-	-
Trichloroethane 1,1,1 (Methyl Chloroform)	Colorless Liquid	1	X	-	X	X	X	X	X	X	X	1	X	X	X	-	-	-	-	-	-	-
Trichloroethylene	Colorless Liquid	1	1	X	X	X	X	X	X	X	X	1	X	2	2	-	X	-	1	X	1	-
Trichloropropane	Colorless Liquid	1	-	-	-	-	2	-	X	2	X	1	X	-	-	-	-	-	-	-	-	-
Tricresyl Phosphate	Colorless Liquid	1	-	X	-	1	X	X	X	X	2	1	X	1	1	-	1	-	2	X	-	-
Triethanolamine (TEA)	Colorless Viscous Liquid	1	1	-	-	1	2	2	2	2	2	X	2	1	-	2	-	1	1	-	1	-
Triethylamine	Colorless Liquid	1	-	-	-	2	2	X	X	-	X	2	-	-	-	-	-	-	-	-	-	-
Triethylene Glycol	Colorless Liquid	1	-	-	-	-	2	-	2	-	2	2	2	-	-	-	-	-	-	-	-	-
Trihydroxybenzoic Acid (Gallic Acid)	In Alcohol or Glycerol	1	1	1	1	X	2	2	X	2	1	-	1	X	X	X	1	1	-	-	1	-
Trimethyl Phosphate	Colorless Liquid	-	-	X	-	-	-	-	-	-	-	-	-	-	-	-	-	-	-	-	-	-
Trimethylbenzene (Mesitylene)	Liquid	1	-	-	X	X	X	X	X	X	X	1	-	-	1	X	-	-	-	-	-	-
Trinitrophenol (Picric Acid)	Yellow Crystals	1	2	2	2	2	2	2	2	2	2	1	2	-	X	1	X	1	1	X	X	1
Trioctyl Phosphate	Liquid	-	-	X	-	-	-	-	-	-	-	-	-	-	-	-	-	-	-	-	-	-
Triphenyl Phosphate	Colorless Powder	-	-	X	-	-	-	-	-	-	-	-	-	-	-	-	-	-	-	-	-	-
Tripolyphosphate (STPP), (Sodium)	White Powder	1	2	-	-	2	-	2	2	-	2	X	-	-	-	-	-	2	1	X	X	-
Trisodium Phosphate (TSP)	Colorless Crystal	1	-	-	-	1	2	2	X	2	2	1	X	-	-	-	-	-	-	-	-	-
Tung Oil	Yellow Drying Oil	1	2	-	X	X	2	X	X	X	X	1	2	X	-	2	1	1	1	1	1	-

<sup>1</sup> Petroleum hose only.

# Chemical Resistance Table

Contact Denver Product Application for recommendations for chemicals not listed.  
Phone (303) 744-5070

1 = Preferred - Constant Contact  
2 = Acceptable - Intermittent Contact  
X = Not Recommended  
- = No Data

NOTE: Ratings are for the effect on the polymer only!

Chemical	Form (at room temperature unless otherwise stated)	Gates Hose / Polymers														Couplings / Adapters					
		Chem Master™ Xtreme™ FEP	Chem Master™ Plus XLPE	Chem Master™ Plus UHMWPE	Food & Beverage Master	EPDM	NR	SBR	NR	Chloroprene	Butyl	Fluorocarbon	Hypalon®	CPE	Nylon	PVC	Iron/Carbon Steel	Stainless Steel 304	Stainless Steel 316	Aluminum	Brass
Turpentine	Liquid Oil	1	X	1	X	2	X	X	X	X	1	X	X	1	1	-	1	1	1	2	-
<b>U</b>																					
Ucon Hydrolube Types 150CP, 200CP	Liquid	1	1	-	-	1	1	-	-	1	-	-	-	1	2	1	1	1	1	1	-
Ucon Hydrolube Types 275CP, 300CP, 550CP	Liquid	1	-	-	-	-	1	X	X	-	X	1	-	-	2	2	-	-	-	-	-
Ucon M1	Liquid	1	1	-	-	1	1	-	-	-	1	-	-	-	1	2	1	1	1	1	-
Undecanol (Undecyl Alcohol)	Colorless Liquid	1	-	-	-	-	1	-	2	-	-	2	2	-	-	-	-	-	-	-	-
Undecyl Alcohol (Undecanol)	Colorless Liquid	1	-	-	-	-	1	-	2	-	-	2	2	-	-	-	-	-	-	-	-
Union Hydraulic Tractor Fluid	Brown Liquid	1	1	-	-	X	1	-	-	-	X	-	-	-	1	2	1	1	1	1	-
Urea Solution (100%)	Liquid	1	1	1	1	1	2	1	1	1	2	-	1	1	1	2	1	1	1	-	-
<b>V</b>																					
Varnish	-	1	2	-	X	X	X	X	X	X	2	X	X	1	-	2	1	1	-	2	-
Vegetable Oils	Liquids	1	-	1	2	2	-	X	X	2	X	-	1	X	1	2	1	1	1	1	-
Versilube F-50, F-44	Liquid	1	-	-	-	2	2	2	2	2	2	1	2	-	1	2	1	1	1	1	-
Vinegar	Brownish to Colorless Liquid	1	1	-	1	-	2	2	2	2	2	1	X	X	-	1	X	2	1	X	-
Vinyl Acetate	Colorless Liquid	1	1	X	2	X	X	X	X	X	2	X	X	-	-	-	1	2	1	2	-
Vinyl Chloride (Monomer)	-	1	2	-	-	X	X	X	X	X	2	X	X	-	X	2	1	1	1	X	-
Vinyl Fluoride	Colorless Gas	1	1	-	-	-	-	-	-	-	-	1	-	-	-	-	-	-	-	-	-
Vinyl Trichloride (Trichloroethane)	Colorless Liquid	1	-	-	X	X	X	X	X	X	1	X	X	X	X	-	-	-	-	-	-
Vitrea Oils	Liquid	1	1	-	-	X	1	-	-	-	X	-	-	-	1	2	1	1	1	-	-
VM&P Naptha (Mineral Spirits)	Colorless Liquid	1	1	-	X	X	1	X	X	-	X	1	X	-	1	-	1	1	2	1	-
<b>W</b>																					
Waste Paint	Liquid to Semi-Solid Paste	1	-	-	-	-	-	-	-	-	-	-	-	-	-	-	-	-	-	-	-
Water	Liquid	1	1	1	1	1	1	1	1	1	-	1	1	1	1	2	1	1	1	1	-
Water (Brine)	Liquid	1	1	-	1	2	1	1	2	1	1	1	-	1	1	-	-	-	-	-	1
Water (Deionized)	Liquid	1	-	1	1	-	-	-	-	-	1	-	-	-	-	-	-	-	-	-	-
Water (Distilled)	Liquid	1	1	1	1	1	1	1	2	1	-	1	-	1	1	-	-	-	-	-	1
Water (Potable)	Liquid	USE FDA HOSE ONLY														-	-	-	-	-	1
Water Glycols	Liquid	1	1	1	1	-	-	-	-	-	-	-	-	-	1	1	-	-	-	-	-
Water in Oil Emulsions	Liquid	1	1	1	2	-	-	-	-	-	-	-	-	-	1	1	-	-	-	-	-
White & Bagley No. 2190 Cutting Oil	Liquid	1	-	-	-	-	-	-	-	-	-	-	-	-	-	-	-	-	-	-	-
Wines	Liquid	1	2	-	1	X	X	X	X	X	1	X	1	1	-	2	2	2	1	-	-
Wood Oil	Liquid	1	1	-	-	X	1	X	X	2	X	1	2	1	1	1	-	-	-	-	-
<b>X</b>																					
Xylene (Dimethylbenzene)	Colorless Liquid	1	2	X	X	X	X	X	X	X	1	X	X	1	X	-	-	-	-	-	-
Xylenol (Dimethylphenol)	White Solid, Liquid @ 68°F (20°C)	1	1	-	-	-	-	-	-	-	1	-	X	-	-	-	-	-	-	-	-
<b>Z</b>																					
Zeric	-	1	1	-	-	X	1	-	-	-	X	-	-	-	2	2	-	-	-	-	-
Zinc Acetate	White Crystal	1	1	-	-	2	X	2	2	X	2	X	X	X	1	1	1	1	1	1	-
Zinc Chloride Solutions	Colorless to Cloudy Liquid	1	1	-	1	-	1	2	2	1	2	1	1	X	1	2	X	2	1	X	-
Zinc Chromate	Yellow Solid	1	1	-	-	-	-	-	-	-	-	1	X	-	-	-	1	1	-	-	-
Zinc Hydrate	-	1	-	-	-	-	-	-	-	-	-	-	-	X	-	1	-	-	-	-	-
Zinc Oxide	White or Gray Powder	1	-	-	-	-	-	-	-	-	-	-	-	X	-	1	-	-	-	-	-
Zinc Sulfate Solutions	Colorless to Cloudy Liquid	1	1	-	-	2	2	X	X	2	2	-	2	X	2	2	X	2	1	X	-

² Aircraft fueling hose only for fueling operations.

- AGRICULTURE
- AIR BREATHING
- AIR DUCT
- AIR AND MULTI-PURPOSE
- CHEMICAL
- FOOD AND BEVERAGE
- MARINE AND ENGINE
- MATERIAL HANDLING
- MINING
- OILFIELD
- PETROLEUM
- PRESSURE WASH AND WASHDOWN
- STEAM
- WATER
- CLAMPS
- COUPLINGS AND FERRULES
- HOSE FINDER





# LIMITED WARRANTY

Goods are warranted to be free from defects in material or workmanship for the life of the Goods (or the published recommended replacement interval specified by Gates). Gates will replace or repair, at its option, any Goods proved defective in material or workmanship during the warranty period. This is the sole remedy for breach of warranty. Color fade and color difference is not warranted. This warranty is void if the defect is caused by improper installation, use or maintenance of the Goods, or used for racing or competition. Goods are not warranted to comply with laws that may apply to uses of the Goods not stated in related materials, e.g., use in manned or unmanned aviation or life support applications. **ALL OTHER WARRANTIES, EXPRESS OR IMPLIED, INCLUDING, BUT NOT LIMITED TO WARRANTIES OF MERCHANTABILITY AND FITNESS FOR A PARTICULAR PURPOSE, ARE EXPRESSLY DISCLAIMED. FAILURE TO REPLACE TIMING BELTS OR OTHER GATES PRODUCTS AS SPECIFIED MAY RESULT IN CATASTROPHIC ENGINE OR EQUIPMENT DAMAGE, FOR WHICH GATES DISCLAIMS ALL RESPONSIBILITY, TO THE EXTENT PERMITTED BY APPLICABLE LAW.**

Some states do not allow the exclusion or limitation of incidental or consequential damages, and some states do not allow limitations on how long an implied warranty lasts, so the above limitation and exclusion may not apply to you. This warranty gives you specific legal rights, and you may also have other rights which vary from state to state. For the latest Limited Warranty information go to [www.gates.com/warranty](http://www.gates.com/warranty).

## SERVICE LIFE

All rubber products, including Industrial Hose assemblies, have a limited life on a given application. Assuming the correct hose has been selected for the application, this service life can be adversely affected by many variable conditions.

The major ones are:

- › Exposure to severe external abuse such as kinking, bending, high end pull, crushing or abrasion.
  - › Exposure to higher-than-rated working pressures or to high surge pressures.
  - › Exposure to higher-than rated temperatures.
  - › Misapplication or exposure to corrosive liquids or gases outside the range of suitable applications.
1. **EXTERNAL ABUSE** Hoses should be placed where they will not be run over by equipment or subjected to high end pull. Hoses should not be bent below recommended minimum bend radius. This could result in kinking the hose or reducing its pressure resistance. Large diameter hoses also may require additional support to reduce external abuse.
  2. **HOSE & SYSTEM PRESSURES** In establishing and determining pressures related to hose and the systems to which they are applied, it is necessary to consider separately the characteristics of the hose and the system.
    - › The system (or device or application) can have several pressures depending on pressure sources and surges imposed by the operator or mechanical components.
    - › A given hose has a fixed characteristic with respect to the pressure it can withstand (and how it is applied) and still give satisfactory life.
  3. **HIGH TEMPERATURES** The allowable temperature ranges for industrial hoses are shown on the High Temperature Ranges page. These are for product temperatures and should not be exceeded. High temperatures can degrade rubber stocks very quickly resulting in short service life. Where external temperatures are higher than normal ambient, contact your Gates field representative for recommendations.
  4. **MISAPPLICATION** All industrial hoses are designed for a certain specific application or related application. They should not be used for any other applications.
  5. **HOSE INFORMATION** Refer to the following pages for details of hose construction and physical characteristics. These are shown in the data pages and include such items as rated working pressure, vacuum rating, minimum bend radius and static conductivity.
  6. **INTERNAL ABRASION** For applications of a highly abrasive nature where the hose makes one or more bends, hose should be rotated 90° periodically to lengthen service life.

The hose manufacturer established, through design and testing, the recommended rated working pressure for the hose. It is the responsibility of the user to accurately determine the system pressure. Steady state pressure can be measured readily by gauges. Surges are difficult to measure and may require the use of electronic pressure pickup devices. Also, surge values depend on so many variables that a series of tests are usually required to obtain a valid set of readings. However, if there are extreme surges in the normal operation, or if there is the likelihood of abnormal operation of the system, the magnitude must be determined.

Considering the recommended rated working pressure of the HOSE and the various pressures of the SYSTEM, the hose is matched to the system using proper application engineering principles. End terminations may reduce the rated working pressure of hose assemblies. Refer to coupling manufacturer for recommendations or consequential damages, and some states do not allow limitations on how long an implied warranty lasts, so the above limitation and exclusion may not apply to you. This warranty gives you specific legal rights, and you may also have other rights which vary from state to state.

### WARNING

Gates Corporation recommends industrial hoses for normal service as described in this catalog. Other applications should be referred to your respective marketing representative.

**In any application, there may be inherent risk of bodily injury or property damage and the user is responsible for implementation of adequate safety precautions. It is the responsibility of the person supplying the hose to advise the user of proper instructions for the adequate safe use and or precautions and to warn the user of consequences of failure to heed such instruction. Should a hose assembly fail during use because of excessive pressure, injurious and/or damaging chemicals, elevated temperature materials, explosives or flammable materials, then serious bodily injury or destruction of property could result from impelled couplings, whipping hose, high pressure or high velocity discharge, chemical contact, high temperature materials, explosion or fire.**

In known high risk areas, it is recommended that hose inspections be performed at frequent intervals related to the risk factor. Hose with obvious damage should be scrapped and replaced. These inspections should include tube and cover conditions, leaking or slipped couplings and proof test.

Detailed information concerning storage, care and maintenance may be found in the Hose Handbook published by Association for Rubber Products Manufacturers 1901 Pennsylvania Avenue, N.W., Washington, D.C. 20006 and in SAE Recommended Practices J1273.

### IMPORTANT

Gates recommends only those applications of products specified in Gates product literature. Gates disclaims any liability for use of its products in applications other than those for which they were designed.

Do not use Gates hose or couplings on aircraft propeller or rotor drive systems or in-flight accessory drives. Gates products are not designed or intended for aircraft use.



# INDUSTRIAL HOSE FAMILY

AGRICULTURE
AIR BREATHING
AIR DUCT
AIR AND MULTIPURPOSE
CHEMICAL
FOOD AND BEVERAGE
MARINE AND ENGINE
MATERIAL HANDLING
MINING
OILFIELD
PETROLEUM
PRESSURE WASH AND WASHDOWN
STEAM
WATER
CLAMPS
COUPLINGS AND FERRULES
HOSE FINDER
CHEMICAL RESISTANCE TABLE

## AG MASTER™



## AIR MASTER™



## BULK MASTER™



## BLACK GOLD™



## CHEM MASTER™



## FOOD MASTER™



## FUEL MASTER™

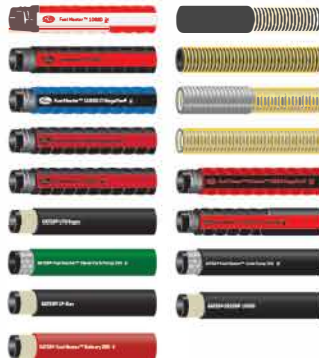

## MARINE MASTER™



## MINE MASTER™



## PLANT MASTER™



## WATER MASTER™

